



SPARE PARTS AND ACCESSORIES

- ✓ for Bioreactors
- ✓ and Fermenters



Visit our Website
www.bbi-biotech.com

innovation for biotech



Exhaust

Exhaust filter housings	2
Exhaust fittings	4
Exhaust coolers	8

Adapters

Screw-down nuts	18
Thread adapters	22
Clamp adapters	31
Probe adapters	39
Triclamp adapters	44

Ventilation and Aeration

Aeration baskets	50
Frits	57
L-Spargers	74
Draft tubes	86
Microspargers	90
Ringspargers	97

Blind plugs

Blind plugs autoclavable	140
Blind plugs in-situ	146

Harvesting

Bottom drain valves	161
Harvest pipes	164
Spinfilters	211

Addition

Addition ports	225
Inoculation ports	244
Headpieces	245
Media bottles	304
Laboratory bottles	323
Membrane holders	356
STT couplings	359
Sacovas	363
Screw caps	375
Sterile sleeves	390

Culture vessels

Equipped glass vessels	394
Lids	415
Lid screws	427
Bottle holders	433
Vessels	443

O-rings for lid	461
Stainless steel stands	466
Assembly accessories	
Consumable starter sets	475
Gaskets	476
Membranes	487
Material for assembly	495
Consumable sets	518
Sampling	
Manual Sampling	527
Sampling valves	531
Stirring and mixing	
3-bladed segment impellers	534
Condensate storage vessels	558
Couplings	560
Motor adapters	563
Motors	565
Paddle impellers	571
Rushton impellers	585
Stirrer shafts	608
Special impeller designs	627
Baffles & baffle cages	638
Probes and sensors	
Level and antifoam probes	647
Redox probes	655
Oxygen probes	659
Probe cables	679
Other probes	692
pH probes	695
Temperature control	
Heating jackets	705
Cooling fingers	723
Plate heat exchanger	727
Pt100 casings	731
Pt100 sensors	743
Temperature control units	748
Uncategorized	
Filter	761
Pressure gauges	768
O-rings for accessories	770
Sight glasses	784

Tubes	786
Coupling nuts	818
Other	822

Alle / Verkaufsartikel / Accessories / Exhaust

Highfoam-Adapter ID38; TC50,5; 11 mm; 19 mm Rd 28 x 1/8



bbi Scancode	BBI-43930601
Manufacturer	bbi-biotech GmbH
Internal Thread	Rd 28 x 1/8; M 30 x 1
External Thread	M 30 x 1
Material Certificate	3.1
Country of Origin	DE 
Weight	1.9 kg

Components

Description:



To the Shop:



Alle / Verkaufsartikel / Accessories / Exhaust / Exhaust filter housings

Exhaust air filter housing 5" with M 30 x 1



bbi Scancode	BBI-43930501
Manufacturer	bbi-biotech GmbH
Material Certificate	3.1, Rauigkeit, FDA
Country of Origin	DE 
Weight	1.1 kg

Components	
Related Products	Abluftfiltergehäuse 5" mit Kondensatablauf (BBI-43930502)
Description:	



To the Shop:



Alle / Verkaufsartikel / Accessories / Exhaust / Exhaust filter housings

Abluftfiltergehäuse 5" mit Kondensatablauf



bbi Scancode	BBI-43930502
Country of Origin	DE 

Components	
Related Products	Exhaust air filter housing 5" with M 30 x 1 (BBI-43930501)
Description:	



To the Shop:



Alle / Verkaufsartikel / Accessories / Exhaust / Exhaust fittings

Universal adapter Pg 13.5



bbi Scancode	BBI-43930001
Manufacturer	bbi-biotech GmbH
External Thread	Pg 13,5
Installation Depth	32 mm
Material Certificate	3.1, Rauigkeit, FDA
Country of Origin	DE 
HS-Code	73269098
Weight	0.06 kg
Material	Stainless steel 316L EPDM black

Components	1x universal adapter, 1x flat seal with hole [BBI-44130214]
Consumables	Flat seal with hole for 12 mm ports (package of 5 pieces) (BBI-44130214)
Related Products	1-way addition port 4 mm, PG 13.5 (BBI-43630254) 1-way addition port 6 mm, PG 13.5 (BBI-43630255) Universal adapter 6-4 (BBI-43930003)

Description:

- For the addition of inoculation cultures or additional media to a bioreactor
- For autoclavable vessels
- With 1 hose nozzle
- For use with autoclavable feeding bottles



To the Shop:



Alle / Verkaufsartikel / Accessories / Exhaust / Exhaust fittings

Universal adapter 8.5



bbi Scancode	BBI-43930002
Manufacturer	bbi-biotech GmbH
External Thread	M 10 x 1
Material Certificate	3.1, Rauigkeit, FDA
Country of Origin	DE 
HS-Code	73269098
Weight	0.02 kg
Material	Stainless steel 316L EPDM black

Components	1x universal adapter, 1x O-ring [BBI-45100011], 1x coupling nut M 10 x 1 (flat) [BBI-44130009]
Consumables	O-ring for items to install in 11 mm ports (package of 10 pieces) (BBI-45100011)
Related Products	Universal adapter 6-4 (BBI-43930003) Universal adapter 6-6 (BBI-43930101) Universal adapter Pg 13.5 (BBI-43930001)

Description:

- To connect corrective solution supply or to remove exhaust from culture vessel
- Installation in Ø 11 mm- lid port
- Hose nozzle (outside of the vessel) Ø = 8.5 mm
- Also available as universal adapter with hose noozles Ø = 4 mm / 6 mm



To the Shop:



Alle / Verkaufsartikel / Accessories / Exhaust / Exhaust fittings

Universal adapter 6-4



bbi Scancode	BBI-43930003
Manufacturer	bbi-biotech GmbH
External Thread	M 10 x 1
Material Certificate	3.1, Rauigkeit, FDA
Country of Origin	DE 
HS-Code	73269098
Weight	0.02 kg
Material	Stainless steel 316L EPDM black

Components	1x universal adapter, 1x O-ring [BBI-45100011], 1x coupling nut M 10 x 1 (flat) [BBI-44130009]
Consumables	O-ring for items to install in 11 mm ports (package of 10 pieces) (BBI-45100011)
Related Products	Universal adapter 6-6 (BBI-43930101) Universal adapter 8.5 (BBI-43930002) Universal adapter Pg 13.5 (BBI-43930001)

Description:

- To connect corrective solution supply or to remove exhaust from culture vessel
- Installation in Ø 11 mm- lid port
- Hose nozzle (outside of the vessel) Ø = 6 mm
- Hose nozzle (inside of the vessel) Ø = 4 mm
- Also available as universal adapter with hose noozles Ø = 8 mm



Alle / Verkaufsartikel / Accessories / Exhaust / Exhaust fittings

Universal adapter 6-6



bbi Scancode	BBI-43930101
Manufacturer	bbi-biotech GmbH
External Thread	M 10 x 1
Material Certificate	3.1, Rauigkeit, FDA
Country of Origin	DE 
HS-Code	73269098
Material	Stainless steel 316L EPDM black

Components	1x universal adapter, 1x O-ring [BBI-45100011], 1x coupling nut M 10 x 1 (flat) [BBI-44130009]
Consumables	O-ring for items to install in 11 mm ports (package of 10 pieces) (BBI-45100011)
Related Products	Universal adapter 6-4 (BBI-43930003) Universal adapter 8.5 (BBI-43930002) Universal adapter Pg 13.5 (BBI-43930001)

Description:

- To connect corrective solution supply or to remove exhaust from culture vessel
- Hose nozzles both side
- For use with autoclavable feeding bottles
- s Ø = 6 mm
- Installation in Ø 11 mm- lid port



To the Shop:



Alle / Verkaufsartikel / Accessories / Exhaust / Exhaust coolers

2 L exhaust cooler, M 26 x 1



bbi Scancode	BBI-43930005
Manufacturer	bbi-biotech GmbH
External Thread	M 26 x 1
Material Certificate	3.1, FDA
Country of Origin	DE 
HS-Code	73269098
Weight	0.72 kg
Material	Stainless steel 316L EPDM black silicone

Components	1x exhaust air cooler with hose connections; 1x o-ring [BBI-45100015]
Consumables	Replacement-connection-kit exhaust cooler (BBI-43930201) O-ring for items to install in M 26 x 1 ports (package of 10 pieces) (BBI-45100015) Gasket TC25 for hose connector exhaust cooler (package of 5 pieces) (BBI-45100302)
Related Products	2 L exhaust cooler, Pg 13.5 (BBI-43930010) 5-10 L exhaust cooler, M 26 x 1 (BBI-43930007) Blind plug for 19 mm ports M 26 x 1 (BBI-44130201)

Description:

- For the reduction of humidity level in exhaust
- Jacketed vessel for cooling water or other cooling fluids
- For 2 L vessels
- Reduces the loss of fluids from the bioreactor
- Reduces the risk of the exhaust filter getting blocked
- Delivery without filter (available separately)
- With fabric-reinforced silicone tubes and quick connect couplings



To the Shop:



Alle / Verkaufsartikel / Accessories / Exhaust / Exhaust coolers

5-10 L exhaust cooler, M 26 x 1



bbi Scancode	BBI-43930007
Manufacturer	bbi-biotech GmbH
External Thread	M 26 x 1
Material Certificate	3.1, FDA
Country of Origin	DE 
HS-Code	73269098
Weight	0.9 kg
Material	Stainless steel 316L EPDM black silicone

Components	1x exhaust air cooler with hose connections; 1x o-ring [BBI-45100015]
Consumables	Replacement-connection-kit exhaust cooler (BBI-43930201) O-ring for items to install in M 26 x 1 ports (package of 10 pieces) (BBI-45100015) Gasket TC25 for hose connector exhaust cooler (package of 5 pieces) (BBI-45100302)
Related Products	2 L exhaust cooler, M 26 x 1 (BBI-43930005) 5-10 L exhaust cooler, Pg 13.5 (BBI-43930012) Blind plug for 19 mm ports M 26 x 1 (BBI-44130201)

Description:

- For the reduction of humidity level in exhaust
- Jacketed vessel for cooling water or other cooling fluids
- For 5 L and 10 L vessels
- Reduces the loss of fluids from the bioreactor
- Reduces the risk of the exhaust filter getting blocked
- Delivery without filter (available separately)
- With fabric-reinforced silicone tubes and quick connect couplings



To the Shop:



Alle / Verkaufsartikel / Accessories / Exhaust / Exhaust coolers

0.5-1 L exhaust cooler, M 26 x 1



bbi Scancode	BBI-43930008
Manufacturer	bbi-biotech GmbH
External Thread	M 26 x 1
Material Certificate	3.1, FDA
Country of Origin	DE 
HS-Code	73269098
Weight	0.5 kg
Material	Stainless steel 316L EPDM black silicone

Components	1x exhaust air cooler with hose connections; 1x o-ring [BBI-45100015]
Consumables	Replacement-connection-kit exhaust cooler (BBI-43930201) O-ring for items to install in M 26 x 1 ports (package of 10 pieces) (BBI-45100015)
Related Products	0.5 L lid (BBI-44430002) 0.5-1 L exhaust cooler, Pg 13.5 (BBI-43930009) 5-10 L exhaust cooler, Pg 13.5 (BBI-43930012)

Description:

- For the reduction of humidity level in exhaust
- Jacketed vessel for cooling water or other cooling fluids
- For 0.5 L and 1 L vessels
- Reduces the loss of fluids from the bioreactor
- Reduces the risk of the exhaust filter getting blocked
- Delivery without filter (available separately)
- With fabric-reinforced silicone tubes and quick connect couplings



To the Shop:



Alle / Verkaufsartikel / Accessories / Exhaust / Exhaust coolers

0.5-1 L exhaust cooler, Pg 13.5



bbi Scancode	BBI-43930009
Manufacturer	bbi-biotech GmbH
External Thread	Pg 13,5
Material Certificate	3.1, FDA
Country of Origin	DE 
HS-Code	73269098
Weight	0.35 kg
Material	Stainless steel 316L EPDM black silicone

Components	1x exhaust air cooler with hose connections; 1x seal [BBI-44130214]
Consumables	Replacement-connection-kit exhaust cooler (BBI-43930201) Flat seal with hole for 12 mm ports (package of 5 pieces) (BBI-44130214)
Related Products	0.5 L double-wall vessel, complete with accessories MO without sensors (BBI-44438005) 0.5-1 L exhaust cooler, M 26 x 1 (BBI-43930008) 1 L double-wall vessel, complete with accessories MO without sensors (BBI-44438010)

Description:

- For the reduction of humidity level in exhaust
- Jacketed vessel for cooling water or other cooling fluids
- For 0.5 L vessels
- Reduces the loss of fluids from the bioreactor
- Reduces the risk of the exhaust filter getting blocked
- For Pg 13.5 port
- Delivery without filter (available separately)
- With fabric-reinforced silicone tubes and quick connect couplings



To the Shop:



Alle / Verkaufsartikel / Accessories / Exhaust / Exhaust coolers

2 L exhaust cooler, Pg 13.5



bbi Scancode	BBI-43930010
Manufacturer	bbi-biotech GmbH
External Thread	Pg 13,5
Material Certificate	3.1, FDA
Country of Origin	DE 
HS-Code	73269098
Material	Stainless steel 316L EPDM black silicone

Components	1x exhaust air cooler with hose connections; 1x seal [BBI-44130214]
Related Products	2 L exhaust cooler, M 26 x 1 (BBI-43930005) Blind plug Pg 13.5 (BBI-44130206) Replacement-connection-kit exhaust cooler (BBI-43930201)

Description:

- For the reduction of humidity level in exhaust
- For installation in Pg 13.5 lid port
- Jacketed vessel for cooling water or other cooling fluids
- For 2 L vessels
- Reduces the loss of fluids in bioreactor
- Reduces the risk of the exhaust filter getting blocked
- With fabric-reinforced silicone tubes and quick connect couplings



To the Shop:



Alle / Verkaufsartikel / Accessories / Exhaust / Exhaust coolers

Exhaust cooler extension kit - M26 x 1



bbi Scancode	BBI-43930011
Manufacturer	bbi-biotech GmbH
External Thread	M 26 x 1
Material Certificate	3.1, FDA
Country of Origin	DE 
HS-Code	73269098
Weight	0.39 kg
Material	Stainless steel 316L EPDM black silicone

Components	1x extensio kit, 1x o-ring [BBI-45100015]
Related Products	0.5-1 L exhaust cooler, M 26 x 1 (BBI-43930008) 2 L exhaust cooler, M 26 x 1 (BBI-43930005) 5-10 L exhaust cooler, M 26 x 1 (BBI-43930007)
Description: <ul style="list-style-type: none"> • The exhaust cooler can be repositioned with this extension kit and can be used within smaller autoclaves with the culture vessel • Reduces the necessary height inside the autoclave 	



Alle / Verkaufsartikel / Accessories / Exhaust / Exhaust coolers

5-10 L exhaust cooler, Pg 13.5



bbi Scancode	BBI-43930012
Manufacturer	bbi-biotech GmbH
External Thread	Pg 13,5
Material Certificate	3.1, FDA
Country of Origin	DE 
HS-Code	73269098
Weight	0.73 kg
Material	Stainless steel 316L EPDM black silicone

Components	1x exhaust air cooler with hose connections; 1x seal [BBI-44130214]
Related Products	5-10 L exhaust cooler, M 26 x 1 (BBI-43930007) Exhaust cooler extension kit - M26 x 1 (BBI-43930011) Replacement-connection-kit exhaust cooler (BBI-43930201)

Description:

- For the reduction of humidity level in exhaust
- For installation in Pg 13.5 lid port
- Jacketed vessel for cooling water or other cooling fluids
- For 5 L or 10 L vessels
- Reduces the loss of fluids in bioreactor
- Reduces the risk of the exhaust filter getting blocked
- With fabric-reinforced silicone tubes and quick connect couplings



Alle / Verkaufsartikel / Accessories / Exhaust / Exhaust coolers

0.25 L exhaust cooler (to weld)



bbi Scancode	BBI-43930013
Manufacturer	bbi-biotech GmbH
Material Certificate	3.1, FDA
Country of Origin	DE 
HS-Code	73269098
Material	Stainless steel 316L EPDM black silicone

Components	1x Abluftkühler mit Schlauchanschlüssen
Related Products	0,25 L dip tube for harvesting, fix, ID = 4 mm (BBI-43630026) 0,25 L lid (BBI-44430352) 0.5-1 L exhaust cooler, M 26 x 1 (BBI-43930008)

Description:

- For the reduction of humidity level in exhaust
- Forwelding to the lid
- Jacketed vessel for cooling water or other cooling fluids
- For 0.25 L vessels
- Reduces the loss of fluids in bioreactor
- Reduces the risk of the exhaust filter getting blocked
- With fabric-reinforced silicone tubes and quick connect couplings



Alle / Verkaufsartikel / Accessories / Exhaust / Exhaust coolers

Exhaust cooler C30 (10 L in-situ)



bbi Scancode	BBI-43930021
Manufacturer	bbi-biotech GmbH
Material Certificate	3.1, FDA
Country of Origin	DE 
HS-Code	73269098

Description:



To the Shop:



Alle / Verkaufsartikel / Accessories / Exhaust / Exhaust coolers

Replacement-connection-kit exhaust cooler



bbi Scancode	BBI-43930201
Manufacturer	bbi-biotech GmbH
Country of Origin	DE 

Components	1x silicone hose; 2x connectors; 2x quick couplings; 6x hose clamp
Related Products	0.5-1 L exhaust cooler, M 26 x 1 (BBI-43930008) 2 L exhaust cooler, M 26 x 1 (BBI-43930005) 5-10 L exhaust cooler, M 26 x 1 (BBI-43930007)
Description: With fabric-reinforced silicone tubes and quick connect couplings	



To the Shop:



Alle / Verkaufsartikel / Accessories / Adapters / Screw-down nuts

Screw-down nut 19 mm Rd 28 x 1/8



bbi Scancode	BBI-44130006
Manufacturer	bbi-biotech GmbH
External Thread	Rd 28 x 1/8
Material Certificate	3.1, Rauigkeit
Country of Origin	DE 
HS-Code	73269098
Material	Stainless steel 316L

Components	1x screw down nut
Related Products	Blind plug Rd 28 x 1/8 (BBI-44130205) Screw-down nut 19 mm M 26 x 1 (BBI-44130007) Screw-down nut M 16 x 1.5 (BBI-44130008)
Description: <ul style="list-style-type: none"> • Screw-down nut • Inner diameter 20.5 mm • Spare part for e.g. inoculation needles, pressure sensors 	



To the Shop:



Alle / Verkaufsartikel / Accessories / Adapters / Screw-down nuts

Screw-down nut 19 mm M 26 x 1



bbi Scancode	BBI-44130007
Manufacturer	bbi-biotech GmbH
External Thread	M 26 x 1
Material Certificate	3.1, Rauigkeit
Country of Origin	DE 
HS-Code	73269098
Material	Stainless steel 316L

Components	1x screw down nut
Related Products	Blind plug for 19 mm ports M 26 x 1 (BBI-44130201) Screw-down nut 19 mm Rd 28 x 1/8 (BBI-44130006) Screw-down nut M 16 x 1.5 (BBI-44130008)
<p>Description:</p> <ul style="list-style-type: none"> • Screw-down nut • Inner diameter 22 mm • For mounting on the bioreactor lid • Spare part for e.g. inoculation needles, pressure sensors 	



Alle / Verkaufsartikel / Accessories / Adapters / Screw-down nuts

Screw-down nut M 16 x 1.5



bbi Scancode	BBI-44130008
Manufacturer	bbi-biotech GmbH
External Thread	M 16 x 1,5
Material Certificate	3.1, Rauigkeit
Country of Origin	DE 
HS-Code	73269098
Material	Stainless steel 316L

Components	1x screw down nut
Related Products	Screw-down nut 19 mm M 26 x 1 (BBI-44130007) Screw-down nut 19 mm Rd 28 x 1/8 (BBI-44130006)
<p>Description:</p> <ul style="list-style-type: none"> • All-purpose nut for fixating • For example for inoculation needles, pressure sensors, etc. • bioPROBE probe extension spare part 	



Alle / Verkaufsartikel / Accessories / Adapters / Screw-down nuts

M 30 x 1 socket with nuts



bbi Scancode	BBI-44730001
Manufacturer	bbi-biotech GmbH
External Thread	M 30 x 1
Country of Origin	DE 
HS-Code	73269098

Components	1x socket with coupling nut
Related Products	Exhaust air filter housing 5" with M 30 x 1 (BBI-43930501) Triclamp adapter 34 with internal thread M 30 x 1 (BBI-44130104) Triclamp adapter M 30 x 1 with nut (BBI-44130105)
Description:	



To the Shop:



Alle / Verkaufsartikel / Accessories / Adapters / Thread adapters

Angled adapter Pg 13,5 to Pg 13,5



bbi Scancode	BBI-43930000
Manufacturer	bbi-biotech GmbH
Internal Thread	Pg 13,5
External Thread	Pg 13,5
Material Certificate	3.1, Rauigkeit, FDA
Country of Origin	DE 
HS-Code	73269098
Material	Stainless steel 316L EPDM black

Components	1x angled adapter; 1x seal [BBI-44130214]
Related Products	0.5-1 L exhaust cooler, Pg 13.5 (BBI-43930009) 2 L exhaust cooler, Pg 13.5 (BBI-43930010) Blind plug Pg 13.5 (BBI-44130206)
Description: <ul style="list-style-type: none"> • E.g. for use with exhaust cooler for 12 mm port Pg 13.5 • Angular for more space in the middle of the headplate 	



Alle / Verkaufsartikel / Accessories / Adapters / Thread adapters

Adapter M 26 x 1 to Rd 28 x 1/8



bbi Scancode	BBI-44130097
Manufacturer	bbi-biotech GmbH
Internal Thread	Rd 28 x 1/8
External Thread	M 26 x 1
Material Certificate	3.1, Rauigkeit
Country of Origin	DE 
HS-Code	73269098
Material	Stainless steel 316L

Components	1x adapter
Related Products	<p>Reducing adapter M 38 x 1.5 to M 26 x 1 (BBI-44130103)</p> <p>Reducing adapter Rd 28 x 1/8 to G 1/2 (BBI-44130100)</p> <p>Reducing adapter Rd 28 x 1/8 to G 1/4 (BBI-44130099)</p>
<p>Description:</p> <ul style="list-style-type: none"> • Adapter • Electropolished stainless steel • Zum Einbau von Produkten mit Rd 28 x 1/8-Gewinde in M 26 x 1-Ports • Spare part for bioreactors 	



Alle / Verkaufsartikel / Accessories / Adapters / Thread adapters

Reducing adapter Rd 28 × 1/8 to G 1/8



bbi Scancode	BBI-44130098
Manufacturer	bbi-biotech GmbH
Internal Thread	G 1/8
External Thread	Rd 28 × 1/8
Material Certificate	3.1, Rauigkeit
Country of Origin	DE 
HS-Code	73269098
Material	Stainless steel 316L

Components	1x reducing adapter; 1x o-ring
Related Products	Adapter Rd 28 × 1/8 to M 26 × 1 (BBI-44130112) Reducing adapter M 38 × 1.5 to M 26 × 1 (BBI-44130103) Reducing adapter Rd 28 × 1/8 to G 1/4 (BBI-44130099)
<p>Description:</p> <ul style="list-style-type: none"> • Reduction adapter • For installing products with a G 1/8 thread in Rd 28 x 1/8 ports • Electropolished stainless steel • Adapter kompatibel mit Minimes Form F 	



Alle / Verkaufsartikel / Accessories / Adapters / Thread adapters

Reducing adapter Rd 28 × 1/8 to G 1/4



bbi Scancode	BBI-44130099
Manufacturer	bbi-biotech GmbH
Internal Thread	G 1/4
External Thread	Rd 28 × 1/8
Material Certificate	3.1, Rauigkeit
Country of Origin	DE 
HS-Code	73269098
Material	Stainless steel 316L

Components	1x reducing adapter; 1x o-ring
Related Products	Adapter Rd 28 × 1/8 to M 26 × 1 (BBI-44130112) Reducing adapter M 38 × 1.5 to M 26 × 1 (BBI-44130103) Reducing adapter Rd 28 × 1/8 to G 1/2 (BBI-44130100)
<p>Description:</p> <ul style="list-style-type: none"> • Reduction adapter • For installing products with a G 1/4 thread in Rd 28 x 1/8 ports • Electropolished stainless steel • Adapter kompatibel mit Minimes Form F 	



Alle / Verkaufsartikel / Accessories / Adapters / Thread adapters

Reducing adapter Rd 28 × 1/8 to G 1/2



bbi Scancode	BBI-44130100
Manufacturer	bbi-biotech GmbH
Internal Thread	G 1/2
External Thread	Rd 28 × 1/8
Material Certificate	3.1, Rauigkeit
Country of Origin	DE 
HS-Code	73269098
Weight	0.06 kg
Material	Stainless steel 316L

Components	1x reducing adapter; 1x o-ring
Related Products	Adapter Rd 28 × 1/8 to M 26 × 1 (BBI-44130112) Reducing adapter M 38 × 1.5 to M 26 × 1 (BBI-44130103) Reducing adapter Rd 28 × 1/8 to G 1/4 (BBI-44130099)
<p>Description:</p> <ul style="list-style-type: none"> • Reduction adapter • For installing products with a G 1/2 thread in Rd 28 × 1/8 ports • Electropolished stainless steel 	



Alle / Verkaufsartikel / Accessories / Adapters / Thread adapters

Reducing adapter Rd 28 × 1/8 to G 3/4



bbi Scancode	BBI-44130101
Manufacturer	bbi-biotech GmbH
Internal Thread	G 3/4
External Thread	Rd 28 × 1/8
Material Certificate	3.1, Rauigkeit
Country of Origin	DE 
HS-Code	73269098
Weight	0.09 kg
Material	Stainless steel 316L

Components	1x reducing adapter; 1x o-ring
Related Products	Adapter Rd 28 × 1/8 to M 26 × 1 (BBI-44130115) Adapter Rd 28 × 1/8 to M 26 × 1 (BBI-44130112) Reducing adapter Rd 28 × 1/8 to G 1/2 (BBI-44130100)
<p>Description:</p> <ul style="list-style-type: none"> • Reduction adapter • For installing products with a G 3/4 thread in Rd 28 × 1/8 ports • Electropolished stainless steel 	



Alle / Verkaufsartikel / Accessories / Adapters / Thread adapters

Reducing adapter M 38 x 1.5 to M 26 x 1



bbi Scancode	BBI-44130103
Manufacturer	bbi-biotech GmbH
Internal Thread	M 26 x 1
External Thread	M 38 x 1,5
Material Certificate	3.1, Rauigkeit, FDA
Country of Origin	DE 
HS-Code	73269098
Weight	0.4 kg
Material	Stainless steel 316L

Components	1x reducing adapter; 1x o-ring
Related Products	Adapter Rd 28 x 1/8 to M 26 x 1 (BBI-44130112) Blind plug M 38 x 1.5 (BBI-44130208) Blind plug for 19 mm ports M 26 x 1 (BBI-44130201)
Description: <ul style="list-style-type: none"> • Reduction adapter • For installing products with M 26 x 1 thread in M 38 x 1.5 ports • Electropolished stainless steel 	



To the Shop:



Alle / Verkaufsartikel / Accessories / Adapters / Thread adapters

Adapter Rd 28 × 1/8 to M 26 × 1



bbi Scancode	BBI-44130112
Manufacturer	bbi-biotech GmbH
Internal Thread	M 26 × 1
External Thread	Rd 28 × 1/8
Material Certificate	3.1, Rauigkeit
Country of Origin	DE 
HS-Code	73269098
Weight	0.73 kg
Material	Stainless steel 316L

Components	1x adapter
Related Products	Reducing adapter M 38 × 1.5 to M 26 × 1 (BBI-44130103) Reducing adapter Rd 28 × 1/8 to G 1/2 (BBI-44130100) Reducing adapter Rd 28 × 1/8 to G 1/4 (BBI-44130099)
Description: <ul style="list-style-type: none"> • Adapter • Electropolished stainless steel • For installing products with M 26 × 1 thread in Rd 28 × 1/8 ports • Spare part for bioreactors 	



To the Shop:



Alle / Verkaufsartikel / Accessories / Adapters / Thread adapters

Adapter Rd 28 × 1/8 to M 26 × 1



bbi Scancode	BBI-44130115
Manufacturer	bbi-biotech GmbH
Internal Thread	M 26 × 1
External Thread	Rd 28 × 1/8
Material Certificate	3.1, Rauigkeit
Country of Origin	DE 
HS-Code	73269098
Material	Stainless steel 316L

Components	1x adapter
Related Products	Adapter Rd 28 × 1/8 to M 26 × 1 (BBI-44130112) Reducing adapter M 38 × 1.5 to M 26 × 1 (BBI-44130103) Reducing adapter Rd 28 × 1/8 to G 1/2 (BBI-44130100)
Description: <ul style="list-style-type: none"> • Adapter • Electropolished stainless steel • For installing products with M 26 × 1 thread in Rd 28 × 1/8 ports • Spare part for bioreactors 	



To the Shop:



Alle / Verkaufsartikel / Accessories / Adapters / Clamp adapters

Adapter for 12 mm level and antifoam probes in Rd 28 × 1/8 ports



bbi Scancode	BBI-44630100
Manufacturer	bbi-biotech GmbH
External Thread	Rd 28 × 1/8
Material Certificate	3.1, Rauigkeit, FDA
Country of Origin	DE 
HS-Code	73269098
Weight	0.21 kg
Material	Stainless steel 316L EPDM black

Components	1x adapter, 1x o-ring
Related Products	<p>Adapter for 12 mm level and antifoam probes in M 26 × 1 ports (BBI-44630107)</p> <p>Adapter for 14 mm level and antifoam probes in Rd 28 × 1/8 ports (BBI-44630101)</p> <p>Adapter for 6 mm level probes or dip tubes for harvesting in Pg 13.5 ports (BBI-44630106)</p>
<p>Description:</p> <ul style="list-style-type: none"> • For the installation of antifoam or level probes in the headplate of a bioreactor • For probes with diameter 12 mm • Adapter without probe • For installation in Rd 28 × 1/8 ports 	



Alle / Verkaufsartikel / Accessories / Adapters / Clamp adapters

Adapter for 14 mm level and antifoam probes in Rd 28 × 1/8 ports



bbi Scancode	BBI-44630101
Manufacturer	bbi-biotech GmbH
External Thread	Rd 28 × 1/8
Material Certificate	3.1, Rauigkeit, FDA
Country of Origin	DE 
HS-Code	73269098
Weight	0.2 kg
Material	Stainless steel 316L EPDM black

Components	1x adapter, 1x o-ring
Related Products	Adapter for 12 mm level and antifoam probes in M 26 × 1 ports (BBI-44630107) Adapter for 12 mm level and antifoam probes in Rd 28 × 1/8 ports (BBI-44630100) Adapter for 6 mm level probes or dip tubes for harvesting in Rd 28 × 1/8 ports (BBI-44630102)
<p>Description:</p> <ul style="list-style-type: none"> • For the installation of antifoam or level probes in the lid of a bioreactor • For probes with diameter 14 mm • Adapter without probe • For installation in Rd 28 × 1/8 ports 	



Alle / Verkaufsartikel / Accessories / Adapters / Clamp adapters

Adapter for 6 mm level probes or dip tubes for harvesting in Rd 28 × 1/8 ports



bbi Scancode	BBI-44630102
Manufacturer	bbi-biotech GmbH
External Thread	Rd 28 × 1/8
Material Certificate	3.1, Rauigkeit, FDA
Country of Origin	DE 
HS-Code	73269098
Weight	0.17 kg
Material	Stainless steel 316L EPDM black PTFE

Components	1x adapter; 1x clamping cone [BBI-44130017]; 1x coupling nut M 10 x 1 (high) [BBI-44130010]; 1x o-ring [BBI-45100013]; 1x o-ring [BBI-45100025]
Consumables	Clamping cone (Package of 5 pieces) (BBI-44130017) Coupling nut M 10 x 1 (high) (BBI-44130010) O-ring for items to install in Rd 28 x 1/8 ports (package of 10 pieces) (BBI-45100013) O-ring for adapter (package of 5 pieces) (BBI-45100025)
Related Products	Adapter for 12 mm level and antifoam probes in Rd 28 × 1/8 ports (BBI-44630100) Adapter for 6 mm level probes or dip tubes for harvesting in 11 mm ports (long) (BBI-44630104) Adapter for 6 mm level probes or dip tubes for harvesting in Pg 13.5 ports (BBI-44630106)

Description:

- For the installation of level probes or level probes or flexible harvest tubes in the lid of a bioreactor
- For probes/harvest tubes with diameter 6 mm
- For installation in Rd 28 × 1/8 ports
- Level probes and flexible harvest tubes are available separately in different lengths



To the Shop:



Alle / Verkaufsartikel / Accessories / Adapters / Clamp adapters

Adapter for 6 mm level probes or dip tubes for harvesting in 11 mm ports



bbi Scancode	BBI-44630103
Manufacturer	bbi-biotech GmbH
External Thread	M 10 x 1
Material Certificate	3.1, Rauigkeit, FDA
Country of Origin	DE 
HS-Code	73269098
Weight	0.03 kg
Material	Stainless steel 316L EPDM black PTFE

Components	1x adapter; 1x clamping cone [BBI-44130017]; 1x coupling nut M 10 x 1 (flat) [BBI-44130009]; coupling nut M 10 x 1 (high) [BBI-44130010]; 1x o-ring [BBI-45100011]; 1x o-ring [BBI-45100025]
Consumables	Clamping cone (Package of 5 pieces) (BBI-44130017) Coupling nut M 10 x 1 (flat) (BBI-44130009) Coupling nut M 10 x 1 (high) (BBI-44130010) O-ring for items to install in 11 mm ports (package of 10 pieces) (BBI-45100011) O-ring for adapter (package of 5 pieces) (BBI-45100025)
Related Products	Adapter for 12 mm level and antifoam probes in M 26 x 1 ports (BBI-44630107) Adapter for 6 mm level probes or dip tubes for harvesting in 11 mm ports (long) (BBI-44630104) Adapter for 6 mm level probes or dip tubes for harvesting in Pg 13.5 ports (BBI-44630106)

Description:

- For the installation of level probes or level probes or flexible harvest tubes in the lid of a bioreactor
- For probes/harvest tubes with diameter 6 mm
- For installation in 11 mm ports
- Level probes and flexible harvest tubes are available separately in different lengths



To the Shop:



Alle / Verkaufsartikel / Accessories / Adapters / Clamp adapters

Adapter for 6 mm level probes or dip tubes for harvesting in 11 mm ports (long)



bbi Scancode	BBI-44630104
Manufacturer	bbi-biotech GmbH
External Thread	M 10 x 1
Material Certificate	3.1, Rauigkeit, FDA
Country of Origin	DE 
HS-Code	73269098
Weight	0.03 kg
Material	Stainless steel 316L EPDM black PTFE

Components	1x adapter; 1x clamping cone [BBI-44130017]; 1x coupling nut M 10 x 1 (flat) [BBI-44130009]; coupling nut M 10 x 1 (high) [BBI-44130010]; 1x o-ring [BBI-45100011]; 1x o-ring [BBI-45100025]
Consumables	Clamping cone (Package of 5 pieces) (BBI-44130017) Coupling nut M 10 x 1 (flat) (BBI-44130009) Coupling nut M 10 x 1 (high) (BBI-44130010) O-ring for items to install in 11 mm ports (package of 10 pieces) (BBI-45100011) O-ring for adapter (package of 5 pieces) (BBI-45100025)
Related Products	Adapter for 12 mm probes in Pg 13.5 ports (BBI-44630105) Adapter for 6 mm level probes or dip tubes for harvesting in 11 mm ports (BBI-44630103) Adapter for 6 mm level probes or dip tubes for harvesting in Rd 28 x 1/8 ports (BBI-44630102)

Description:

- For the installation of antifoam or level probes or flexible harvest tubes in the lid
- For in-situ sterilizable bioreactors
- For probes/harvest tubes with diameter 6 mm
- Long version for 19.05 mm headplates



To the Shop:



Alle / Verkaufsartikel / Accessories / Adapters / Clamp adapters

Adapter for 12 mm probes in Pg 13.5 ports



bbi Scancode	BBI-44630105
Manufacturer	bbi-biotech GmbH
External Thread	Pg 13,5
Material Certificate	3.1, Rauigkeit, FDA
Country of Origin	DE 
HS-Code	73269098
Weight	0.06 kg
Material	Stainless steel 316L EPDM black

Components	1x adapter; 1x flat seal [BBI-44130214]; 1x o-ring; 1x security ring
Consumables	Flat seal with hole for 12 mm ports (package of 5 pieces) (BBI-44130214) Grub screw for Rushton stirrer for mounting on the stirrer shaft (package of 10 pieces) (BBI-45110502)
Related Products	Adapter for 12 mm level and antifoam probes in M 26 x 1 ports (BBI-44630107) Adapter for 6 mm level probes or dip tubes for harvesting in 11 mm ports (BBI-44630103) Adapter for 6 mm level probes or dip tubes for harvesting in Rd 28 x 1/8 ports (BBI-44630102)

Description:

- For the installation of probes in the lid of a bioreactor
- For probes with diameter 12 mm
- Adapter without probe



To the Shop:



Alle / Verkaufsartikel / Accessories / Adapters / Clamp adapters

Adapter for 6 mm level probes or dip tubes for harvesting in Pg 13.5 ports



bbi Scancode	BBI-44630106
Manufacturer	bbi-biotech GmbH
External Thread	Pg 13,5
Material Certificate	3.1, Rauigkeit, FDA
Country of Origin	DE 
HS-Code	73269098
Weight	0.06 kg
Material	Stainless steel 316L EPDM black PTFE

Components	1x adapter; 1x clamping cone [BBI-44130017]; 1x coupling nut M 10 x 1 (high) [BBI-44130010]; 1x o-ring [BBI-45100025]; 1x flat seal [BBI-44130214]
Consumables	Coupling nut M 10 x 1 (high) (BBI-44130010) Clamping cone (Package of 5 pieces) (BBI-44130017) Flat seal with hole for 12 mm ports (package of 5 pieces) (BBI-44130214) O-ring for adapter (package of 5 pieces) (BBI-45100025)
Related Products	Adapter for 12 mm level and antifoam probes in Rd 28 x 1/8 ports (BBI-44630100) Adapter for 12 mm probes in Pg 13.5 ports (BBI-44630105) Adapter for 6 mm level probes or dip tubes for harvesting in 11 mm ports (long) (BBI-44630104)

Description:

- For the installation of level probes or level probes or flexible harvest tubes in the lid of a bioreactor
- For probes/harvest tubes with diameter 6 mm
- For installation in Pg 13.5 ports
- Level probes and flexible harvest tubes are available separately in different lengths



To the Shop:



Alle / Verkaufsartikel / Accessories / Adapters / Clamp adapters

Adapter for 12 mm level and antifoam probes in M 26 x 1 ports



bbi Scancode	BBI-44630107
Manufacturer	bbi-biotech GmbH
External Thread	M 26 x 1
Material Certificate	3.1, Rauigkeit, FDA
Country of Origin	DE 
HS-Code	73269098
Weight	0.21 kg
Material	Stainless steel 316L EPDM black

Components	1x adapter; 2x O-rings
Related Products	<p>Adapter for 12 mm level and antifoam probes in Rd 28 x 1/8 ports (BBI-44630100)</p> <p>Adapter for 14 mm level and antifoam probes in Rd 28 x 1/8 ports (BBI-44630101)</p> <p>Adapter for 6 mm level probes or dip tubes for harvesting in 11 mm ports (long) (BBI-44630104)</p>
<p>Description:</p> <p>for 12 mm antifoam or level probes</p>	



To the Shop:



Alle / Verkaufsartikel / Accessories / Adapters / Probe adapters

Probe adapter 25 mm for G 1 ¼ (Ingold socket) for 12 mm probes



bbi Scancode	BBI-44130106
Manufacturer	bbi-biotech GmbH
Internal Thread	G 1 ¼, Pg 13,5
External Thread	M 27 x 2
Installation Depth	52 mm
Material Certificate	3.1, Rauigkeit
Country of Origin	DE 
HS-Code	73269098
Weight	0.54 kg
Material	Stainless steel 316L EPDM black

Components	1x probe adapter; 1x coupling nut with circlip [BBI-44130011]; 1x o-ring [BBI-45100014]; 1x o-ring [BBI-45100012]
Consumables	Circlips for items to install in 25 mm Ingold ports (package of 10 pieces) (BBI-45110301) O-ring for items to install in 25 mm Ingold ports (package of 10 pieces) (BBI-45100014) O-ring 12.37 x 2.62 (BBI-45100012)
Related Products	Blind plug 25 mm for G 1 ¼" (Ingold socket), standard length 52 mm (BBI-44130202) Probe adapter 25 mm for G 1 ¼" (Ingold socket) for 6.35 mm probes with 3/8" NPT external thread (BBI-44130116) Probe adapter 25 mm for G 1 ¼" (Ingold socket) with M 22 x 1 inner thread (BBI-44130114)

Description:

- Adapter to install long electrodes and probes with outside diameter of 12 mm in 25 mm ports of bioreactors / fermenters
- Complete with o-ring, nut and circlip
- For Ingold ports with length 52 mm / B. Braun Biotech 25 mm Safety Side ports
- Commonly used for in-situ systems



Alle / Verkaufsartikel / Accessories / Adapters / Probe adapters

Probe adapter 19/12 mm, Rd 28 x 1/8, Pg 13,5



bbi Scancode	BBI-44130107
Manufacturer	bbi-biotech GmbH
Internal Thread	Pg 13,5
External Thread	Rd 28 x 1/8
Material Certificate	3.1, Rauigkeit, FDA
Country of Origin	DE 
HS-Code	73269098
Weight	0.07 kg
Material	Stainless steel 316L EPDM black

Components	1x probe adapter; 1x o-ring [BBI-45100015]; 1x o-ring
Consumables	O-ring for items to install in M 26 x 1 ports (package of 10 pieces) (BBI-45100015)
Related Products	Blind plug Rd 28 x 1/8 (BBI-44130205) Probe adapter 19/12 mm, M 26 x 1, Pg 13,5 (BBI-44130108) Probe adapter 25 mm for G 1 1/4 (Ingold socket) for 12 mm probes (BBI-44130106)

Description:

- Adapter to install 12 mm-probes, electrodes, other components in 19 mm-ports
- Complete with o-ring
- Common with in-situ-sterilizable systems



To the Shop:



Alle / Verkaufsartikel / Accessories / Adapters / Probe adapters

Probe adapter 19/12 mm, M 26 x 1, Pg 13,5



bbi Scancode	BBI-44130108
Manufacturer	bbi-biotech GmbH
Internal Thread	Pg 13,5
External Thread	M 26 x 1
Material Certificate	3.1, Rauigkeit, FDA
Country of Origin	DE 
HS-Code	73269098
Weight	0.06 kg
Material	Stainless steel 316L EPDM black

Components	1x probe adapter; 1x o-ring [BBI-45100015]; 1x o-ring
Consumables	O-ring for items to install in M 26 x 1 ports (package of 10 pieces) (BBI-45100015)
Related Products	Blind plug for 19 mm ports M 26 x 1 (BBI-44130201) Probe adapter 19/12 mm, Rd 28 x 1/8, Pg 13,5 (BBI-44130107) Probe adapter 25 mm for G 1 1/4 (Ingold socket) for 12 mm probes (BBI-44130106)

Description:

- Adapter to install 12 mm-probes, electrodes, other components in 19 mm-ports
- Complete with o-ring
- Common with autoclavable systems



To the Shop:



Alle / Verkaufsartikel / Accessories / Adapters / Probe adapters

Probe adapter 25 mm for G 1 1/4" (Ingold socket) with M 22 x 1 inner thread



bbi Scancode	BBI-44130114
Manufacturer	bbi-biotech GmbH
Internal Thread	G 1 1/4, M 22 x 1
Installation Depth	52 mm
Material Certificate	3.1, Rauigkeit, FDA
Country of Origin	DE 
HS-Code	73269098
Material	Stainless steel 316L EPDM black

Components	1x probe adapter; 1x coupling nut with circlip [BBI-44130011]; 1x o-ring [BBI-45100014]; 1x o-ring
Consumables	Circlips for items to install in 25 mm Ingold ports (package of 10 pieces) (BBI-45110301) O-ring for items to install in 25 mm Ingold ports (package of 10 pieces) (BBI-45100014)
Related Products	Probe adapter 19/12 mm, Rd 28 x 1/8, Pg 13,5 (BBI-44130107) Probe adapter 25 mm for G 1 1/4" (Ingold socket) for 12 mm probes (BBI-44130106) Probe adapter 25 mm for G 1 1/4" (Ingold socket) for 6.35 mm probes with 3/8" NPT external thread (BBI-44130116)

Description:

- Adapter for M 22 x 1-threads in 25 mm ports of bioreactors / fermenters
- For Ingold ports with length 52 mm / B. Braun Biotech 25 mm Safety Side ports
- Internal thread M 22 x 1
- For 14 mm probes
- Spare part for fermenter or bioreactor



To the Shop:



Alle / Verkaufsartikel / Accessories / Adapters / Probe adapters

Probe adapter 25 mm for G 1 1/4" (Ingold socket) for 6.35 mm probes with 3/8" NPT external thread



bbi Scancode	BBI-44130116
Manufacturer	bbi-biotech GmbH
Internal Thread	3/8" NPT, G 1 1/4"
Installation Depth	52 mm
Material Certificate	3.1, Rauigkeit, FDA
Country of Origin	DE 
HS-Code	73269098
Material	Stainless steel 316L EPDM black

Components	1x probe adapter; 1x coupling nut with circlip [BBI-44130011]; 1x o-ring [BBI-45100014]; 1x o-ring [BBI-45100025]
Related Products	Blind plug 25 mm for G 1 1/4" (Ingold socket), standard length 52 mm (BBI-44130202) Probe adapter 25 mm for G 1 1/4" (Ingold socket) for 12 mm probes (BBI-44130106) Probe adapter 25 mm for G 1 1/4" (Ingold socket) with M 22 x 1 inner thread (BBI-44130114)

Description:

- Adapter to install long electrodes and probes with outside diameter of 6,35 mm in 25 mm ports of bioreactors / fermenters
- Complete with o-rings, nut and circlip
- For Ingold ports with length 52 mm / B. Braun Biotech 25 mm Safety Side ports
- Internal thread NPT 3/8"
- Spare part for fermenter or bioreactor



To the Shop:



Alle / Verkaufsartikel / Accessories / Adapters / Triclamp adapters

Triclamp adapter 34 with internal thread M 30 x 1



bbi Scancode	BBI-44130104
Manufacturer	bbi-biotech GmbH
Internal Thread	M 30 x 1
Material Certificate	3.1, Rauigkeit
Country of Origin	DE 
HS-Code	73269098
Material	Stainless steel 316L

Components	1x tri-clamp adaptor
Related Products	Exhaust air filter housing 5" with M 30 x 1 (BBI-43930501) Tri-clamp adaptor bypass for lid (BBI-44130109) Triclamp adapter M 30 x 1 with nut (BBI-44130105)
<p>Description:</p> <ul style="list-style-type: none"> • Adapter for connecting products with M 30 x 1 external thread to Triclamp 34 mm • Electropolished stainless steel 	



Alle / Verkaufsartikel / Accessories / Adapters / Triclamp adapters

Triclamp adapter M 30 x 1 with nut



bbi Scancode	BBI-44130105
Manufacturer	bbi-biotech GmbH
External Thread	M 30 x 1
Material Certificate	3.1, Rauigkeit
Country of Origin	DE 
HS-Code	73269098
Material	Stainless steel 316L

Components	1x tri-clamp adaptor; 1x nut
Related Products	M 30 x 1 socket with nuts (BBI-44730001) Triclamp adapter 34 with internal thread M 30 x 1 (BBI-44130104)
Description:	



To the Shop:



Alle / Verkaufsartikel / Accessories / Adapters / Triclamp adapters

Tri-clamp adaptor bypass for lid



bbi Scancode	BBI-44130109
Manufacturer	bbi-biotech GmbH
External Thread	Rd 28 x 1/8
Material Certificate	3.1, Rauigkeit, FDA
Country of Origin	DE 
HS-Code	73269098
Weight	0.18 kg
Material	Stainless steel 316L EPDM black

Components	1x tri-clamp adaptor; 1x o-ring [BBI-45100012]
Consumables	O-ring 12.37 x 2.62 (BBI-45100012)
Related Products	Gasket TC25 for hose connector exhaust cooler (package of 5 pieces) (BBI-45100302) O-ring 12.37 x 2.62 (BBI-45100012) Tri-clamp adaptor bypass for lid, Rd 28 x 1/8 13x1.5 (BBI-44130118)

Description:

- Accessory for autoclaving
- For the use with tri-clamp 25 mm fittings
- Adaptor Rd 28 x 1/8 to 25er tri-clamp for bypass in headplate
- Used for autoclaving addition ports, inoculation ports, exhaust cooler, etc with tri-clamp 25 mm



Alle / Verkaufsartikel / Accessories / Adapters / Triclamp adapters

Tri-clamp adaptor bypass for lid, Rd 28 x 1/8 13X1.5



bbi Scancode	BBI-44130118
Manufacturer	bbi-biotech GmbH
External Thread	Rd 28 x 1/8
Material Certificate	3.1, Rauigkeit, FDA
Country of Origin	DE 
Weight	0.18 kg
Material	Stainless steel 316L EPDM black

Components	1x tri-clamp adaptor; 1x o-ring [BBI-45100012]
Related Products	Gasket TC25 for hose connector exhaust cooler (package of 5 pieces) (BBI-45100302) O-ring 12.37 x 2.62 (BBI-45100012) Tri-clamp adaptor bypass for lid (BBI-44130109)

Description:

- Accessory for autoclaving
- For the use with tri-clamp 25 mm fittings
- Adaptor Rd 28 x 1/8 to 25er tri-clamp for bypass in headplate
- Used for autoclaving addition ports, inoculation ports, exhaust cooler, etc with tri-clamp 25 mm



To the Shop:



Alle / Verkaufsartikel / Accessories / Ventilation and Aeration

Gas supply nozzle 25 mm Ingold TC25 + 13 x 1.5



bbi Scancode	BBI-43530311
Manufacturer	bbi-biotech GmbH
Internal Thread	G 1 1/4
Material Certificate	3.1, Rauigkeit, FDA
Country of Origin	DE 
Weight	0.42 kg
Material	Stainless steel 316L EPDM black

Components	1x gas supply nozzle with coupling nut, 1x O-ring [BBI-45100014]
Related Products	Gas supply nozzle 25 mm Ingold TC25 + 10 x 1 (BBI-43530312)
Description:	



Alle / Verkaufsartikel / Accessories / Ventilation and Aeration

Gas supply nozzle 25 mm Ingold TC25 + 10 x 1



bbi Scancode	BBI-43530312
Manufacturer	bbi-biotech GmbH
Internal Thread	G 1 1/4
Material Certificate	3.1, Rauigkeit, FDA
Country of Origin	DE 
Weight	0.43 kg
Material	Stainless steel 316L EPDM black

Components	1x gas supply nozzle with coupling nut, 1x O-ring [BBI-45100014]
Related Products	Gas supply nozzle 25 mm Ingold TC25 + 13 x 1.5 (BBI-43530311)
Description:	



To the Shop:



Alle / Verkaufsartikel / Accessories / Ventilation and Aeration / Aeration baskets

1 L aeration basket



bbi Scancode	BBI-43530100
Manufacturer	bbi-biotech GmbH
External Thread	M 10 x 1
Material Certificate	3.1, Rauigkeit, FDA
Country of Origin	DE 
HS-Code	73269098
Weight	0.25 kg
Material	Stainless steel 316L EPDM black silicone

Components	1x aeration basket; 1x silicone tube [BBI-43530110]; 1x O-ring [BBI-45100011], 1x coupling nut M 10 x 1 (flat) [BBI-44130009]
Related Products	1 L Microsparger without frit (BBI-43530201) 1 L double-wall vessel, complete with accessories MO without sensors (BBI-44438010) Frit, M5, 2 µm (BBI-43530061)

Description:

- For bubble-free aeration of sensitive cultures in the bioreactor
- Particularly suitable for tissue cell cultures
- Diffusion via silicone membrane
- For aeration with air, O₂, N₂
- For pH-regulation with CO₂



To the Shop:



Alle / Verkaufsartikel / Accessories / Ventilation and Aeration / Aeration baskets

2 L aeration basket



bbi Scancode	BBI-43530101
Manufacturer	bbi-biotech GmbH
External Thread	M 10 x 1
Material Certificate	3.1, Rauigkeit, FDA
Country of Origin	DE 
HS-Code	73269098
Weight	0.35 kg
Material	Stainless steel 316L EPDM black silicone

Components	1x aeration basket; 1x silicone tube [BBI-43530110]; 1x O-ring [BBI-45100011], 1x coupling nut M 10 x 1 (flat) [BBI-44130009]
Consumables	Coupling nut M 10 x 1 (flat) (BBI-44130009) O-ring for items to install in 11 mm ports (package of 10 pieces) (BBI-45100011)
Related Products	2 L Microsparger without frit (BBI-43530202) 2 L ring sparger, upwards-facing holes with 0.8 mm (BBI-43530252) Tube for aeration basket, package of 10 m (BBI-43530110)

Description:

- For bubble-free aeration of sensitive cultures in the bioreactor
- Particularly suitable for tissue cell cultures
- Diffusion via silicone membrane
- For aeration with air, O₂, N₂
- For pH-regulation with CO₂



To the Shop:



Alle / Verkaufsartikel / Accessories / Ventilation and Aeration / Aeration baskets

5 L aeration basket



bbi Scancode	BBI-43530102
Manufacturer	bbi-biotech GmbH
External Thread	M 10 x 1
Material Certificate	3.1, Rauigkeit, FDA
Country of Origin	DE 
HS-Code	73269098
Material	Stainless steel 316L EPDM black silicone

Components	1x aeration basket; 1x silicone tube [BBI-43530110]
Related Products	0.5 L ring sparger, upwards-facing holes with 0.8 mm (BBI-43530250) 5 L jacketed glass vessel (BBI-44430034) Tube for aeration basket, package of 10 m (BBI-43530110)

Description:

- For bubble-free aeration of sensitive cultures in the bioreactor
- Particularly suitable for tissue cell cultures
- Diffusion via silicone membrane
- For aeration with air, O₂, N₂
- For pH-regulation with CO₂



Alle / Verkaufsartikel / Accessories / Ventilation and Aeration / Aeration baskets

10 L aeration basket



bbi Scancode	BBI-43530103
Manufacturer	bbi-biotech GmbH
External Thread	M 10 x 1
Material Certificate	3.1, Rauigkeit, FDA
Country of Origin	DE 
HS-Code	73269098
Material	Stainless steel 316L EPDM black silicone

Components

1x aeration basket; 1x silicone tube [BBI-43530110]

Description:

- For bubble-free aeration of sensitive cultures in the bioreactor
- Particularly suitable for tissue cell cultures
- Diffusion via silicone membrane
- For aeration with air, O₂, N₂
- For pH-regulation with CO₂



To the Shop:



Alle / Verkaufsartikel / Accessories / Ventilation and Aeration / Aeration baskets

20 L aeration basket



bbi Scancode	BBI-43530104
Manufacturer	bbi-biotech GmbH
External Thread	M 10 x 1
Material Certificate	3.1, Rauigkeit, FDA
Country of Origin	DE 
HS-Code	73269098
Material	Stainless steel 316L EPDM black silicone

Components	1x aeration basket; 1x silicone tube [BBI-43530110]
Related Products	20 L Pt100 casing (BBI-43430022) 20 L Rushton impeller (BBI-43230704) 20 L ring sparger, downwards-facing holes (BBI-43530093)

Description:

- For bubble-free aeration of sensitive cultures in the bioreactor
- Particularly suitable for tissue cell cultures
- Diffusion via silicone membrane
- For aeration with air, O₂, N₂
- For pH-regulation with CO₂



Alle / Verkaufsartikel / Accessories / Ventilation and Aeration / Aeration baskets

Tube for aeration basket, package of 10 m



bbi Scancode	BBI-43530110
Manufacturer	bbi-biotech GmbH
Material Certificate	FDA
Country of Origin	GB 
HS-Code	39173200
Material	silicone

Components	10 m silicone tube
Related Products	10 L aeration basket (BBI-43530103) 2 L aeration basket (BBI-43530101) 5 L aeration basket (BBI-43530102)
Description: <ul style="list-style-type: none"> • Spare part for aeration baskets • Silicone tube • ID = 2.3 mm; WS = 0.35 mm 	



To the Shop:



Alle / Verkaufsartikel / Accessories / Ventilation and Aeration / Aeration baskets

Pressure regulator for aeration baskets



bbi Scancode	BBI-43530111
Country of Origin	DE 
Weight	0.27 kg

Components	
Related Products	1 L aeration basket (BBI-43530100) 2 L aeration basket (BBI-43530101) 5 L aeration basket (BBI-43530102)
Description:	



To the Shop:



Alle / Verkaufsartikel / Accessories / Ventilation and Aeration / Frits

Frit, G 1/8, 20 µm



bbi Scancode	BBI-43530050
Manufacturer	bbi-biotech GmbH
External Thread	G 1/8
Country of Origin	DE 
HS-Code	84219990
Weight	0.01 kg
Material	Stainless steel 316L

Components	1x frit, 1x O-ring [BBI-45100025]
Consumables	O-ring for adapter (package of 5 pieces) (BBI-45100025)
Related Products	Frit, G1/8, 100 µm (BBI-43530075) Frit, G1/8, 120 µm (BBI-43530076) Frit, G1/8, 40 µm (BBI-43530073)

Description:

- Spare part for micro sparger
- Frit made of sintered stainless steel
- Thread: G 1/8
- Pore size: 20 µm
- Total length (with thread) = 31 mm
- Ø 10 mm



To the Shop:



Alle / Verkaufsartikel / Accessories / Ventilation and Aeration / Frits

Frit, M5, 2 µm



bbi Scancode	BBI-43530061
Manufacturer	bbi-biotech GmbH
External Thread	M 5
Country of Origin	JP 
HS-Code	84219990
Weight	0.01 kg
Material	Stainless steel 316L

Components	1x frit, 1x O-ring [BBI-45100029]
Related Products	Frit, M5, 10 µm (BBI-43530063) Frit, M5, 20 µm (BBI-43530064) Frit, M5, 5 µm (BBI-43530062)

Description:

- Spare part for micro sparger
- Frit made of sintered stainless steel
- Thread: M 5
- Pore size: 2 µm
- Total length (with thread) = 17 mm
- Ø 8 mm



To the Shop:



Alle / Verkaufsartikel / Accessories / Ventilation and Aeration / Frits

Frit, M5, 5 µm



bbi Scancode	BBI-43530062
Manufacturer	bbi-biotech GmbH
External Thread	M 5
Country of Origin	JP 
HS-Code	84219990
Weight	0.01 kg
Material	Stainless steel 316L

Components	1x frit, 1x O-ring [BBI-45100029]
Related Products	Frit, M5, 10 µm (BBI-43530063) Frit, M5, 20 µm (BBI-43530064) Frit, M5, 40 µm (BBI-43530065)
Description: <ul style="list-style-type: none"> • Spare part for micro sparger • Frit made of sintered stainless steel • Thread: M 5 • Pore size: 5 µm • Total length (with thread) = 17 mm • Ø 8 mm 	



To the Shop:



Alle / Verkaufsartikel / Accessories / Ventilation and Aeration / Frits

Frit, M5, 10 µm



bbi Scancode	BBI-43530063
Manufacturer	bbi-biotech GmbH
External Thread	M 5
Country of Origin	JP 
HS-Code	84219990
Weight	0.01 kg
Material	Stainless steel 316L

Components	1x frit, 1x O-ring [BBI-45100029]
Related Products	Frit, M5, 2 µm (BBI-43530061) Frit, M5, 20 µm (BBI-43530064) Frit, M5, 40 µm (BBI-43530065)

Description:

- Spare part for micro sparger
- Frit made of sintered stainless steel
- Thread: M 5
- Pore size: 10 µm
- Total length (with thread) = 17 mm
- Ø 8 mm



To the Shop:



Alle / Verkaufsartikel / Accessories / Ventilation and Aeration / Frits

Frit, M5, 20 µm



bbi Scancode	BBI-43530064
Manufacturer	bbi-biotech GmbH
External Thread	M 5
Country of Origin	JP 
HS-Code	84219990
Weight	0.01 kg
Material	Stainless steel 316L

Components	1x frit, 1x O-ring [BBI-45100029]
Related Products	Frit, M5, 10 µm (BBI-43530063) Frit, M5, 40 µm (BBI-43530065) Frit, M5, 5 µm (BBI-43530062)

Description:

- Spare part for micro sparger
- Frit made of sintered stainless steel
- Thread: M 5
- Pore size: 20 µm
- Total length (with thread) = 17 mm
- Ø 8 mm



To the Shop:



Alle / Verkaufsartikel / Accessories / Ventilation and Aeration / Frits

Frit, M5, 40 µm



bbi Scancode	BBI-43530065
Manufacturer	bbi-biotech GmbH
External Thread	M 5
Country of Origin	JP 
HS-Code	84219990
Weight	0.01 kg
Material	Stainless steel 316L

Components	1x frit, 1x O-ring [BBI-45100029]
Related Products	Frit, M5, 100 µm (BBI-43530067) Frit, M5, 120 µm (BBI-43530068) Frit, M5, 20 µm (BBI-43530064)
Description: <ul style="list-style-type: none"> • Spare part for micro sparger • Frit made of sintered stainless steel • Thread: M 5 • Pore size: 40 µm • Total length (with thread) = 17 mm • Ø 8 mm 	



To the Shop:



Alle / Verkaufsartikel / Accessories / Ventilation and Aeration / Frits

Frit, M5, 70 µm



bbi Scancode	BBI-43530066
Manufacturer	bbi-biotech GmbH
External Thread	M 5
Country of Origin	JP 
HS-Code	84219990
Weight	0.01 kg
Material	Stainless steel 316L

Components	1x frit, 1x O-ring [BBI-45100029]
Related Products	Frit, M5, 100 µm (BBI-43530067) Frit, M5, 120 µm (BBI-43530068) Frit, M5, 40 µm (BBI-43530065)

Description:

- Spare part for micro sparger
- Frit made of sintered stainless steel
- Thread: M 5
- Pore size: 70 µm
- Total length (with thread) = 17 mm
- Ø 8 mm



To the Shop:



Alle / Verkaufsartikel / Accessories / Ventilation and Aeration / Frits

Frit, M5, 100 µm



bbi Scancode	BBI-43530067
Manufacturer	bbi-biotech GmbH
External Thread	M 5
Country of Origin	JP 
HS-Code	84219990
Weight	0.01 kg
Material	Stainless steel 316L

Components	1x frit, 1x O-ring [BBI-45100029]
Related Products	Frit, M5, 120 µm (BBI-43530068) Frit, M5, 2 µm (BBI-43530061) Frit, M5, 40 µm (BBI-43530065)

Description:

- Spare part for micro sparger
- Frit made of sintered stainless steel
- Thread: M 5
- Pore size: 100 µm
- Total length (with thread) = 17 mm
- Ø 8 mm



To the Shop:



Alle / Verkaufsartikel / Accessories / Ventilation and Aeration / Frits

Frit, M5, 120 µm



bbi Scancode	BBI-43530068
Manufacturer	bbi-biotech GmbH
External Thread	M 5
Country of Origin	JP 
HS-Code	84219990
Weight	0.01 kg
Material	Stainless steel 316L

Components	1x frit, 1x O-ring [BBI-45100029]
Related Products	Frit, M5, 100 µm (BBI-43530067) Frit, M5, 40 µm (BBI-43530065) Frit, M5, 70 µm (BBI-43530066)
Description: <ul style="list-style-type: none"> • Spare part for micro sparger • Frit made of sintered stainless steel • Thread: M 5 • Pore size: 120 µm • Total length (with thread) = 17 mm • Ø 8 mm 	



To the Shop:



Alle / Verkaufsartikel / Accessories / Ventilation and Aeration / Frits

Frit, G 1/8, 2 µm



bbi Scancode	BBI-43530069
Manufacturer	bbi-biotech GmbH
External Thread	G 1/8
Country of Origin	JP 
HS-Code	84219990
Weight	0.02 kg
Material	Stainless steel 316L

Components	1x frit, 1x O-ring [BBI-45100025]
Related Products	Frit, G1/8, 40 µm (BBI-43530073) Frit, G1/8, 5 µm (BBI-43530070) Frit, G1/8, 70 µm (BBI-43530074)

Description:

- Spare part for micro sparger
- Frit made of sintered stainless steel
- Thread: G 1/8
- Pore size: 2 µm
- Total length (with thread) = 38 mm
- Ø 13 mm



To the Shop:



Alle / Verkaufsartikel / Accessories / Ventilation and Aeration / Frits

Frit, G1/8, 5 µm



bbi Scancode	BBI-43530070
Manufacturer	bbi-biotech GmbH
External Thread	G 1/8
Country of Origin	JP 
HS-Code	84219990
Weight	0.02 kg
Material	Stainless steel 316L

Components	1x frit, 1x O-ring [BBI-45100025]
Related Products	Frit, G 1/8, 2 µm (BBI-43530069) Frit, G1/8, 10 µm (BBI-43530071) Frit, G1/8, 40 µm (BBI-43530073)

Description:

- Spare part for micro sparger
- Frit made of sintered stainless steel
- Thread: G 1/8
- Pore size: 5 µm
- Total length (with thread) = 38 mm
- Ø 13 mm



To the Shop:



Alle / Verkaufsartikel / Accessories / Ventilation and Aeration / Frits

Frit, G1/8, 10 µm



bbi Scancode	BBI-43530071
Manufacturer	bbi-biotech GmbH
External Thread	G 1/8
Country of Origin	JP 
HS-Code	84219990
Weight	0.02 kg
Material	Stainless steel 316L

Components	1x frit, 1x O-ring [BBI-45100025]
Related Products	Frit, G 1/8, 20 µm (BBI-43530050) Frit, G1/8, 100 µm (BBI-43530075) Frit, G1/8, 40 µm (BBI-43530073)
<p>Description:</p> <ul style="list-style-type: none"> • Spare part for micro sparger • Frit made of sintered stainless steel • Thread: G 1/8 • Pore size: 10 µm • Total length (with thread) = 38 mm • Ø 13 mm 	



To the Shop:



Alle / Verkaufsartikel / Accessories / Ventilation and Aeration / Frits

Frit, G1/8, 20 µm



bbi Scancode	BBI-43530072
Manufacturer	bbi-biotech GmbH
External Thread	G 1/8
Country of Origin	JP 
HS-Code	84219990
Weight	0.02 kg
Material	Stainless steel 316L

Components	1x frit, 1x O-ring [BBI-45100025]
Related Products	Frit, G1/8, 10 µm (BBI-43530071) Frit, G1/8, 40 µm (BBI-43530073) Frit, G1/8, 70 µm (BBI-43530074)

Description:

- Spare part for micro sparger
- Frit made of sintered stainless steel
- Thread: G 1/8
- Pore size: 20 µm
- Total length (with thread) = 38 mm
- Ø 13 mm



To the Shop:



Alle / Verkaufsartikel / Accessories / Ventilation and Aeration / Frits

Frit, G1/8, 40 µm



bbi Scancode	BBI-43530073
Manufacturer	bbi-biotech GmbH
External Thread	G 1/8
Country of Origin	JP 
HS-Code	84219990
Weight	0.02 kg
Material	Stainless steel 316L

Components	1x frit, 1x O-ring [BBI-45100025]
Related Products	Frit, G1/8, 10 µm (BBI-43530071) Frit, G1/8, 100 µm (BBI-43530075) Frit, G1/8, 70 µm (BBI-43530074)

Description:

- Spare part for micro sparger
- Frit made of sintered stainless steel
- Thread: G 1/8
- Pore size: 40 µm
- Total length (with thread) = 38 mm
- Ø 13 mm



To the Shop:



Alle / Verkaufsartikel / Accessories / Ventilation and Aeration / Frits

Frit, G1/8, 70 µm



bbi Scancode	BBI-43530074
Manufacturer	bbi-biotech GmbH
External Thread	G 1/8
Country of Origin	JP 
HS-Code	84219990
Weight	0.02 kg
Material	Stainless steel 316L

Components	1x frit, 1x O-ring [BBI-45100025]
Related Products	Frit, G1/8, 100 µm (BBI-43530075) Frit, G1/8, 120 µm (BBI-43530076) Frit, G1/8, 5 µm (BBI-43530070)
Description: <ul style="list-style-type: none"> • Spare part for micro sparger • Frit made of sintered stainless steel • Thread: G 1/8 • Pore size: 70 µm • Total length (with thread) = 38 mm • Ø 13 mm 	



To the Shop:



Alle / Verkaufsartikel / Accessories / Ventilation and Aeration / Frits

Frit, G1/8, 100 µm



bbi Scancode	BBI-43530075
Manufacturer	bbi-biotech GmbH
External Thread	G 1/8
Country of Origin	JP 
HS-Code	84219990
Weight	0.02 kg
Material	Stainless steel 316L

Components	1x frit, 1x O-ring [BBI-45100025]
Related Products	<p>Frit, G 1/8, 20 µm (BBI-43530050)</p> <p>Frit, G1/8, 10 µm (BBI-43530071)</p> <p>Frit, G1/8, 40 µm (BBI-43530073)</p>
<p>Description:</p> <ul style="list-style-type: none"> • Spare part for micro sparger • Frit made of sintered stainless steel • Thread: G 1/8 • Pore size: 100 µm • Total length (with thread) = 38 mm • Ø 13 mm 	



To the Shop:



Alle / Verkaufsartikel / Accessories / Ventilation and Aeration / Frits

Frit, G1/8, 120 µm



bbi Scancode	BBI-43530076
Manufacturer	bbi-biotech GmbH
External Thread	G 1/8
Country of Origin	JP 
HS-Code	84219990
Weight	0.02 kg
Material	Stainless steel 316L

Components	1x frit, 1x O-ring [BBI-45100025]
Related Products	Frit, G1/8, 100 µm (BBI-43530075) Frit, G1/8, 40 µm (BBI-43530073) Frit, G1/8, 70 µm (BBI-43530074)
Description: <ul style="list-style-type: none"> • Spare part for micro sparger • Frit made of sintered stainless steel • Thread: G 1/8 • Pore size: 120 µm • Total length (with thread) = 38 mm • Ø 13 mm 	



To the Shop:



Alle / Verkaufsartikel / Accessories / Ventilation and Aeration / L-Spargers

0,25 L L-Sparger, holes upwards



bbi Scancode	BBI-43530220
Manufacturer	bbi-biotech GmbH
External Thread	M 10 x 1
Installation Depth	124 mm
Material Certificate	3.1, Rauigkeit, FDA
Country of Origin	DE 
HS-Code	73269098
Weight	0.04 kg
Material	Stainless steel 316L EPDM black

Components	1x L-sparger, 1x O-ring [BBI-45100011], 1x coupling nut M 10 x 1 (flat) [BBI-44130009]
Consumables	Coupling nut M 10 x 1 (flat) (BBI-44130009) O-ring for items to install in 11 mm ports (package of 10 pieces) (BBI-45100011)
Related Products	0,25 L L-Sparger, holes downwards (BBI-43530228) 0.25 L Microsparger without frit (BBI-43530205) 0.25 L jacketed glass vessel (BBI-44430054)

Description:

- For gassing of culture media
- L-sparger with upward facing holes
- Holes: Ø 0.5 mm



To the Shop:



Alle / Verkaufsartikel / Accessories / Ventilation and Aeration / L-Spargers

0,50 L L-Sparger, holes upwards



bbi Scancode	BBI-43530221
Manufacturer	bbi-biotech GmbH
External Thread	M 10 x 1
Material Certificate	3.1, Rauigkeit, FDA
Country of Origin	DE 
HS-Code	73269098
Material	Stainless steel 316L EPDM black

Components	1x L-sparger, 1x O-ring [BBI-45100011], 1x coupling nut M 10 x 1 (flat) [BBI-44130009]
Consumables	Coupling nut M 10 x 1 (flat) (BBI-44130009) O-ring for items to install in 11 mm ports (package of 10 pieces) (BBI-45100011)
Related Products	0,25 L L-Sparger, holes upwards (BBI-43530220) 0.25 L Microsparger without frit (BBI-43530205) 0.5 L ring sparger, downwards-facing holes with 0.5 mm (BBI-43530087)

Description:

- For gassing of culture media
- L-sparger with upward facing holes
- Holes: Ø 0.5 mm



Alle / Verkaufsartikel / Accessories / Ventilation and Aeration / L-Spargers

1 L L-Sparger, holes upwards



bbi Scancode	BBI-43530222
Manufacturer	bbi-biotech GmbH
External Thread	M 10 x 1
Material Certificate	3.1, Rauigkeit, FDA
Country of Origin	DE 
HS-Code	73269098
Material	Stainless steel 316L EPDM black

Components

1x L-sparger, 1x O-ring [BBI-45100011], 1x coupling nut M 10 x 1 (flat) [BBI-44130009]

Description:

- For gassing of culture media
- L-sparger with upward facing holes
- Holes: Ø 0.5 mm



To the Shop:



Alle / Verkaufsartikel / Accessories / Ventilation and Aeration / L-Spargers

2 L L-Sparger, holes upwards



bbi Scancode	BBI-43530223
Manufacturer	bbi-biotech GmbH
External Thread	M 10 x 1
Material Certificate	3.1, Rauigkeit, FDA
Country of Origin	DE 
HS-Code	73269098
Material	Stainless steel 316L EPDM black

Components	1x L-sparger, 1x O-ring [BBI-45100011], 1x coupling nut M 10 x 1 (flat) [BBI-44130009]
Consumables	Coupling nut M 10 x 1 (flat) (BBI-44130009) O-ring for items to install in 11 mm ports (package of 10 pieces) (BBI-45100011)
Related Products	2 L L-Sparger, holes downwards (BBI-43530231) 2 L Microsparger without frit (BBI-43530202) 2 L ring sparger, upwards-facing holes with 0.8 mm (BBI-43530252)
Description: <ul style="list-style-type: none"> • For gassing of culture media • L-sparger with upward facing holes • Holes: Ø 0.5 mm 	



Alle / Verkaufsartikel / Accessories / Ventilation and Aeration / L-Spargers

5 L L-Sparger, holes upwards



bbi Scancode	BBI-43530224
Manufacturer	bbi-biotech GmbH
External Thread	M 10 x 1
Material Certificate	3.1, Rauigkeit, FDA
Country of Origin	DE 
HS-Code	73269098
Material	Stainless steel 316L EPDM black

Components	1x L-sparger, 1x O-ring [BBI-45100011], 1x coupling nut M 10 x 1 (flat) [BBI-44130009]
Consumables	Coupling nut M 10 x 1 (flat) (BBI-44130009) O-ring for items to install in 11 mm ports (package of 10 pieces) (BBI-45100011)
Related Products	5 L L-Sparger, holes downwards (BBI-43530232) 5 L Microsparger without frit (BBI-43530203) 5 L ring sparger, upwards-facing holes with 0.8 mm (BBI-43530253)
Description: <ul style="list-style-type: none"> • For gassing of culture media • L-sparger with upward facing holes • Holes: Ø 0.5 mm 	



Alle / Verkaufsartikel / Accessories / Ventilation and Aeration / L-Spargers

10 L L-Sparger, holes upwards



bbi Scancode	BBI-43530225
Manufacturer	bbi-biotech GmbH
External Thread	M 10 x 1
Material Certificate	3.1, Rauigkeit, FDA
Country of Origin	DE 
HS-Code	73269098
Material	Stainless steel 316L EPDM black

Components	1x L-sparger, 1x O-ring [BBI-45100011], 1x coupling nut M 10 x 1 (flat) [BBI-44130009]
Consumables	Coupling nut M 10 x 1 (flat) (BBI-44130009) O-ring for items to install in 11 mm ports (package of 10 pieces) (BBI-45100011)
Related Products	10 L L-Sparger, holes downwards (BBI-43530233) 10 L dip tube for harvesting, fix, ID = 4 mm, M 10 x 1 (BBI-43630014) 10 L ring sparger, upwards-facing holes with 0.8 mm (BBI-43530254)
Description: <ul style="list-style-type: none"> • For gassing of culture media • L-sparger with upward facing holes • Holes: Ø 0.5 mm 	



Alle / Verkaufsartikel / Accessories / Ventilation and Aeration / L-Spargers

0,25 L L-Sparger, holes downwards



bbi Scancode	BBI-43530228
Manufacturer	bbi-biotech GmbH
External Thread	M 10 x 1
Installation Depth	124 mm
Material Certificate	3.1, Rauigkeit, FDA
Country of Origin	DE 
HS-Code	73269098
Material	Stainless steel 316L EPDM black

Components	1x L-sparger, 1x O-ring [BBI-45100011], 1x coupling nut M 10 x 1 (flat) [BBI-44130009]
Consumables	Coupling nut M 10 x 1 (flat) (BBI-44130009) O-ring for items to install in 11 mm ports (package of 10 pieces) (BBI-45100011)
Related Products	0,25 L L-Sparger, holes upwards (BBI-43530220) 0.25 L Microsparger without frit (BBI-43530205) 0.25 L single-walled glass vessel (BBI-44430299)

Description:

- For gassing of culture media
- L-sparger with downward facing holes
- Holes: Ø 0.5 mm



To the Shop:



Alle / Verkaufsartikel / Accessories / Ventilation and Aeration / L-Spargers

0,50 L L-Sparger, holes downwards



bbi Scancode	BBI-43530229
Manufacturer	bbi-biotech GmbH
External Thread	M 10 x 1
Material Certificate	3.1, Rauigkeit, FDA
Country of Origin	DE 
HS-Code	73269098
Material	Stainless steel 316L EPDM black

Components	1x L-sparger, 1x O-ring [BBI-45100011], 1x coupling nut M 10 x 1 (flat) [BBI-44130009]
Consumables	Coupling nut M 10 x 1 (flat) (BBI-44130009) O-ring for items to install in 11 mm ports (package of 10 pieces) (BBI-45100011)
Related Products	0,50 L L-Sparger, holes upwards (BBI-43530221) 0.5 L Microsparger without frit (BBI-43530200) 0.5 L jacketed glass vessel (BBI-44430004)

Description:

- For gassing of culture media
- L-sparger with downward facing holes
- Holes: Ø 0.5 mm



To the Shop:



Alle / Verkaufsartikel / Accessories / Ventilation and Aeration / L-Spargers

1 L L-Sparger, holes downwards



bbi Scancode	BBI-43530230
Manufacturer	bbi-biotech GmbH
External Thread	M 10 x 1
Material Certificate	3.1, Rauigkeit, FDA
Country of Origin	DE 
HS-Code	73269098
Material	Stainless steel 316L EPDM black

Components	1x L-sparger, 1x O-ring [BBI-45100011], 1x coupling nut M 10 x 1 (flat) [BBI-44130009]
Consumables	Coupling nut M 10 x 1 (flat) (BBI-44130009) O-ring for items to install in 11 mm ports (package of 10 pieces) (BBI-45100011)
<p>Description:</p> <ul style="list-style-type: none"> • For gassing of culture media • L-sparger with downward facing holes • Holes: Ø 0.5 mm 	



Alle / Verkaufsartikel / Accessories / Ventilation and Aeration / L-Spargers

2 L L-Sparger, holes downwards



bbi Scancode	BBI-43530231
Manufacturer	bbi-biotech GmbH
External Thread	M 10 x 1
Material Certificate	3.1, Rauigkeit, FDA
Country of Origin	DE 
HS-Code	73269098
Material	Stainless steel 316L EPDM black

Components	1x L-sparger, 1x O-ring [BBI-45100011], 1x coupling nut M 10 x 1 (flat) [BBI-44130009]
Consumables	Coupling nut M 10 x 1 (flat) (BBI-44130009) O-ring for items to install in 11 mm ports (package of 10 pieces) (BBI-45100011)
Related Products	2 L L-Sparger, holes upwards (BBI-43530223) 2 L Microsparger without frit (BBI-43530202) 2 L ring sparger, upwards-facing holes with 0.8 mm (BBI-43530252)

Description:

- For gassing of culture media
- L-sparger with downward facing holes
- Holes: Ø 0.5 mm



Alle / Verkaufsartikel / Accessories / Ventilation and Aeration / L-Spargers

5 L L-Sparger, holes downwards



bbi Scancode	BBI-43530232
Manufacturer	bbi-biotech GmbH
External Thread	M 10 x 1
Material Certificate	3.1, Rauigkeit, FDA
Country of Origin	DE 
HS-Code	73269098
Material	Stainless steel 316L EPDM black

Components	1x L-sparger, 1x O-ring [BBI-45100011], 1x coupling nut M 10 x 1 (flat) [BBI-44130009]
Consumables	Coupling nut M 10 x 1 (flat) (BBI-44130009) O-ring for items to install in 11 mm ports (package of 10 pieces) (BBI-45100011)
Related Products	5 L L-Sparger, holes upwards (BBI-43530224) 5 L Microsparger without frit (BBI-43530203) 5 L ring sparger, downwards-facing holes with 0.8 mm (BBI-43530259)
Description: <ul style="list-style-type: none"> • For gassing of culture media • L-sparger with downward facing holes • Holes: Ø 0.5 mm 	



Alle / Verkaufsartikel / Accessories / Ventilation and Aeration / L-Spargers

10 L L-Sparger, holes downwards



bbi Scancode	BBI-43530233
Manufacturer	bbi-biotech GmbH
External Thread	M 10 x 1
Material Certificate	3.1, Rauigkeit, FDA
Country of Origin	DE 
HS-Code	73269098
Material	Stainless steel 316L EPDM black

Components	1x L-sparger, 1x O-ring [BBI-45100011], 1x coupling nut M 10 x 1 (flat) [BBI-44130009]
Consumables	Coupling nut M 10 x 1 (flat) (BBI-44130009) O-ring for items to install in 11 mm ports (package of 10 pieces) (BBI-45100011)
Related Products	10 L L-Sparger, holes upwards (BBI-43530225) 10 L dip tube for harvesting, fix, ID = 4 mm, M 10 x 1 (BBI-43630014) 10 L ring sparger with chicane, downwards-facing holes with 0.8 mm (BBI-43530266)

Description:

- For gassing of culture media
- L-sparger with downward facing holes
- Holes: Ø 0.5 mm



Alle / Verkaufsartikel / Accessories / Ventilation and Aeration / Draft tubes

1 L draft tube



bbi Scancode	BBI-43530502
Manufacturer	bbi-biotech GmbH
External Thread	M 10 x 1
Material Certificate	3.1, Rauigkeit, FDA
Country of Origin	DE 
Material	Stainless steel 316L EPDM black

Components	1x draft tube, 1x o-ring [BBI-45100011], 1x coupling nut M 10 x 1 (flat) [BBI-44130009]
------------	---

Description:

- Installation in the culture vessel instead of a baffle basket
- For a vertical flow around the medium in the culture vessel
- Used together with a segment blade stirrer
- Spare part for bioreactors



To the Shop:



Alle / Verkaufsartikel / Accessories / Ventilation and Aeration / Draft tubes

2 L draft tube



bbi Scancode	BBI-43530503
Manufacturer	bbi-biotech GmbH
External Thread	M 10 x 1
Material Certificate	3.1, Rauigkeit, FDA
Country of Origin	DE 
Material	Stainless steel 316L EPDM black

Components	1x draft tube, 1x o-ring [BBI-45100011], 1x coupling nut M 10 x 1 (flat) [BBI-44130009]
Related Products	2 L 3-bladed-segment impeller (BBI-43230304) 2 L baffle (BBI-43230032) 5 L draft tube (BBI-43530504)
<p>Description:</p> <ul style="list-style-type: none"> • Installation in the culture vessel instead of a baffle basket • For a vertical flow around the medium in the culture vessel • Used together with a segment blade stirrer • Spare part for bioreactors 	



Alle / Verkaufsartikel / Accessories / Ventilation and Aeration / Draft tubes

5 L draft tube



bbi Scancode	BBI-43530504
Manufacturer	bbi-biotech GmbH
External Thread	M 10 x 1
Material Certificate	3.1, Rauigkeit, FDA
Country of Origin	DE 
Material	Stainless steel 316L EPDM black

Components	1x draft tube, 2x o-ring [BBI-45100011], 2x coupling nut M 10 x 1 (flat) [BBI-44130009]
Related Products	2 L draft tube (BBI-43530503) 5 L Microsparger without frit (BBI-43530203) 5 L baffle (BBI-43230033)
<p>Description:</p> <ul style="list-style-type: none"> • Installation in the culture vessel instead of a baffle basket • For a vertical flow around the medium in the culture vessel • Used together with a segment blade stirrer • Spare part for bioreactors 	



Alle / Verkaufsartikel / Accessories / Ventilation and Aeration / Draft tubes

10 L draft tube



bbi Scancode	BBI-43530505
Manufacturer	bbi-biotech GmbH
External Thread	M 10 x 1
Material Certificate	3.1, Rauigkeit, FDA
Material	Stainless steel 316L EPDM black

Components	1x draft tube, 2x o-ring [BBI-45100011], 2x coupling nut M 10 x 1 (flat) [BBI-44130009]
Related Products	1 L draft tube (BBI-43530502) 2 L draft tube (BBI-43530503) 5 L draft tube (BBI-43530504)
Description: <ul style="list-style-type: none"> • Installation in the culture vessel instead of a baffle basket • For a vertical flow around the medium in the culture vessel • Used together with a segment blade stirrer • Spare part for bioreactors 	



To the Shop:



Alle / Verkaufsartikel / Accessories / Ventilation and Aeration / Microspargers

Microsparger with frit 20 µm, l = 480 mm, M 10 x 1



bbi Scancode	BBI-43530006
Manufacturer	bbi-biotech GmbH
External Thread	M 10 x 1
Installation Depth	447 mm
Material Certificate	3.1, Rauigkeit, FDA
Country of Origin	DE 
HS-Code	73269098
Material	Stainless steel 316L EPDM black

Components	1x microsparger with G 1/8, 1x O-ring [BBI-45100011], 1x coupling nut M 10 x 1 (flat) [BBI-44130009]; 1x frit [BBI-43530050]
Consumables	O-ring for items to install in 11 mm ports (package of 10 pieces) (BBI-45100011)
Related Products	10 L Microsparger without frit (BBI-43530204) 10 L ring sparger with chicane, upwards-facing holes with 0.8 mm (BBI-43530272) Frit, G1/8, 40 µm (BBI-43530073)

Description:

- For the aeration and supply with other gasses of a bioreactor
- For shear-sensitive culture
- Aeration with very fine bubbles
- For air, O₂, N₂, CO₂
- Total length = 480 mm
- Spare part for bioreactors



To the Shop:



Alle / Verkaufsartikel / Accessories / Ventilation and Aeration / Microspargers

0.5 L Microsparger without frit



bbi Scancode	BBI-43530200
Manufacturer	bbi-biotech GmbH
Internal Thread	M 5
External Thread	M 10 x 1
Installation Depth	136 mm
Material Certificate	3.1, Rauigkeit, FDA
Country of Origin	DE 
HS-Code	73269098
Weight	0.04 kg
Material	Stainless steel 316L EPDM black

Components	1x microsparger with M 5, 1x O-ring [BBI-45100011], 1x coupling nut M 10 x 1 (flat) [BBI-44130009]
Consumables	Coupling nut M 10 x 1 (flat) (BBI-44130009) O-ring for items to install in 11 mm ports (package of 10 pieces) (BBI-45100011)
Related Products	0,50 L L-Sparger, holes upwards (BBI-43530221) Frit, M5, 20 µm (BBI-43530064) Frit, M5, 40 µm (BBI-43530065)

Description:

- For the aeration and supply with other gasses of a bioreactor
- For shear-sensitive culture
- Aeration with very fine bubbles
- For air, O₂, N₂, CO₂
- Frit with needed pore size available separately



Alle / Verkaufsartikel / Accessories / Ventilation and Aeration / Microspargers

1 L Microsparger without frit



bbi Scancode	BBI-43530201
Manufacturer	bbi-biotech GmbH
Internal Thread	M 5
External Thread	M 10 x 1
Installation Depth	172 mm
Material Certificate	3.1, Rauigkeit, FDA
Country of Origin	DE 
HS-Code	73269098
Weight	0.05 kg
Material	Stainless steel 316L EPDM black

Components	1x microsparger with M 5, 1x O-ring [BBI-45100011], 1x coupling nut M 10 x 1 (flat) [BBI-44130009]
Consumables	Coupling nut M 10 x 1 (flat) (BBI-44130009) O-ring for items to install in 11 mm ports (package of 10 pieces) (BBI-45100011)
Related Products	1 L L-Sparger, holes upwards (BBI-43530222) 1 L ring sparger, upwards-facing holes with 0.8 mm (BBI-43530251) Frit, M5, 20 µm (BBI-43530064)

Description:

- For the aeration and supply with other gasses of a bioreactor
- For shear-sensitive culture
- Aeration with very fine bubbles
- For air, O₂, N₂, CO₂
- Frit with needed pore size available separately



To the Shop:



Alle / Verkaufsartikel / Accessories / Ventilation and Aeration / Microspargers

2 L Microsparger without frit



bbi Scancode	BBI-43530202
Manufacturer	bbi-biotech GmbH
Internal Thread	G 1/8
External Thread	M 10 x 1
Installation Depth	245 mm
Material Certificate	3.1, Rauigkeit, FDA
Country of Origin	DE 
HS-Code	73269098
Weight	0.06 kg
Material	Stainless steel 316L EPDM black

Components	1x microsparger with G 1/8, 1x O-ring [BBI-45100011], 1x coupling nut M 10 x 1 (flat) [BBI-44130009]
Consumables	Coupling nut M 10 x 1 (flat) (BBI-44130009) O-ring for items to install in 11 mm ports (package of 10 pieces) (BBI-45100011)
Related Products	2 L L-Sparger, holes upwards (BBI-43530223) 2 L ring sparger, upwards-facing holes with 0.8 mm (BBI-43530252) Frit, G1/8, 40 µm (BBI-43530073)

Description:

- For the aeration and supply with other gasses of a bioreactor
- For shear-sensitive culture
- Aeration with very fine bubbles
- For air, O₂, N₂, CO₂
- Frit with needed pore size available separately



To the Shop:



Alle / Verkaufsartikel / Accessories / Ventilation and Aeration / Microspargers

5 L Microsparger without frit



bbi Scancode	BBI-43530203
Manufacturer	bbi-biotech GmbH
Internal Thread	G 1/8
External Thread	M 10 x 1
Installation Depth	340 mm
Material Certificate	3.1, Rauigkeit, FDA
Country of Origin	DE 
HS-Code	73269098
Weight	0.09 kg
Material	Stainless steel 316L EPDM black

Components	1x microsparger with G 1/8, 1x O-ring [BBI-45100011], 1x coupling nut M 10 x 1 (flat) [BBI-44130009]
Consumables	Coupling nut M 10 x 1 (flat) (BBI-44130009) O-ring for items to install in 11 mm ports (package of 10 pieces) (BBI-45100011)
Related Products	Frit, G 1/8, 20 µm (BBI-43530050) Frit, G1/8, 40 µm (BBI-43530073) Frit, G1/8, 5 µm (BBI-43530070)

Description:

- For the aeration and supply with other gasses of a bioreactor
- For shear-sensitive culture
- Aeration with very fine bubbles
- For air, O₂, N₂, CO₂
- Frit with needed pore size available separately



Alle / Verkaufsartikel / Accessories / Ventilation and Aeration / Microspargers

10 L Microsparger without frit



bbi Scancode	BBI-43530204
Manufacturer	bbi-biotech GmbH
Internal Thread	G 1/8
External Thread	M 10 x 1
Installation Depth	456 mm
Material Certificate	3.1, Rauigkeit, FDA
Country of Origin	DE 
HS-Code	73269098
Weight	0.09 kg
Material	Stainless steel 316L EPDM black

Components	1x microsparger with G 1/8, 1x O-ring [BBI-45100011], 1x coupling nut M 10 x 1 (flat) [BBI-44130009]
Consumables	Coupling nut M 10 x 1 (flat) (BBI-44130009) O-ring for items to install in 11 mm ports (package of 10 pieces) (BBI-45100011)
Related Products	10 L L-Sparger, holes upwards (BBI-43530225) 10 L ring sparger, upwards-facing holes with 0.8 mm (BBI-43530254) Frit, G1/8, 40 µm (BBI-43530073)

Description:

- For the aeration and supply with other gasses of a bioreactor
- For shear-sensitive culture
- Aeration with very fine bubbles
- For air, O₂, N₂, CO₂
- Frit with needed pore size available separately



To the Shop:



Alle / Verkaufsartikel / Accessories / Ventilation and Aeration / Microspargers

0.25 L Microsparger without frit



bbi Scancode	BBI-43530205
Manufacturer	bbi-biotech GmbH
Internal Thread	M 5
External Thread	M 10 x 1
Installation Depth	125 mm
Material Certificate	3.1, Rauigkeit, FDA
Country of Origin	DE 
HS-Code	73269098
Material	Stainless steel 316L EPDM black

Components	1x microsparger with M 5, 1x O-ring [BBI-45100011], 1x coupling nut M 10 x 1 (flat) [BBI-44130009]
Consumables	Coupling nut M 10 x 1 (flat) (BBI-44130009) O-ring for items to install in 11 mm ports (package of 10 pieces) (BBI-45100011)
Related Products	0,25 L L-Sparger, holes downwards (BBI-43530228) 0,25 L L-Sparger, holes upwards (BBI-43530220) Frit, M5, 2 µm (BBI-43530061)

Description:

- For the aeration and supply with other gasses of a bioreactor
- For shear-sensitive culture
- Aeration with very fine bubbles
- For air, O₂, N₂, CO₂
- Frit with thread M5 with needed pore size available separately



To the Shop:



Alle / Verkaufsartikel / Accessories / Ventilation and Aeration / Ringspargers

2 L ring sparger, upwards-facing holes with 0.5 mm



bbi Scancode	BBI-43530080
Manufacturer	bbi-biotech GmbH
External Thread	M 10 x 1
Installation Depth	237 mm
Material Certificate	3.1, Rauigkeit, FDA
Country of Origin	DE 
HS-Code	73269098
Weight	0.06 kg
Material	Stainless steel 316L EPDM black

Components	1x gassing ring, 1x O-ring [BBI-45100011], 1x coupling nut M 10 x 1 (flat) [BBI-44130009]
Related Products	2 L ring sparger with baffle, upwards-facing holes with 0.8 mm (BBI-43530270) 2 L ring sparger, downwards-facing holes with 0.5 mm (BBI-43530089) 2 L ring sparger, upwards-facing holes with 0.8 mm (BBI-43530252)

Description:

- Ring sparger with upward-facing holes
- For intensive gassing
- With evenly arranged fine holes through which air or gas can bubble into the culture medium
- With hose connector for tubing with ID = 3.2 mm



Alle / Verkaufsartikel / Accessories / Ventilation and Aeration / Ringspargers

5 L ring sparger, upwards-facing holes with 0.5 mm



bbi Scancode	BBI-43530081
Manufacturer	bbi-biotech GmbH
External Thread	M 10 x 1
Installation Depth	332 mm
Material Certificate	3.1, Rauigkeit, FDA
Country of Origin	DE 
HS-Code	73269098
Weight	0.09 kg
Material	Stainless steel 316L EPDM black

Components	1x gassing ring, 1x O-ring [BBI-45100011], 1x coupling nut M 10 x 1 (flat) [BBI-44130009]
Related Products	5 L ring sparger with baffle, downwards-facing holes with 0.5 mm (BBI-43530244) 5 L ring sparger with baffle, downwards-facing holes with 0.8 mm (BBI-43530265) 5 L ring sparger with baffle, upwards-facing holes with 0.8 mm (BBI-43530271)

Description:

- Ring sparger with upward-facing holes
- For intensive gassing
- With evenly arranged fine holes through which air or gas can bubble into the culture medium
- With hose connector for tubing with ID = 3.2 mm



Alle / Verkaufsartikel / Accessories / Ventilation and Aeration / Ringspargers

10 L ring sparger with chicane with 2 further baffles



bbi Scancode	BBI-43530082
Manufacturer	bbi-biotech GmbH
External Thread	M 10 x 1
Installation Depth	448 mm
Material Certificate	3.1, Rauigkeit, FDA
Country of Origin	DE 
HS-Code	73269098
Material	Stainless steel 316L EPDM black

Components	1x gassing ring, 2x chicanes; 3x O-ring [BBI-45100011], 3x coupling nut M 10 x 1 (flat) [BBI-44130009]
Related Products	10 L L-Sparger, holes upwards (BBI-43530225) 10 L baffle, single (BBI-43530094) 10 L ring sparger with chicane, upwards-facing holes with 0.8 mm (BBI-43530272)
<p>Description:</p> <ul style="list-style-type: none"> • Ring sparger with upward-facing holes • Ring sparger with welded baffle • For intensive gassing • With evenly arranged fine holes through which air or gas can bubble into the culture medium • With hose connector for tubing with ID = 3.2 mm 	



Alle / Verkaufsartikel / Accessories / Ventilation and Aeration / Ringspargers

10 L ring sparger with chicane, upwards-facing holes with 0.5 mm



bbi Scancode	BBI-43530083
Manufacturer	bbi-biotech GmbH
External Thread	M 10 x 1
Installation Depth	448 mm
Material Certificate	3.1, Rauigkeit, FDA
Country of Origin	DE 
HS-Code	73269098
Material	Stainless steel 316L EPDM black

Components	1x gassing ring, 1x O-ring [BBI-45100011], 1x coupling nut M 10 x 1 (flat) [BBI-44130009]
Consumables	Coupling nut M 10 x 1 (flat) (BBI-44130009) O-ring for items to install in 11 mm ports (package of 10 pieces) (BBI-45100011) Grub screw for ring sparger (package of 10 pieces) (BBI-45110501)
Related Products	10 L ring sparger with chicane, downwards-facing holes with 0.8 mm (BBI-43530266) 10 L ring sparger, downwards-facing holes with 0.8 mm (BBI-43530260) 10 L ring sparger, upwards-facing holes with 0.8 mm (BBI-43530254)

Description:

- Ring sparger with upward-facing holes
- Ring sparger with welded baffle
- For intensive gassing
- With evenly arranged fine holes through which air or gas can bubble into the culture medium
- With hose connector for tubing with ID = 3.2 mm



To the Shop:



Alle / Verkaufsartikel / Accessories / Ventilation and Aeration / Ringspargers

0.5 L ring sparger, upwards-facing holes with 0.5 mm



bbi Scancode	BBI-43530084
Manufacturer	bbi-biotech GmbH
External Thread	M 10 x 1
Installation Depth	135 mm
Material Certificate	3.1, Rauigkeit, FDA
Country of Origin	DE 
HS-Code	73269098
Weight	0.05 kg
Material	Stainless steel 316L EPDM black

Components	1x gassing ring, 1x O-ring [BBI-45100011], 1x coupling nut M 10 x 1 (flat) [BBI-44130009]
Consumables	Coupling nut M 10 x 1 (flat) (BBI-44130009) O-ring for items to install in 11 mm ports (package of 10 pieces) (BBI-45100011) Grub screw for ring sparger (package of 10 pieces) (BBI-45110501)
Related Products	0.5 L Microsparger without frit (BBI-43530200) 0.5 L ring sparger, downwards-facing holes with 0.5 mm (BBI-43530087) Frit, M5, 20 µm (BBI-43530064)

Description:

- Ring sparger with upward-facing holes
- For intensive gassing
- With evenly arranged fine holes through which air or gas can bubble into the culture medium
- With hose connector for tubing with ID = 3.2 mm



To the Shop:



Alle / Verkaufsartikel / Accessories / Ventilation and Aeration / Ringspargers

1 L ring sparger, upwards-facing holes with 0.5 mm



bbi Scancode	BBI-43530085
Manufacturer	bbi-biotech GmbH
External Thread	M 10 x 1
Installation Depth	170 mm
Material Certificate	3.1, Rauigkeit, FDA
Country of Origin	DE 
HS-Code	73269098
Weight	0.05 kg
Material	Stainless steel 316L EPDM black

Components	1x gassing ring, 1x O-ring [BBI-45100011], 1x coupling nut M 10 x 1 (flat) [BBI-44130009]
Consumables	Coupling nut M 10 x 1 (flat) (BBI-44130009) O-ring for items to install in 11 mm ports (package of 10 pieces) (BBI-45100011) Grub screw for ring sparger (package of 10 pieces) (BBI-45110501)
<p>Description:</p> <ul style="list-style-type: none"> • Ring sparger with upward-facing holes • For intensive gassing • With evenly arranged fine holes through which air or gas can bubble into the culture medium • With hose connector for tubing with ID = 3.2 mm 	



Alle / Verkaufsartikel / Accessories / Ventilation and Aeration / Ringspargers

10 L ring sparger, upwards-facing holes with 0.5 mm



bbi Scancode	BBI-43530086
Manufacturer	bbi-biotech GmbH
External Thread	M 10 x 1
Installation Depth	448 mm
Material Certificate	3.1, Rauigkeit, FDA
Country of Origin	DE 
HS-Code	73269098
Weight	0.1 kg
Material	Stainless steel 316L EPDM black

Components	1x gassing ring, 1x O-ring [BBI-45100011], 1x coupling nut M 10 x 1 (flat) [BBI-44130009]
Related Products	10 L L-Sparger, holes upwards (BBI-43530225) 10 L Microsparger without frit (BBI-43530204) 10 L ring sparger, upwards-facing holes with 0.8 mm (BBI-43530254)
<p>Description:</p> <ul style="list-style-type: none"> • Ring sparger with upward-facing holes • For intensive gassing • With evenly arranged fine holes through which air or gas can bubble into the culture medium • With hose connector for tubing with ID = 3.2 mm 	



Alle / Verkaufsartikel / Accessories / Ventilation and Aeration / Ringspargers

0.5 L ring sparger, downwards-facing holes with 0.5 mm



bbi Scancode	BBI-43530087
Manufacturer	bbi-biotech GmbH
External Thread	M 10 x 1
Installation Depth	135 mm
Material Certificate	3.1, Rauigkeit, FDA
Country of Origin	DE 
HS-Code	73269098
Weight	0.05 kg
Material	Stainless steel 316L EPDM black

Components	1x gassing ring, 1x O-ring [BBI-45100011], 1x coupling nut M 10 x 1 (flat) [BBI-44130009]
Related Products	0.5 L Microsparger without frit (BBI-43530200) 0.5 L ring sparger, upwards-facing holes with 0.5 mm (BBI-43530084) Silicone tube 3.2 x 1.6 mm (package with 5 m) (BBI-44130605)
<p>Description:</p> <ul style="list-style-type: none"> • Ring sparger with downward-facing holes • For intensive gassing • With evenly arranged fine holes through which air or gas can bubble into the culture medium • With hose connector for tubing with ID = 3.2 mm 	



Alle / Verkaufsartikel / Accessories / Ventilation and Aeration / Ringspargers

1 L ring sparger, downwards-facing holes with 0.5 mm



bbi Scancode	BBI-43530088
Manufacturer	bbi-biotech GmbH
External Thread	M 10 x 1
Installation Depth	170 mm
Material Certificate	3.1, Rauigkeit, FDA
Country of Origin	DE 
HS-Code	73269098
Weight	0.05 kg
Material	Stainless steel 316L EPDM black

Components	1x gassing ring, 1x O-ring [BBI-45100011], 1x coupling nut M 10 x 1 (flat) [BBI-44130009]
<p>Description:</p> <ul style="list-style-type: none"> • Ring sparger with downward-facing holes • For intensive gassing • With evenly arranged fine holes through which air or gas can bubble into the culture medium • With hose connector for tubing with ID = 3.2 mm 	



Alle / Verkaufsartikel / Accessories / Ventilation and Aeration / Ringspargers

2 L ring sparger, downwards-facing holes with 0.5 mm



bbi Scancode	BBI-43530089
Manufacturer	bbi-biotech GmbH
External Thread	M 10 x 1
Installation Depth	237 mm
Material Certificate	3.1, Rauigkeit, FDA
Country of Origin	DE 
HS-Code	73269098
Weight	0.07 kg
Material	Stainless steel 316L EPDM black

Components	1x gassing ring, 1x O-ring [BBI-45100011], 1x coupling nut M 10 x 1 (flat) [BBI-44130009]
Consumables	Coupling nut M 10 x 1 (flat) (BBI-44130009) O-ring for items to install in 11 mm ports (package of 10 pieces) (BBI-45100011) Grub screw for ring sparger (package of 10 pieces) (BBI-45110501)
Related Products	2 L ring sparger with baffle, upwards-facing holes with 0.8 mm (BBI-43530270) 2 L ring sparger, upwards-facing holes with 0.5 mm (BBI-43530080) 2 L ring sparger, upwards-facing holes with 0.8 mm (BBI-43530252)

Description:

- Ring sparger with downward-facing holes
- For intensive gassing
- With evenly arranged fine holes through which air or gas can bubble into the culture medium
- With hose connector for tubing with ID = 3.2 mm



To the Shop:



Alle / Verkaufsartikel / Accessories / Ventilation and Aeration / Ringspargers

5 L ring sparger, downwards-facing holes with 0.5 mm



bbi Scancode	BBI-43530090
Manufacturer	bbi-biotech GmbH
External Thread	M 10 x 1
Installation Depth	332 mm
Material Certificate	3.1, Rauigkeit, FDA
Country of Origin	DE 
HS-Code	73269098
Weight	0.09 kg
Material	Stainless steel 316L EPDM black

Components	1x gassing ring, 1x O-ring [BBI-45100011], 1x coupling nut M 10 x 1 (flat) [BBI-44130009]
Consumables	Coupling nut M 10 x 1 (flat) (BBI-44130009) O-ring for items to install in 11 mm ports (package of 10 pieces) (BBI-45100011) Grub screw for ring sparger (package of 10 pieces) (BBI-45110501)
Related Products	5 L ring sparger with baffle, downwards-facing holes with 0.8 mm (BBI-43530265) 5 L ring sparger with baffle, upwards-facing holes with 0.5 mm (BBI-43530248) 5 L ring sparger with baffle, upwards-facing holes with 0.8 mm (BBI-43530271)

Description:

- Ring sparger with downward-facing holes
- For intensive gassing
- With evenly arranged fine holes through which air or gas can bubble into the culture medium
- With hose connector for tubing with ID = 3.2 mm



To the Shop:



Alle / Verkaufsartikel / Accessories / Ventilation and Aeration / Ringspargers

10 L ring sparger with chicane, downwards-facing holes with 0.5 mm



bbi Scancode	BBI-43530091
Manufacturer	bbi-biotech GmbH
External Thread	M 10 x 1
Installation Depth	448 mm
Material Certificate	3.1, Rauigkeit, FDA
Country of Origin	DE 
HS-Code	73269098
Material	Stainless steel 316L EPDM black

Components	1x gassing ring, 1x O-ring [BBI-45100011], 1x coupling nut M 10 x 1 (flat) [BBI-44130009]
Consumables	Coupling nut M 10 x 1 (flat) (BBI-44130009) O-ring for items to install in 11 mm ports (package of 10 pieces) (BBI-45100011) Grub screw for ring sparger (package of 10 pieces) (BBI-45110501)
Related Products	10 L L-Sparger, holes upwards (BBI-43530225) 10 L Microsparger without frit (BBI-43530204) 10 L ring sparger with chicane, downwards-facing holes with 0.8 mm (BBI-43530266)

Description:

- Ring sparger with upward-facing holes
- Ring sparger with welded baffle
- For intensive gassing
- With evenly arranged fine holes through which air or gas can bubble into the culture medium
- With hose connector for tubing with ID = 3.2 mm



Alle / Verkaufsartikel / Accessories / Ventilation and Aeration / Ringspargers

10 L ring sparger, downwards-facing holes with 0.5 mm



bbi Scancode	BBI-43530092
Manufacturer	bbi-biotech GmbH
External Thread	M 10 x 1
Installation Depth	448 mm
Material Certificate	3.1, Rauigkeit, FDA
Country of Origin	DE 
HS-Code	73269098
Weight	0.1 kg
Material	Stainless steel 316L EPDM black

Components	1x gassing ring, 1x O-ring [BBI-45100011], 1x coupling nut M 10 x 1 (flat) [BBI-44130009]
Consumables	Coupling nut M 10 x 1 (flat) (BBI-44130009) O-ring for items to install in 11 mm ports (package of 10 pieces) (BBI-45100011) Grub screw for ring sparger (package of 10 pieces) (BBI-45110501)
Related Products	10 L L-Sparger, holes downwards (BBI-43530233) 10 L Microsparger without frit (BBI-43530204) 10 L ring sparger with chicane, upwards-facing holes with 0.8 mm (BBI-43530272)

Description:

- Ring sparger with downward-facing holes
- For intensive gassing
- With evenly arranged fine holes through which air or gas can bubble into the culture medium
- With hose connector for tubing with ID = 3.2 mm



To the Shop:



Alle / Verkaufsartikel / Accessories / Ventilation and Aeration / Ringspargers

20 L ring sparger, downwards-facing holes



bbi Scancode	BBI-43530093
Manufacturer	bbi-biotech GmbH
External Thread	M 10 x 1
Material Certificate	3.1, Rauigkeit, FDA
Country of Origin	DE 
HS-Code	73269098
Material	Stainless steel 316L EPDM black

Components	1x gassing ring, 1x O-ring [BBI-45100011], 1x coupling nut M 10 x 1 (flat) [BBI-44130009]
Related Products	20 L Pt100 casing (BBI-43430022) 20 L Rushton impeller (BBI-43230704) 20 L aeration basket (BBI-43530104)
<p>Description:</p> <ul style="list-style-type: none"> • Ring sparger with downward-facing holes • For intensive gassing • With evenly arranged fine holes through which air or gas can bubble into the culture medium • With hose connector for tubing with ID = 3.2 mm 	



Alle / Verkaufsartikel / Accessories / Ventilation and Aeration / Ringspargers

0.5 L ring sparger with baffle, downwards-facing holes with 0.5 mm



bbi Scancode	BBI-43530241
Manufacturer	bbi-biotech GmbH
External Thread	M 10 x 1
Installation Depth	135 mm
Material Certificate	3.1, Rauigkeit, FDA
Country of Origin	DE 
HS-Code	73269098
Material	Stainless steel 316L EPDM black

Components	1x gassing ring with baffle, 1x O-ring [BBI-45100011], 1x coupling nut M 10 x 1 (flat) [BBI-44130009]
Related Products	0.5 L ring sparger with baffle, upwards-facing holes with 0.5 mm (BBI-43530245) 0.5 L ring sparger, downwards-facing holes with 0.5 mm (BBI-43530087) 0.5 L ring sparger, upwards-facing holes with 0.5 mm (BBI-43530084)

Description:

- Ring sparger with downward-facing holes
- For intensive gassing
- With evenly arranged fine holes through which air or gas can bubble into the culture medium
- With hose connector for tubing with ID = 3.2 mm
- Baffles enable an enhanced mixing of cells, nutrients, and gases
- Improved mass transfer and oxygen distribution
- Optimized microbial culture productivity
- Disruption of liquid flow for efficient nutrient distribution
- Increased turbulence leading to better microbial growth



Alle / Verkaufsartikel / Accessories / Ventilation and Aeration / Ringspargers

1 L ring sparger with baffle, downwards-facing holes with 0.5 mm



bbi Scancode	BBI-43530242
Manufacturer	bbi-biotech GmbH
External Thread	M 10 x 1
Installation Depth	170 mm
Material Certificate	3.1, Rauigkeit, FDA
Country of Origin	DE 
HS-Code	73269098
Material	Stainless steel 316L EPDM black

Components

1x gassing ring with baffle, 1x O-ring [BBI-45100011], 1x coupling nut M 10 x 1 (flat) [BBI-44130009]

Description:

- Ring sparger with downward-facing holes
- For intensive gassing
- With evenly arranged fine holes through which air or gas can bubble into the culture medium
- With hose connector for tubing with ID = 3.2 mm
- Baffles enable an enhanced mixing of cells, nutrients, and gases
- Improved mass transfer and oxygen distribution
- Optimized microbial culture productivity
- Disruption of liquid flow for efficient nutrient distribution
- Increased turbulence leading to better microbial growth



To the Shop:



Alle / Verkaufsartikel / Accessories / Ventilation and Aeration / Ringspargers

2 L ring sparger with baffle, downwards-facing holes with 0.5 mm



bbi Scancode	BBI-43530243
Manufacturer	bbi-biotech GmbH
External Thread	M 10 x 1
Installation Depth	237 mm
Material Certificate	3.1, Rauigkeit, FDA
Country of Origin	DE 
HS-Code	73269098
Material	Stainless steel 316L EPDM black

Components	1x gassing ring with baffle, 1x O-ring [BBI-45100011], 1x coupling nut M 10 x 1 (flat) [BBI-44130009]
Related Products	2 L Microsparger without frit (BBI-43530202) 2 L ring sparger with baffle, upwards-facing holes with 0.8 mm (BBI-43530270) 2 L ring sparger, upwards-facing holes with 0.8 mm (BBI-43530252)

Description:

- Ring sparger with downward-facing holes
- For intensive gassing
- With evenly arranged fine holes through which air or gas can bubble into the culture medium
- With hose connector for tubing with ID = 3.2 mm
- Baffles enable an enhanced mixing of cells, nutrients, and gases
- Improved mass transfer and oxygen distribution
- Optimized microbial culture productivity
- Disruption of liquid flow for efficient nutrient distribution
- Increased turbulence leading to better microbial growth



Alle / Verkaufsartikel / Accessories / Ventilation and Aeration / Ringspargers

5 L ring sparger with baffle, downwards-facing holes with 0.5 mm



bbi Scancode	BBI-43530244
Manufacturer	bbi-biotech GmbH
External Thread	M 10 x 1
Installation Depth	332 mm
Material Certificate	3.1, Rauigkeit, FDA
Country of Origin	DE 
HS-Code	73269098
Material	Stainless steel 316L EPDM black

Components	1x gassing ring with baffle, 1x O-ring [BBI-45100011], 1x coupling nut M 10 x 1 (flat) [BBI-44130009]
Related Products	5 L ring sparger with baffle, downwards-facing holes with 0.8 mm (BBI-43530265) 5 L ring sparger with baffle, upwards-facing holes with 0.5 mm (BBI-43530248) 5 L ring sparger with baffle, upwards-facing holes with 0.8 mm (BBI-43530271)

Description:

- Ring sparger with downward-facing holes
- For intensive gassing
- With evenly arranged fine holes through which air or gas can bubble into the culture medium
- With hose connector for tubing with ID = 3.2 mm
- Baffles enable an enhanced mixing of cells, nutrients, and gases
- Improved mass transfer and oxygen distribution
- Optimized microbial culture productivity
- Disruption of liquid flow for efficient nutrient distribution
- Increased turbulence leading to better microbial growth



Alle / Verkaufsartikel / Accessories / Ventilation and Aeration / Ringspargers

0.5 L ring sparger with baffle, upwards-facing holes with 0.5 mm



bbi Scancode	BBI-43530245
Manufacturer	bbi-biotech GmbH
External Thread	M 10 x 1
Installation Depth	135 mm
Material Certificate	3.1, Rauigkeit, FDA
Country of Origin	DE 
HS-Code	73269098
Material	Stainless steel 316L EPDM black

Components	1x gassing ring with baffle, 1x O-ring [BBI-45100011], 1x coupling nut M 10 x 1 (flat) [BBI-44130009]
Related Products	0.5 L Microsparger without frit (BBI-43530200) 0.5 L ring sparger with baffle, downwards-facing holes with 0.5 mm (BBI-43530241) Frit, M5, 2 µm (BBI-43530061)

Description:

- Ring sparger with upward-facing holes
- For intensive gassing
- With evenly arranged fine holes through which air or gas can bubble into the culture medium
- With hose connector for tubing with ID = 3.2 mm
- Baffles enable an enhanced mixing of cells, nutrients, and gases
- Improved mass transfer and oxygen distribution
- Optimized microbial culture productivity
- Disruption of liquid flow for efficient nutrient distribution
- Increased turbulence leading to better microbial growth



Alle / Verkaufsartikel / Accessories / Ventilation and Aeration / Ringspargers

1 L ring sparger with baffle, upwards-facing holes with 0.5 mm



bbi Scancode	BBI-43530246
Manufacturer	bbi-biotech GmbH
External Thread	M 10 x 1
Installation Depth	170 mm
Material Certificate	3.1, Rauigkeit, FDA
Country of Origin	DE 
HS-Code	73269098
Material	Stainless steel 316L EPDM black

Components

1x gassing ring with baffle, 1x O-ring [BBI-45100011], 1x coupling nut M 10 x 1 (flat) [BBI-44130009]

Description:

- Ring sparger with upward-facing holes
- For intensive gassing
- With evenly arranged fine holes through which air or gas can bubble into the culture medium
- With hose connector for tubing with ID = 3.2 mm
- Baffles enable an enhanced mixing of cells, nutrients, and gases
- Improved mass transfer and oxygen distribution
- Optimized microbial culture productivity
- Disruption of liquid flow for efficient nutrient distribution
- Increased turbulence leading to better microbial growth



To the Shop:



Alle / Verkaufsartikel / Accessories / Ventilation and Aeration / Ringspargers

2 L ring sparger with baffle, upwards-facing holes with 0.5 mm



bbi Scancode	BBI-43530247
Manufacturer	bbi-biotech GmbH
External Thread	M 10 x 1
Installation Depth	237 mm
Material Certificate	3.1, Rauigkeit, FDA
Country of Origin	DE 
HS-Code	73269098
Material	Stainless steel 316L EPDM black

Components	1x gassing ring with baffle, 1x O-ring [BBI-45100011], 1x coupling nut M 10 x 1 (flat) [BBI-44130009]
Related Products	2 L ring sparger with baffle, upwards-facing holes with 0.8 mm (BBI-43530270) 2 L ring sparger, downwards-facing holes with 0.8 mm (BBI-43530258) 2 L ring sparger, upwards-facing holes with 0.8 mm (BBI-43530252)

Description:

- Ring sparger with upward-facing holes
- For intensive gassing
- With evenly arranged fine holes through which air or gas can bubble into the culture medium
- With hose connector for tubing with ID = 3.2 mm
- Baffles enable an enhanced mixing of cells, nutrients, and gases
- Improved mass transfer and oxygen distribution
- Optimized microbial culture productivity
- Disruption of liquid flow for efficient nutrient distribution
- Increased turbulence leading to better microbial growth



Alle / Verkaufsartikel / Accessories / Ventilation and Aeration / Ringspargers

5 L ring sparger with baffle, upwards-facing holes with 0.5 mm



bbi Scancode	BBI-43530248
Manufacturer	bbi-biotech GmbH
External Thread	M 10 x 1
Installation Depth	332 mm
Material Certificate	3.1, Rauigkeit, FDA
Country of Origin	DE 
HS-Code	73269098
Material	Stainless steel 316L EPDM black

Components	1x gassing ring with baffle, 1x O-ring [BBI-45100011], 1x coupling nut M 10 x 1 (flat) [BBI-44130009]
Related Products	5 L ring sparger with baffle, downwards-facing holes with 0.5 mm (BBI-43530244) 5 L ring sparger with baffle, downwards-facing holes with 0.8 mm (BBI-43530265) 5 L ring sparger with baffle, upwards-facing holes with 0.8 mm (BBI-43530271)

Description:

- Ring sparger with upward-facing holes
- For intensive gassing
- With evenly arranged fine holes through which air or gas can bubble into the culture medium
- With hose connector for tubing with ID = 3.2 mm
- Baffles enable an enhanced mixing of cells, nutrients, and gases
- Improved mass transfer and oxygen distribution
- Optimized microbial culture productivity
- Disruption of liquid flow for efficient nutrient distribution
- Increased turbulence leading to better microbial growth



Alle / Verkaufsartikel / Accessories / Ventilation and Aeration / Ringspargers

0.5 L ring sparger, upwards-facing holes with 0.8 mm



bbi Scancode	BBI-43530250
Country of Origin	DE 
HS-Code	73269098

Components	
Related Products	<p>0.5 L ring sparger, downwards-facing holes with 0.8 mm (BBI-43530256)</p> <p>1 L ring sparger, downwards-facing holes with 0.5 mm (BBI-43530088)</p> <p>Silicone tube 3.2 x 1.6 mm (package with 5 m) (BBI-44130605)</p>
<p>Description:</p> <p>Installation depth: 135 mm</p> <p>hose olive for connecting hoses with Di = 3.2 mm</p> <p>components</p> <ul style="list-style-type: none"> • 1 x gassing ring • 1 x O-ring [BBI-45100011] • 1 x coupling nut M 10 x 1 (flat) [BBI-44130009] 	



Alle / Verkaufsartikel / Accessories / Ventilation and Aeration / Ringspargers

1 L ring sparger, upwards-facing holes with 0.8 mm



bbi Scancode	BBI-43530251
Country of Origin	DE 
HS-Code	73269098

Components

Description:

Installation depth: 170 mm, hose olive for connecting hoses with Di = 3.2 mm

components:

- 1 x gassing ring
- 1 x O-ring [BBI-45100011]
- 1 x coupling nut M 10 x 1 (flat) [BBI-44130009]



To the Shop:



Alle / Verkaufsartikel / Accessories / Ventilation and Aeration / Ringspargers

2 L ring sparger, upwards-facing holes with 0.8 mm



bbi Scancode	BBI-43530252
Manufacturer	bbi-biotech GmbH
External Thread	M 10 x 1
Installation Depth	237 mm
Material Certificate	3.1, Rauigkeit, FDA
Country of Origin	DE 
HS-Code	73269098
Material	Stainless steel 316L EPDM black

Components	1x gassing ring, 1x O-ring [BBI-45100011], 1x coupling nut M 10 x 1 (flat) [BBI-44130009]
Related Products	2 L Microsparger without frit (BBI-43530202) 2 L ring sparger with baffle, upwards-facing holes with 0.8 mm (BBI-43530270) 2 L ring sparger, downwards-facing holes with 0.8 mm (BBI-43530258)
<p>Description:</p> <p>Installation depth: 237 mm</p> <p>hose olive for connecting hoses with Di = 3.2 mm</p> <p>Components:</p> <ul style="list-style-type: none"> • 1 x gassing ring • 1 x O-ring [BBI-45100011] • 1 x coupling nut M 10 x 1 (flat) [BBI-44130009] 	



Alle / Verkaufsartikel / Accessories / Ventilation and Aeration / Ringspargers

5 L ring sparger, upwards-facing holes with 0.8 mm



bbi Scancode	BBI-43530253
Manufacturer	bbi-biotech GmbH
External Thread	M 10 x 1
Country of Origin	DE 
HS-Code	73269098

Components	1x gassing ring, 1x O-ring [BBI-45100011], 1x coupling nut M 10 x 1 (flat) [BBI-44130009]
Related Products	<p>5 L ring sparger, downwards-facing holes with 0.5 mm (BBI-43530090)</p> <p>5 L ring sparger, downwards-facing holes with 0.8 mm (BBI-43530259)</p> <p>5 L ring sparger, upwards-facing holes with 0.5 mm (BBI-43530081)</p>
<p>Description:</p> <p>Installation depth: 332 mm</p> <p>hose olive for connecting hoses with Di = 3,2 mm</p> <p>components:</p> <ul style="list-style-type: none"> • 1 x gassing ring • 1 x O-ring [BBI-45100011] • 1 x coupling nut M 10 x 1 (flat) [BBI-44130009] 	



Alle / Verkaufsartikel / Accessories / Ventilation and Aeration / Ringspargers

10 L ring sparger, upwards-facing holes with 0.8 mm



bbi Scancode	BBI-43530254
Country of Origin	DE 
HS-Code	73269098

Components	
Related Products	<p>10 L L-Sparger, holes downwards (BBI-43530233)</p> <p>10 L Microsparger without frit (BBI-43530204)</p> <p>10 L ring sparger with chicane, upwards-facing holes with 0.8 mm (BBI-43530272)</p>
<p>Description:</p> <p>Installation depth: 448 mm, hose olive for connecting hoses with Di = 3,2 mm</p> <p>components:</p> <ul style="list-style-type: none"> • 1 x gassing ring • 1 x o-ring [BBI-45100011] • 1 x coupling nut M flat [BBI-44130009] 	



Alle / Verkaufsartikel / Accessories / Ventilation and Aeration / Ringspargers

0.5 L ring sparger, downwards-facing holes with 0.8 mm



bbi Scancode	BBI-43530256
Country of Origin	DE 
HS-Code	73269098

Components	
Related Products	0.5 L lid (BBI-44430002) 0.5 L ring sparger with baffle, upwards-facing holes with 0.8 mm (BBI-43530268) 0.5 L ring sparger, upwards-facing holes with 0.8 mm (BBI-43530250)
Description: Installation depth: 135 mm hose olive for connecting hoses with Di = 3.2 mm components: <ul style="list-style-type: none"> • 1 x gassing ring • 1 x O-ring [BBI-45100011] • 1 x coupling nut M 10 x 1 (flat) [BBI-44130009] 	



To the Shop:



Alle / Verkaufsartikel / Accessories / Ventilation and Aeration / Ringspargers

1 L ring sparger, downwards-facing holes with 0.8 mm



bbi Scancode	BBI-43530257
Country of Origin	DE 
HS-Code	73269098

Components

Description:

Installation depth: 170 mm

hose olive for connecting hoses with Di = 3.2 mm

components:

- 1 x gassing ring
- 1 x O-ring [BBI-45100011]
- 1 x coupling nut M 10 x 1 (flat) [BBI-44130009]



To the Shop:



Alle / Verkaufsartikel / Accessories / Ventilation and Aeration / Ringspargers

2 L ring sparger, downwards-facing holes with 0.8 mm



bbi Scancode	BBI-43530258
Manufacturer	bbi-biotech GmbH
External Thread	M 10 x 1
Installation Depth	237 mm
Material Certificate	3.1, Rauigkeit, FDA
Country of Origin	DE 
HS-Code	73269098
Material	Stainless steel 316L EPDM black

Components	1x gassing ring, 1x O-ring [BBI-45100011], 1x coupling nut M 10 x 1 (flat) [BBI-44130009]
Related Products	2 L Microsparger without frit (BBI-43530202) 2 L ring sparger with baffle, upwards-facing holes with 0.8 mm (BBI-43530270) 2 L ring sparger, upwards-facing holes with 0.8 mm (BBI-43530252)
<p>Description:</p> <p>Installation depth: 237 mm</p> <p>hose olive for connecting hoses with Di = 3.2 mm</p> <p>components:</p> <ul style="list-style-type: none"> • 1 x gassing ring • 1 x O-ring [BBI-45100011] • 1 x coupling nut M 10 x 1 (flat) [BBI-44130009] 	



Alle / Verkaufsartikel / Accessories / Ventilation and Aeration / Ringspargers

5 L ring sparger, downwards-facing holes with 0.8 mm



bbi Scancode	BBI-43530259
Manufacturer	bbi-biotech GmbH
External Thread	M 10 x 1
Country of Origin	DE 
HS-Code	73269098

Components	1x gassing ring, 1x O-ring [BBI-45100011], 1x coupling nut M 10 x 1 (flat) [BBI-44130009]
Related Products	<p>5 L ring sparger with baffle, downwards-facing holes with 0.5 mm (BBI-43530244)</p> <p>5 L ring sparger, upwards-facing holes with 0.5 mm (BBI-43530081)</p> <p>5 L ring sparger, upwards-facing holes with 0.8 mm (BBI-43530253)</p>
<p>Description:</p> <p>Installation depth: 332 mm</p> <p>hose olive for connecting hoses with Di = 3,2 mm</p> <p>Components:</p> <ul style="list-style-type: none"> • 1 x gassing ring • 1 x O-ring [BBI-45100011] • 1 x coupling nut M 10 x 1 (flat) [BBI-44130009] 	



Alle / Verkaufsartikel / Accessories / Ventilation and Aeration / Ringspargers

10 L ring sparger, downwards-facing holes with 0.8 mm



bbi Scancode	BBI-43530260
Country of Origin	DE 
HS-Code	73269098

Components	
Related Products	<p>10 L L-Sparger, holes upwards (BBI-43530225)</p> <p>10 L Microsparger without frit (BBI-43530204)</p> <p>10 L ring sparger with chicane, downwards-facing holes with 0.8 mm (BBI-43530266)</p>
<p>Description:</p> <p>Installation depth: 448 mm</p> <p>hose olive for connecting hoses with Di = 3.2 mm</p> <p>Components:</p> <ul style="list-style-type: none"> • 1 x gassing ring • 1 x O-ring [BBI-45100011] • 1 x coupling nut M 10 x 1 (flat) [BBI-44130009] 	



Alle / Verkaufsartikel / Accessories / Ventilation and Aeration / Ringspargers

0.5 L ring sparger with baffle, downwards-facing holes with 0.8 mm



bbi Scancode	BBI-43530262
Country of Origin	DE 
HS-Code	73269098

Components	
Related Products	<p>0.5 L Microsparger without frit (BBI-43530200)</p> <p>0.5 L lid (BBI-44430002)</p> <p>0.5 L ring sparger with baffle, upwards-facing holes with 0.8 mm (BBI-43530268)</p>
<p>Description:</p> <p>Installation depth: 135 mm</p> <p>hose olive for connecting hoses with Di = 3.2 mm</p> <p>components:</p> <ul style="list-style-type: none"> • 1 x gassing ring • 1 x O-ring [BBI-45100011] • 1 x coupling nut M 10 x 1 (flat) [BBI-44130009] 	



Alle / Verkaufsartikel / Accessories / Ventilation and Aeration / Ringspargers

1 L ring sparger with baffle, downwards-facing holes with 0.8 mm



bbi Scancode	BBI-43530263
Country of Origin	DE 
HS-Code	73269098

Components

Description:

Einbautiefe: 170 mm

hose olive for connecting hoses with $D_i = 3.2$ mm

components:

- 1 x gassing ring
- 1 x O-ring [BBI-45100011]
- 1 x coupling nut M 10 x 1 (flat) [BBI-44130009]



To the Shop:



Alle / Verkaufsartikel / Accessories / Ventilation and Aeration / Ringspargers

2 L ring sparger with baffle, downwards-facing holes with 0.8 mm



bbi Scancode	BBI-43530264
Manufacturer	bbi-biotech GmbH
External Thread	M 10 x 1
Installation Depth	237 mm
Material Certificate	3.1, Rauigkeit, FDA
Country of Origin	DE 
HS-Code	73269098
Material	Stainless steel 316L EPDM black

Components	1x gassing ring with baffle, 1x O-ring [BBI-45100011], 1x coupling nut M 10 x 1 (flat) [BBI-44130009]
Related Products	2 L Microsparger without frit (BBI-43530202) 2 L ring sparger with baffle, upwards-facing holes with 0.8 mm (BBI-43530270) 2 L ring sparger, upwards-facing holes with 0.8 mm (BBI-43530252)
<p>Description:</p> <p>Einbautiefe: 237 mm</p> <p>hose olive for connecting hoses with Di = 3.2 mm</p> <p>components:</p> <ul style="list-style-type: none"> • 1 x gassing ring • 1 x O-ring [BBI-45100011] • 1 x coupling nut M 10 x 1 (flat) [BBI-44130009] 	



Alle / Verkaufsartikel / Accessories / Ventilation and Aeration / Ringspargers

5 L ring sparger with baffle, downwards-facing holes with 0.8 mm



bbi Scancode	BBI-43530265
Manufacturer	bbi-biotech GmbH
External Thread	M 10 x 1
Installation Depth	332 mm
Material Certificate	3.1, Rauigkeit, FDA
Country of Origin	DE 
HS-Code	73269098
Material	Stainless steel 316L EPDM black

Components	1x gassing ring with baffle, 1x O-ring [BBI-45100011], 1x coupling nut M 10 x 1 (flat) [BBI-44130009]
Related Products	5 L ring sparger with baffle, downwards-facing holes with 0.5 mm (BBI-43530244) 5 L ring sparger with baffle, upwards-facing holes with 0.5 mm (BBI-43530248) 5 L ring sparger with baffle, upwards-facing holes with 0.8 mm (BBI-43530271)
<p>Description:</p> <p>Einbautiefe: 332 mm</p> <p>hose olive for connecting hoses with Di = 3.2 mm</p> <p>components:</p> <ul style="list-style-type: none"> • 1 x gassing ring • 1 x O-ring [BBI-45100011] • 1 x coupling nut M 10 x 1 (flat) [BBI-44130009] 	



Alle / Verkaufsartikel / Accessories / Ventilation and Aeration / Ringspargers

10 L ring sparger with chicane, downwards-facing holes with 0.8 mm



bbi Scancode	BBI-43530266
Country of Origin	DE 
HS-Code	73269098

Components	
Related Products	<p>10 L L-Sparger, holes upwards (BBI-43530225)</p> <p>10 L Microsparger without frit (BBI-43530204)</p> <p>10 L ring sparger, upwards-facing holes with 0.8 mm (BBI-43530254)</p>
<p>Description:</p> <p>Installation depth: 448 mm</p> <p>hose olive for connecting hoses with Di = 3.2 mm</p> <p>components:</p> <ul style="list-style-type: none"> • 1 x gassing ring • 1 x O-ring [BBI-45100011] • 1 x coupling nut M 10 x 1 (flat) [BBI-44130009] 	



Alle / Verkaufsartikel / Accessories / Ventilation and Aeration / Ringspargers

0.5 L ring sparger with baffle, upwards-facing holes with 0.8 mm



bbi Scancode	BBI-43530268
Country of Origin	DE 
HS-Code	73269098

Components	
Related Products	<p>0.5 L Microsparger without frit (BBI-43530200)</p> <p>0.5 L double-wall vessel, complete with accessories MO without sensors (BBI-44438005)</p> <p>0.5 L ring sparger with baffle, downwards-facing holes with 0.8 mm (BBI-43530262)</p>
<p>Description:</p> <p>Installation depth: 135 mm</p> <p>hose olive for connecting hoses with Di = 3.2 mm</p> <p>components:</p> <ul style="list-style-type: none"> • 1 x gassing ring • 1 x O-ring [BBI-45100011] • 1 x coupling nut M 10 x 1 (flat) [BBI-44130009] 	



Alle / Verkaufsartikel / Accessories / Ventilation and Aeration / Ringspargers

1 L ring sparger with baffle, upwards-facing holes with 0.8 mm



bbi Scancode	BBI-43530269
Country of Origin	DE 
HS-Code	73269098

Components

Description:

Einbautiefe: 170 mm

hose olive for connecting hoses with $D_i = 3.2$ mm

components:

- 1 x gassing ring
- 1 x O-ring [BBI-45100011]
- 1 x coupling nut M 10 x 1 (flat) [BBI-44130009]



To the Shop:



Alle / Verkaufsartikel / Accessories / Ventilation and Aeration / Ringspargers

2 L ring sparger with baffle, upwards-facing holes with 0.8 mm



bbi Scancode	BBI-43530270
Manufacturer	bbi-biotech GmbH
External Thread	M 10 x 1
Installation Depth	237 mm
Material Certificate	3.1, Rauigkeit, FDA
Country of Origin	DE 
HS-Code	73269098
Material	Stainless steel 316L EPDM black

Components	1x gassing ring with baffle, 1x O-ring [BBI-45100011], 1x coupling nut M 10 x 1 (flat) [BBI-44130009]
Related Products	2 L ring sparger with baffle, downwards-facing holes with 0.8 mm (BBI-43530264) 2 L ring sparger, downwards-facing holes with 0.8 mm (BBI-43530258) 2 L ring sparger, upwards-facing holes with 0.8 mm (BBI-43530252)
<p>Description:</p> <p>Einbautiefe: 237 mm</p> <p>hose olive for connecting hoses with Di = 3.2 mm</p> <p>components:</p> <ul style="list-style-type: none"> • 1 x gassing ring • 1 x O-ring [BBI-45100011] • 1 x coupling nut M 10 x 1 (flat) [BBI-44130009] 	



Alle / Verkaufsartikel / Accessories / Ventilation and Aeration / Ringspargers

5 L ring sparger with baffle, upwards-facing holes with 0.8 mm



bbi Scancode	BBI-43530271
Manufacturer	bbi-biotech GmbH
External Thread	M 10 x 1
Installation Depth	332 mm
Material Certificate	3.1, Rauigkeit, FDA
Country of Origin	DE 
HS-Code	73269098
Material	Stainless steel 316L EPDM black

Components	1x gassing ring with baffle, 1x O-ring [BBI-45100011], 1x coupling nut M 10 x 1 (flat) [BBI-44130009]
Related Products	5 L ring sparger with baffle, downwards-facing holes with 0.8 mm (BBI-43530265) 5 L ring sparger, downwards-facing holes with 0.8 mm (BBI-43530259) 5 L ring sparger, upwards-facing holes with 0.8 mm (BBI-43530253)
<p>Description:</p> <p>Einbautiefe: 332 mm</p> <p>hose olive for connecting hoses with Di = 3.2 mm</p> <p>components:</p> <ul style="list-style-type: none"> • 1 x gassing ring • 1 x O-ring [BBI-45100011] • 1 x coupling nut M 10 x 1 (flat) [BBI-44130009] 	



Alle / Verkaufsartikel / Accessories / Ventilation and Aeration / Ringspargers

10 L ring sparger with chicane, upwards-facing holes with 0.8 mm



bbi Scancode	BBI-43530272
Country of Origin	DE 
HS-Code	73269098

Components	
Related Products	<p>10 L L-Sparger, holes upwards (BBI-43530225)</p> <p>10 L Microsparger without frit (BBI-43530204)</p> <p>10 L ring sparger, upwards-facing holes with 0.5 mm (BBI-43530086)</p>
<p>Description:</p> <p>Installation depth: 448 mm</p> <p>hose olive for connecting hoses with Di = 3.2 mm</p> <p>Components:</p> <ul style="list-style-type: none"> • 1 x gassing ring • 1 x O-ring [BBI-45100011] • 1 x coupling nut M 10 x 1 (flat) [BBI-44130009] 	



Alle / Verkaufsartikel / Accessories / Ventilation and Aeration / Ringspargers

Ring sparger special, upwards-facing holes, installation depth: 850 mm



bbi Scancode	BBI-43530411
Manufacturer	bbi-biotech GmbH
External Thread	M 10 x 1
Installation Depth	850 mm
Material Certificate	3.1, Rauigkeit, FDA
Country of Origin	DE 
Material	Stainless steel 316L EPDM black

Components	1x gassing ring with baffle, 1x O-ring [BBI-45100011], 1x coupling nut M 10 x 1 (flat) [BBI-44130009]
Related Products	10 L ring sparger with chicane, downwards-facing holes with 0.8 mm (BBI-43530266) 10 L ring sparger, upwards-facing holes with 0.5 mm (BBI-43530086) 5 L ring sparger, downwards-facing holes with 0.8 mm (BBI-43530259)

Description:

- Ring sparger with upward-facing holes
- For intensive gassing
- With evenly arranged fine holes through which air or gas can bubble into the culture medium
- With hose connector for tubing with ID = 3.2 mm



Alle / Verkaufsartikel / Accessories / Blind plugs / Blind plugs autoclavable

Blind plug for 19 mm ports M 26 x 1



bbi Scancode	BBI-44130201
Manufacturer	bbi-biotech GmbH
External Thread	M 26 x 1
Material Certificate	3.1, Rauigkeit, FDA
Country of Origin	DE 
HS-Code	73269098
Weight	0.1 kg
Material	Stainless steel 316L EPDM black

Components	1x blind plug; 1x o-ring [BBI-45100015]
Consumables	O-ring for items to install in M 26 x 1 ports (package of 10 pieces) (BBI-45100015)
Related Products	4-way addition port M 26 x 1 (BBI-43630202) Membrane holder M 26 x 1 (BBI-44130018) Probe adapter 19/12 mm, M 26 x 1, Pg 13,5 (BBI-44130108)

Description:

- Blind plug for 19 mm ports
- To close unused M 26 x 1 ports in the bioreactor
- This blind plug is mounted from the top in the lid
- Spare part for fermenters and bioreactors



To the Shop:



Alle / Verkaufsartikel / Accessories / Blind plugs / Blind plugs autoclavable

Blind plug Pg 13.5



bbi Scancode	BBI-44130206
Manufacturer	bbi-biotech GmbH
External Thread	Pg 13,5
Material Certificate	3.1, Rauigkeit, FDA
Country of Origin	DE 
HS-Code	73269098
Weight	0.06 kg
Material	Stainless steel 316L EPDM black

Components	1x blind plug, 1x seal [BBI-44130210]
Consumables	Flat seal for 12 mm ports (Package of 5 pieces) (BBI-44130210)
Related Products	1-way addition port 4 mm, PG 13.5 (BBI-43630254) 10 L dip tube for harvesting, fix, ID = 8 mm, Pg 13,5 (BBI-43630018) Blind plug Pg 13.5 with slot (BBI-44130217)

Description:

- Blind plug for 12 mm ports
- For closing unused Pg 13.5 ports in the bioreactor
- This blind plug is mounted from the top into the lid
- Flat seal [BBI-44130210] is included, but is also available separately in a pack of 5



To the Shop:



Alle / Verkaufsartikel / Accessories / Blind plugs / Blind plugs autoclavable

Blind plug M 10 x 1



bbi Scancode	BBI-44130207
Manufacturer	bbi-biotech GmbH
External Thread	M 10 x 1
Material Certificate	3.1, Rauigkeit, FDA
Country of Origin	DE 
HS-Code	73269098
Weight	0.3 kg
Material	Stainless steel 316L EPDM black

Components	1x blind plug, 1x coupling nut flat [BBI-44130009], 1x O-ring [BBI-45100011]
Consumables	O-ring for items to install in 11 mm ports (package of 10 pieces) (BBI-45100011) Coupling nut M 10 x 1 (flat) (BBI-44130009)
Related Products	Blind plug for 11 mm ports M 10 x 1 (for in-situ lids) (BBI-44130212) Inoculation port with septum for 11 mm ports (BBI-43630200) Universal adapter 6-4 (BBI-43930003)

Description:

- Blind plugs for 11 mm ports
- For closing unused M 10 x 1 ports in the bioreactor
- This blind plug is mounted from the bottom into the lid



To the Shop:



Alle / Verkaufsartikel / Accessories / Blind plugs / Blind plugs autoclavable

Blind plug M 38 x 1.5



bbi Scancode	BBI-44130208
Manufacturer	bbi-biotech GmbH
External Thread	M 38 x 1,5
Material Certificate	3.1, Rauigkeit, FDA
Country of Origin	DE 
HS-Code	73269098
Material	Stainless steel 316L EPDM black

Components	1x blind plug; 1x o-ring
Related Products	2 L stirrer shaft, 10 mm (BBI-43230041) 5 L stirrer shaft, 10 mm (BBI-43230046) Reducing adapter M 38 x 1.5 to M 26 x 1 (BBI-44130103)
<p>Description:</p> <ul style="list-style-type: none"> • Blind plug complete (with O-ring) with thread M 38 x 1.5 • For the sealing of motor flanges (stirrer shaft port) of standard bioreactors • This blind plug is mounted from above in the cover Spare part 	



Alle / Verkaufsartikel / Accessories / Blind plugs / Blind plugs autoclavable

Blind plug Pg 42



bbi Scancode	BBI-44130215
Manufacturer	bbi-biotech GmbH
External Thread	Pg 42
Material Certificate	3.1, Rauigkeit, FDA
Country of Origin	DE 
HS-Code	73269098
Material	Stainless steel 316L EPDM black

Components	1x blind plug; 1x o-ring
Related Products	Blind plug M 10 x 1 (BBI-44130207) Blind plug Pg 13.5 (BBI-44130206) O-ring for blind plug Pg 42 (BBI-45100016)
<p>Description:</p> <ul style="list-style-type: none"> • Blind plug for Pg 42 ports • For closing unused 2"-ports in the bioreactor • This blind plug is mounted from the top • Delivery with o-ring • Spare part for fermentors and bioreactors 	



Alle / Verkaufsartikel / Accessories / Blind plugs / Blind plugs autoclavable

Blind plug Pg 13.5 with slot



bbi Scancode	BBI-44130217
Manufacturer	bbi-biotech GmbH
External Thread	Pg 13,5
Material Certificate	3.1, Rauigkeit, FDA
Country of Origin	DE 
HS-Code	73269098
Weight	0.06 kg
Material	Stainless steel 316L EPDM black

Components	1x blind plug, 1x seal [BBI-44130210]
Consumables	Flat seal for 12 mm ports (Package of 5 pieces) (BBI-44130210)
Related Products	1-way addition port 4 mm, PG 13.5 (BBI-43630254) 10 L dip tube for harvesting, fix, ID = 8 mm, Pg 13,5 (BBI-43630018) Blind plug Pg 13.5 (BBI-44130206)

Description:

- Blind plug for 12 mm ports
- For closing unused Pg 13.5 ports in the bioreactor
- This blind plug is mounted from the top into the lid
- Flat seal [BBI-44130210] is included, but is also available separately in a pack of 5



Alle / Verkaufsartikel / Accessories / Blind plugs / Blind plugs in-situ

Ingold socket 25 mm G 1 1/4 for welding



bbi Scancode	BBI-44130024
Manufacturer	bbi-biotech GmbH
External Thread	G 1 1/4
Material Certificate	3.1, Rauigkeit
Country of Origin	DE 
Material	Stainless steel 316L

Components	1x Ingold socket
Related Products	Blind Plug 25 mm for G 1 1/4 (Ingold socket), length 40 mm (BBI-44130209) Blind plug 25 mm for G 1 1/4" (Ingold socket), standard length 52 mm (BBI-44130202) Probe adapter 25 mm for G 1 1/4 (Ingold socket) for 12 mm probes (BBI-44130106)
Description: <ul style="list-style-type: none"> • Counterpart for 25 mm Ingoldport accessories with G 1 1/4 thread • For welding to the tank 	



To the Shop:



Alle / Verkaufsartikel / Accessories / Blind plugs / Blind plugs in-situ

Sealing plug for standard 25 mm port G 1 1/4"



bbi Scancode	BBI-44130200
Manufacturer	bbi-biotech GmbH
Internal Thread	G 1 1/4
Material Certificate	3.1, Rauigkeit
Country of Origin	DE 
HS-Code	73269098
Material	Stainless steel 316L

Components	1x sealing plug
Related Products	Blind Plug 25mm for G 1 1/4" (Ingold socket), length 32 mm (BBI-44130216) Blind plug 25 mm for G 1 1/4" (Ingold socket), standard length 52 mm (BBI-44130202) Probe adapter 25 mm for G 1 1/4" (Ingold socket) for 12 mm probes (BBI-44130106)
Description: <ul style="list-style-type: none"> • For straight 25 mm threaded ports • Used e.g. in old Schering bioreactors • Accessories for bioreactors 	



To the Shop:



Alle / Verkaufsartikel / Accessories / Blind plugs / Blind plugs in-situ

Blind plug 25 mm for G 1 1/4" (Ingold socket), standard length 52 mm



bbi Scancode	BBI-44130202
Manufacturer	bbi-biotech GmbH
Internal Thread	G 1 1/4
Material Certificate	3.1, Rauigkeit, FDA
Country of Origin	DE 
HS-Code	73269098
Weight	0.3 kg
Material	Stainless steel 316L EPDM black

Components	1x blind plug, 1x coupling nut [BBI-44130011], 1x o-ring [BBI-45100014]
Consumables	O-ring for items to install in 25 mm Ingold ports (package of 10 pieces) (BBI-45100014) Circlips for items to install in 25 mm Ingold ports (package of 10 pieces) (BBI-45110301)
Related Products	Blind Plug 25 mm for G 1 1/4 (Ingold socket), length 30 mm (BBI-44130218) Blind Plug 25 mm for G 1 1/4 (Ingold socket), length 40 mm (BBI-44130209) Blind Plug 25 mm for G 1 1/4 (Ingold socket), length 67 mm (BBI-44130213)

Description:

- Blind plug 25 mm complete (with O-ring)
- For Ingold coupling with length 52 mm
- For in-situ vessels
- Spare part for fermenter or bioreactor



Alle / Verkaufsartikel / Accessories / Blind plugs / Blind plugs in-situ

Blind plug for 19 mm B.Braun Safety Side Port (Ingold socket)



bbi Scancode	BBI-44130204
Manufacturer	bbi-biotech GmbH
Internal Thread	Rd 28 x 1/8
Material Certificate	3.1, Rauigkeit, FDA
Country of Origin	DE 
HS-Code	73269098
Material	Stainless steel 316L EPDM black

Components	1x probe adapter; 1x coupling nut with circlip; 1x o-ring
Related Products	Blind Plug 25 mm for G 1 1/4" (Ingold socket), length 40 mm (BBI-44130209) Blind plug 25 mm for G 1 1/4" (Ingold socket), standard length 52 mm (BBI-44130202) Blind plug for 19 mm B.Braun Safety Side Port (Ingold socket), L = 30 mm (BBI-44130219)
<p>Description:</p> <ul style="list-style-type: none"> • For all 19 mm Ingold ports • Complete with o-ring • Length = 54 mm • Spare part for fermenter or bioreactor 	



Alle / Verkaufsartikel / Accessories / Blind plugs / Blind plugs in-situ

Blind plug Rd 28 × 1/8



bbi Scancode	BBI-44130205
Manufacturer	bbi-biotech GmbH
External Thread	Rd 28 × 1/8
Material Certificate	3.1, Rauigkeit, FDA
Country of Origin	DE 
HS-Code	73269098
Weight	0.13 kg
Material	Stainless steel 316L EPDM black

Components	1x blind plug, 1x o-ring [BBI-45100013]
Consumables	O-ring for items to install in Rd 28 × 1/8 ports (package of 10 pieces) (BBI-45100013)
Related Products	Adapter Rd 28 × 1/8 to M 26 × 1 (BBI-44130112) Adapter for 6 mm level probes or dip tubes for harvesting in Rd 28 × 1/8 ports (BBI-44630102) Membrane Holder Rd 28 × 1/8 (BBI-44130005)
<p>Description:</p> <ul style="list-style-type: none"> • Blind plug 19 mm complete (with O-ring) for Rd 28 × 1/8 ports • Spare part for fermenter and bioreactor 	



Alle / Verkaufsartikel / Accessories / Blind plugs / Blind plugs in-situ

Blind Plug 25 mm for G 1 ¼ (Ingold socket), length 40 mm



bbi Scancode	BBI-44130209
Manufacturer	bbi-biotech GmbH
Internal Thread	G 1 ¼
Material Certificate	3.1, Rauigkeit, FDA
Country of Origin	DE 
HS-Code	73269098
Weight	0.46 kg
Material	Stainless steel 316L EPDM black

Components	1x blind plug, 1x coupling nut [BBI-44130011], 1x o-ring [BBI-45100014]
Consumables	Circlips for items to install in 25 mm Ingold ports (package of 10 pieces) (BBI-45110301) O-ring for items to install in 25 mm Ingold ports (package of 10 pieces) (BBI-45100014)
Related Products	Blind Plug 25 mm for G 1 ¼ (Ingold socket), length 30 mm (BBI-44130218) Blind Plug 25 mm for G 1 ¼ (Ingold socket), length 67 mm (BBI-44130213) Blind plug 25 mm for G 1 ¼" (Ingold socket), standard length 52 mm (BBI-44130202)

Description:

- Blind plug 25 mm complete (with O-ring)
- For Ingold coupling with length 40 mm
- For in-situ vessels
- Spare part for fermenter or bioreactor



Alle / Verkaufsartikel / Accessories / Blind plugs / Blind plugs in-situ

Blind plug for 11 mm ports M 10 x 1 (for in-situ lids)



bbi Scancode	BBI-44130212
Manufacturer	bbi-biotech GmbH
External Thread	M 10 x 1
Material Certificate	3.1, Rauigkeit, FDA
Country of Origin	DE 
HS-Code	73269098
Weight	0.02 kg
Material	Stainless steel 316L EPDM black

Components	1x blind plug, 1x coupling nut flat [BBI-44130009], 1x O-ring [BBI-45100011]
Consumables	O-ring for items to install in 11 mm ports (package of 10 pieces) (BBI-45100011)
Related Products	Adapter for 6 mm level probes or dip tubes for harvesting in 11 mm ports (long) (BBI-44630104) Blind plug 25 mm for G 1 1/4" (Ingold socket), standard length 52 mm (BBI-44130202) Blind plug Rd 28 x 1/8 (BBI-44130205)

Description:

- Blind plugs for 11 mm ports long
- Long version for for 19.05 mm lid
- For use with in-situ bioreactors
- Spare part for fermentors



To the Shop:



Alle / Verkaufsartikel / Accessories / Blind plugs / Blind plugs in-situ

Blind Plug 25 mm for G 1 1/4 (Ingold socket), length 67 mm



bbi Scancode	BBI-44130213
Manufacturer	bbi-biotech GmbH
Internal Thread	G 1 1/4
Material Certificate	3.1, Rauigkeit, FDA
Country of Origin	DE 
HS-Code	73269098
Weight	0.56 kg
Material	Stainless steel 316L EPDM black

Components	1x blind plug, 1x coupling nut [BBI-44130011], 1x o-ring [BBI-45100014]
Consumables	Circlips for items to install in 25 mm Ingold ports (package of 10 pieces) (BBI-45110301) O-ring for items to install in 25 mm Ingold ports (package of 10 pieces) (BBI-45100014)
Related Products	Blind Plug 25 mm for G 1 1/4 (Ingold socket), length 30 mm (BBI-44130218) Blind Plug 25 mm for G 1 1/4 (Ingold socket), length 40 mm (BBI-44130209) Blind plug 25 mm for G 1 1/4" (Ingold socket), standard length 52 mm (BBI-44130202)

Description:

- Blind plug 25 mm complete (with O-ring)
- For Ingold coupling with length 67 mm
- For in-situ vessels
- Spare part for fermenter or bioreactor



Alle / Verkaufsartikel / Accessories / Blind plugs / Blind plugs in-situ

Blind Plug 25mm for G 1 1/4 (Ingold socket), length 32 mm



bbi Scancode	BBI-44130216
Manufacturer	bbi-biotech GmbH
Internal Thread	G 1 1/4
Material Certificate	3.1, Rauigkeit, FDA
Country of Origin	DE 
HS-Code	73269098
Weight	495.0 kg
Material	Stainless steel 316L EPDM black

Components	1x blind plug, 1x coupling nut [BBI-44130011], 1x o-ring [BBI-45100014]
Related Products	Blind Plug 25 mm for G 1 1/4 (Ingold socket), length 30 mm (BBI-44130218) Blind Plug 25 mm for G 1 1/4 (Ingold socket), length 40 mm (BBI-44130209) Blind plug 25 mm for G 1 1/4" (Ingold socket), standard length 52 mm (BBI-44130202)
<p>Description:</p> <ul style="list-style-type: none"> • Blind plug 25 mm complete (with O-ring) • For Ingold coupling with length 32 mm • For in-situ vessels • Spare part for fermenter or bioreactor 	



Alle / Verkaufsartikel / Accessories / Blind plugs / Blind plugs in-situ

Blind Plug 25 mm for G 1 ¼ (Ingold socket), length 30 mm



bbi Scancode	BBI-44130218
Manufacturer	bbi-biotech GmbH
Internal Thread	G 1 ¼
Material Certificate	3.1, Rauigkeit, FDA
Country of Origin	DE 
HS-Code	73269098
Material	Stainless steel 316L EPDM black

Components	1x blind plug, 1x coupling nut [BBI-44130011], 1x o-ring [BBI-45100014]
Related Products	Blind Plug 25 mm for G 1 ¼ (Ingold socket), length 40 mm (BBI-44130209) Blind Plug 25mm for G 1 ¼ (Ingold socket), length 32 mm (BBI-44130216) Blind plug 25 mm for G 1 ¼" (Ingold socket), standard length 52 mm (BBI-44130202)
Description: <ul style="list-style-type: none"> • Blind plug 25 mm complete (with O-ring) • For Ingold coupling with length 30 mm • For in-situ vessels • Spare part for fermenter or bioreactor 	



To the Shop:



Alle / Verkaufsartikel / Accessories / Blind plugs / Blind plugs in-situ

Blind plug for 19 mm B.Braun Safety Side Port (Ingold socket), L = 30 mm



bbi Scancode	BBI-44130219
Manufacturer	bbi-biotech GmbH
Internal Thread	Rd 28 x 1/8
Material Certificate	3.1, Rauigkeit, FDA
Country of Origin	DE 
HS-Code	73269098
Material	Stainless steel 316L EPDM black

Components	1x probe adapter; 1x coupling nut with circlip; 1x o-ring
Related Products	Blind Plug 25 mm for G 1 ¼ (Ingold socket), length 67 mm (BBI-44130213) Blind Plug 25mm for G 1 ¼ (Ingold socket), length 32 mm (BBI-44130216) Blind plug for 19 mm B.Braun Safety Side Port (Ingold socket) (BBI-44130204)

Description:

- For all 19 mm Ingold ports
- Complete with o-ring
- Length = 30 mm
- Spare part for fermenter or bioreactor



Alle / Verkaufsartikel / Accessories / Blind plugs / Blind plugs in-situ

Blind plug TC 25, l = 12.7 mm



bbi Scancode	BBI-44130220
Manufacturer	bbi-biotech GmbH
Material Certificate	3.1, Rauigkeit, FDA
Country of Origin	DE 
Material	Stainless steel 316L EPDM black

Components	1x blind plug, 1x o-ring, 1x flat gasket, 1x clamp
Related Products	Blind Plug 25 mm for G 1 1/4 (Ingold socket), length 30 mm (BBI-44130218) Blind plug TC 50.5, l = 21.5 mm (BBI-44130221) Blind plug TC 50.5, l = 39 mm (BBI-44130222)
Description:	



To the Shop:



Alle / Verkaufsartikel / Accessories / Blind plugs / Blind plugs in-situ

Blind plug TC 50.5, l = 21.5 mm



bbi Scancode	BBI-44130221
Manufacturer	bbi-biotech GmbH
Material Certificate	3.1, Rauigkeit, FDA
Country of Origin	DE 
Material	Stainless steel 316L EPDM black

Components	1x blind plug, 1x o-ring, 1x flat gasket, 1x clamp
Related Products	Blind Plug 25 mm for G 1 1/4 (Ingold socket), length 40 mm (BBI-44130209) Blind plug TC 25, l = 12.7 mm (BBI-44130220) Blind plug TC 50.5, l = 39 mm (BBI-44130222)
Description:	



Alle / Verkaufsartikel / Accessories / Blind plugs / Blind plugs in-situ

Blind plug TC 50.5, l = 39 mm



bbi Scancode	BBI-44130222
Manufacturer	bbi-biotech GmbH
Material Certificate	3.1, Rauigkeit, FDA
Country of Origin	DE 
Material	Stainless steel 316L EPDM black

Components	1x blind plug, 1x o-ring, 1x flat gasket, 1x clamp
Related Products	Blind Plug 25 mm for G 1 1/4 (Ingold socket), length 67 mm (BBI-44130213) Blind plug TC 25, l = 12.7 mm (BBI-44130220) Blind plug TC 50.5, l = 21.5 mm (BBI-44130221)
Description:	



To the Shop:



Alle / Verkaufsartikel / Accessories / Blind plugs / Blind plugs in-situ

Tri-Clamp lid 25 mm with seal and clamp



bbi Scancode	BBI-44130223
Material Certificate	3.1, Rauigkeit, FDA
Material	Stainless steel 316L

Components	1x lid; 1x seal; 1x clamp
Related Products	Headpiece for aerosolfree sampling with Tri-clamp (BBI-44130408) Sampling Valve SPN25 automated (standard) (BBI-43830202) Sampling Valve SPN25, manual (BBI-43830200)
Description:	



To the Shop:



Alle / Verkaufsartikel / Accessories / Harvesting / Bottom drain valves

Bottom drain valve SPN65, 270°, TC25, Naue DN6 Rd steam connection



bbi Scancode	BBI-43830210
Manufacturer	bbi-biotech GmbH
Material Certificate	3.1, Rauigkeit, FDA
Country of Origin	DE 
HS-Code	73269098
Weight	1.07 kg

Components	
Related Products	Bottom drain valve SPN65, 130°, TC25, steam connection variable (BBI-43830211) Bottom drain valve SPN65, 130°, TC34, steam connection variable (BBI-43830212)
Description: <ul style="list-style-type: none"> • For draining or harvesting fluids from bioreactors • Mounted in side port • Flange with BC = 65 mm • With triclamp 25 mm • Manual handling, automation optional • Also used for sampling 	



To the Shop:



Alle / Verkaufsartikel / Accessories / Harvesting / Bottom drain valves

Bottom drain valve SPN65, 130°, TC25, steam connection variable



bbi Scancode	BBI-43830211
Manufacturer	bbi-biotech GmbH
Material Certificate	3.1, Rauigkeit, FDA
Country of Origin	DE 
HS-Code	73269098

Components	
Related Products	Bottom drain valve SPN65, 130°, TC34, steam connection variable (BBI-43830212) Bottom drain valve SPN65, 270°, TC25, Naue DN6 Rd steam connection (BBI-43830210)
Description:	



To the Shop:



Alle / Verkaufsartikel / Accessories / Harvesting / Bottom drain valves

Bottom drain valve SPN65, 130°, TC34, steam connection variable



bbi Scancode	BBI-43830212
Manufacturer	bbi-biotech GmbH
Material Certificate	3.1, Rauigkeit, FDA
Country of Origin	DE 
HS-Code	73269098

Components	
Related Products	<p>Bottom drain valve SPN65, 130°, TC25, steam connection variable (BBI-43830211)</p> <p>Bottom drain valve SPN65, 270°, TC25, Naue DN6 Rd steam connection (BBI-43830210)</p>
Description:	



Alle / Verkaufsartikel / Accessories / Harvesting / Harvest pipes

5 L dip tube for harvesting, fix, ID = 4 mm, M 10 x 1



bbi Scancode	BBI-43630005
Manufacturer	bbi-biotech GmbH
External Thread	M 10 x 1
Installation Depth	311 mm
Material Certificate	3.1, Rauigkeit, FDA
Country of Origin	DE 
HS-Code	73269098
Weight	0.06 kg
Material	Stainless steel 316L EPDM black

Components	1x dip tube; 1x o-ring [BBI-45100011]; 1x coupling nut M10x1 [BBI-44130009]
Consumables	Coupling nut M 10 x 1 (flat) (BBI-44130009) O-ring for items to install in 11 mm ports (package of 10 pieces) (BBI-45100011)
Related Products	5 L dip tube for harvesting, fix, ID = 8 mm, Pg 13,5 (BBI-43630017) 5 L dip tube for harvesting, fix, with baffle, ID = 4 mm, M 10 x 1 (BBI-43630064) 5 L dip tube for harvesting, height-adjustable, ID = 4 mm, with adapter M 10 x 1 (BBI-43630033)

Description:

- For sterile harvesting of culture fluids from bioreactors and fermenters
- The length is matched to the culture vessel
- Mounted in headplate
- The media is taken from a fixed depth
- Also used for sampling and adding media
- Straight version
- With hose olive for hose with Di = 3.2 mm
- Spare part for bioreactors



To the Shop:



Alle / Verkaufsartikel / Accessories / Harvesting / Harvest pipes

Harvesting port with harvesting tube 8 mm



bbi Scancode	BBI-43630006
Manufacturer	bbi-biotech GmbH
External Thread	Rd 28 x 1/8
Material Certificate	3.1, Rauigkeit, FDA
Country of Origin	DE 
HS-Code	73269098
Material	Stainless steel 316L EPDM black

Components	1x harvesting port with tube, 1x o-ring [BBI-45100013]; 1x o-ring [BBI-45100011]
Consumables	Coupling nut M 10 x 1 (flat) (BBI-44130009) O-ring for items to install in 11 mm ports (package of 10 pieces) (BBI-45100011)
Related Products	Blind plug Rd 28 x 1/8 (BBI-44130205) Harvest port 6 mm (BBI-43630050) Harvest port 8 mm (BBI-43630051)

Description:

- For harvesting or adding media
- Length variable
- For installation in bioreactor lid
- For use with long inoculation needles, membrane and membrane holder
- For in-situ bioreactors
- Harvesting tube 12 x 1 for use with 8 mm addition port
- Spare part for bioreactors



Alle / Verkaufsartikel / Accessories / Harvesting / Harvest pipes

2 L dip tube for harvesting, fix, ID = 4 mm, M 10 x 1



bbi Scancode	BBI-43630012
Manufacturer	bbi-biotech GmbH
External Thread	M 10 x 1
Installation Depth	215 mm
Material Certificate	3.1, Rauigkeit, FDA
Country of Origin	DE 
HS-Code	73269098
Weight	0.05 kg
Material	Stainless steel 316L EPDM black

Components	1x dip tube; 1x o-ring [BBI-45100011]; 1x coupling nut M10x1 [BBI-44130009]
Consumables	Coupling nut M 10 x 1 (flat) (BBI-44130009) O-ring for items to install in 11 mm ports (package of 10 pieces) (BBI-45100011)
Related Products	2 L dip tube for harvesting, fix, ID = 8 mm, Pg 13,5 (BBI-43630016) 2 L dip tube for harvesting, fix, angled, ID = 4 mm, M 10 x 1 (BBI-43630047) 2 L dip tube for harvesting, height-adjustable, ID = 4 mm, with adapter M 10 x 1 (BBI-43630032)

Description:

- For sterile harvesting of culture fluids from bioreactors and fermenters
- The length is matched to the culture vessel
- Mounted in headplate
- The media is taken from a fixed depth
- Also used for sampling and adding media
- Straight version
- With hose olive for hose with Di = 3.2 mm
- Spare part for bioreactors



Alle / Verkaufsartikel / Accessories / Harvesting / Harvest pipes

1 L dip tube for harvesting, fix, ID = 4 mm, M 10 x 1



bbi Scancode	BBI-43630013
Manufacturer	bbi-biotech GmbH
External Thread	M 10 x 1
Installation Depth	154 mm
Material Certificate	3.1, Rauigkeit, FDA
Country of Origin	DE 
HS-Code	73269098
Weight	0.04 kg
Material	Stainless steel 316L EPDM black

Components	1x dip tube; 1x o-ring [BBI-45100011]; 1x coupling nut M10x1 [BBI-44130009]
Consumables	Coupling nut M 10 x 1 (flat) (BBI-44130009) O-ring for items to install in 11 mm ports (package of 10 pieces) (BBI-45100011)
Related Products	1 L dip tube for harvesting, fix, ID = 8 mm, Pg 13,5 (BBI-43630015) 1 L dip tube for harvesting, height-adjustable, ID = 4 mm, with adapter M 10 x 1 (BBI-43630031) 1 L dip tube for harvesting, height-adjustable, ID = 4 mm, without adapter M 10 x 1 (BBI-43630036)

Description:

- For sterile harvesting of culture fluids from bioreactors and fermenters
- The length is matched to the culture vessel
- Mounted in headplate
- The media is taken from a fixed depth
- Also used for sampling and adding media
- Straight version
- With hose olive for hose with Di = 3.2 mm
- Spare part for bioreactors



To the Shop:



Alle / Verkaufsartikel / Accessories / Harvesting / Harvest pipes

10 L dip tube for harvesting, fix, ID = 4 mm, M 10 x 1



bbi Scancode	BBI-43630014
Manufacturer	bbi-biotech GmbH
External Thread	M 10 x 1
Installation Depth	424 mm
Material Certificate	3.1, Rauigkeit, FDA
Country of Origin	DE 
HS-Code	73269098
Weight	0.08 kg
Material	Stainless steel 316L EPDM black

Components	1x dip tube; 1x o-ring [BBI-45100011]; 1x coupling nut M10x1 [BBI-44130009]
Consumables	Coupling nut M 10 x 1 (flat) (BBI-44130009) O-ring for items to install in 11 mm ports (package of 10 pieces) (BBI-45100011)

Description:

- For sterile harvesting of culture fluids from bioreactors and fermenters
- The length is matched to the culture vessel
- Mounted in headplate
- The media is taken from a fixed depth
- Also used for sampling and adding media
- Straight version
- With hose olive for hose with Di = 3.2 mm
- Spare part for bioreactors



Alle / Verkaufsartikel / Accessories / Harvesting / Harvest pipes

1 L dip tube for harvesting, fix, ID = 8 mm, Pg 13,5



bbi Scancode	BBI-43630015
Manufacturer	bbi-biotech GmbH
External Thread	Pg 13,5
Installation Depth	156 mm
Material Certificate	3.1, Rauigkeit, FDA
Country of Origin	DE 
HS-Code	73269098
Weight	0.09 kg
Material	Stainless steel 316L EPDM black

Components	1x dip tube; 1x seal [BBI-44130214]
Consumables	Flat seal with hole for 12 mm ports (package of 5 pieces) (BBI-44130214)
Related Products	0.5 L dip tube for harvesting, fix, ID = 8 mm, Pg 13,5 (BBI-43630025) Harvest port 8 mm (BBI-43630051) Harvesting port with harvesting tube 8 mm (BBI-43630006)

Description:

- For sterile harvesting of culture fluids from bioreactors and fermenters
- The length is matched to the culture vessel
- Mounted in headplate
- The media is taken from a fixed depth
- Also used for sampling and adding media
- Straight version
- Spare part for bioreactors



Alle / Verkaufsartikel / Accessories / Harvesting / Harvest pipes

2 L dip tube for harvesting, fix, ID = 8 mm, Pg 13,5



bbi Scancode	BBI-43630016
Manufacturer	bbi-biotech GmbH
External Thread	Pg 13,5
Installation Depth	217 mm
Material Certificate	3.1, Rauigkeit, FDA
Country of Origin	DE 
HS-Code	73269098
Weight	0.05 kg
Material	Stainless steel 316L EPDM black

Components	1x dip tube; 1x seal [BBI-44130214]
Consumables	Flat seal with hole for 12 mm ports (package of 5 pieces) (BBI-44130214)
Related Products	2 L dip tube for harvesting, fix, ID = 4 mm, M 10 x 1 (BBI-43630012) 2 L dip tube for harvesting, height-adjustable, ID = 4 mm, with adapter M 10 x 1 (BBI-43630032) Flat seal with hole for 12 mm ports (package of 5 pieces) (BBI-44130214)

Description:

- For sterile harvesting of culture fluids from bioreactors and fermenters
- The length is matched to the culture vessel
- Mounted in headplate
- The media is taken from a fixed depth
- Also used for sampling and adding media
- Straight version
- Spare part for bioreactors



To the Shop:



Alle / Verkaufsartikel / Accessories / Harvesting / Harvest pipes

5 L dip tube for harvesting, fix, ID = 8 mm, Pg 13,5



bbi Scancode	BBI-43630017
Manufacturer	bbi-biotech GmbH
External Thread	Pg 13,5
Installation Depth	313 mm
Material Certificate	3.1, Rauigkeit, FDA
Country of Origin	DE 
HS-Code	73269098
Weight	0.06 kg
Material	Stainless steel 316L EPDM black

Components	1x dip tube; 1x seal [BBI-44130214]
Consumables	Flat seal with hole for 12 mm ports (package of 5 pieces) (BBI-44130214)
Related Products	5 L dip tube for harvesting, fix, ID = 4 mm, M 10 x 1 (BBI-43630005) 5 L dip tube for harvesting, fix, angled, ID = 4 mm, M 10 x 1 (BBI-43630048) 5 L dip tube for harvesting, height-adjustable, ID = 4 mm, with adapter M 10 x 1 (BBI-43630033)

Description:

- For sterile harvesting of culture fluids from bioreactors and fermenters
- The length is matched to the culture vessel
- Mounted in headplate
- The media is taken from a fixed depth
- Also used for sampling and adding media
- Straight version
- Spare part for bioreactors



To the Shop:



Alle / Verkaufsartikel / Accessories / Harvesting / Harvest pipes

10 L dip tube for harvesting, fix, ID = 8 mm, Pg 13,5



bbi Scancode	BBI-43630018
Manufacturer	bbi-biotech GmbH
External Thread	Pg 13,5
Installation Depth	426 mm
Material Certificate	3.1, Rauigkeit, FDA
Country of Origin	DE 
HS-Code	73269098
Weight	0.07 kg
Material	Stainless steel 316L EPDM black

Components	1x dip tube; 1x seal [BBI-44130214]
Consumables	Flat seal with hole for 12 mm ports (package of 5 pieces) (BBI-44130214)

Description:

- For sterile harvesting of culture fluids from bioreactors and fermenters
- The length is matched to the culture vessel
- Mounted in headplate
- The media is taken from a fixed depth
- Also used for sampling and adding media
- Straight version
- Spare part for bioreactors



To the Shop:



Alle / Verkaufsartikel / Accessories / Harvesting / Harvest pipes

1 L dip tube for harvesting, fix, ID = 2 mm, M 10 x 1



bbi Scancode	BBI-43630019
Manufacturer	bbi-biotech GmbH
External Thread	M 10 x 1
Installation Depth	154 mm
Material Certificate	3.1, Rauigkeit, FDA
Country of Origin	DE 
HS-Code	73269098
Weight	0.04 kg
Material	Stainless steel 316L EPDM black

Components	1x dip tube; 1x o-ring [BBI-45100011]; 1x coupling nut M10x1 [BBI-44130009]
Related Products	<p>1 L dip tube for harvesting, fix, ID = 4 mm, M 10 x 1 (BBI-43630013)</p> <p>1 L dip tube for harvesting, fix, ID = 8 mm, Pg 13,5 (BBI-43630015)</p> <p>1 L dip tube for harvesting, height-adjustable, angled, ID = 4 mm, with adapter M 10 x 1 (BBI-43630041)</p>

Description:

- For sterile harvesting of culture fluids from bioreactors and fermenters
- The length is matched to the culture vessel
- Mounted in headplate
- The media is taken from a fixed depth
- Also used for sampling and adding media
- Straight version
- With hose olive for hose with Di = 1.6 mm



To the Shop:



Alle / Verkaufsartikel / Accessories / Harvesting / Harvest pipes

2 L dip tube for harvesting, fix, ID = 2 mm, M 10 x 1



bbi Scancode	BBI-43630020
Manufacturer	bbi-biotech GmbH
External Thread	M 10 x 1
Installation Depth	215 mm
Material Certificate	3.1, Rauigkeit, FDA
Country of Origin	DE 
HS-Code	73269098
Weight	0.05 kg
Material	Stainless steel 316L EPDM black

Components	1x dip tube; 1x o-ring [BBI-45100011]; 1x coupling nut M10x1 [BBI-44130009]
Consumables	O-ring for items to install in 11 mm ports (package of 10 pieces) (BBI-45100011) Coupling nut M 10 x 1 (flat) (BBI-44130009)
Related Products	2 L dip tube for harvesting, fix, ID = 4 mm, M 10 x 1 (BBI-43630012) 2 L dip tube for harvesting, fix, ID = 8 mm, Pg 13,5 (BBI-43630016) Blind plug M 10 x 1 (BBI-44130207)

Description:

- For sterile harvesting of culture fluids from bioreactors and fermenters
- The length is matched to the culture vessel
- Mounted in headplate
- The media is taken from a fixed depth
- Also used for sampling and adding media
- Straight version
- With hose olive for hose with Di = 1.6 mm



Alle / Verkaufsartikel / Accessories / Harvesting / Harvest pipes

5 L dip tube for harvesting, fix, ID = 2 mm, M 10 x 1



bbi Scancode	BBI-43630021
Manufacturer	bbi-biotech GmbH
External Thread	M 10 x 1
Installation Depth	311 mm
Material Certificate	3.1, Rauigkeit, FDA
Country of Origin	DE 
HS-Code	73269098
Weight	0.06 kg
Material	Stainless steel 316L EPDM black

Components	1x dip tube; 1x o-ring [BBI-45100011]; 1x coupling nut M10x1 [BBI-44130009]
Consumables	O-ring for items to install in 11 mm ports (package of 10 pieces) (BBI-45100011) Coupling nut M 10 x 1 (flat) (BBI-44130009)
Related Products	5 L dip tube for harvesting, fix, ID = 4 mm, M 10 x 1 (BBI-43630005) 5 L dip tube for harvesting, fix, ID = 8 mm, Pg 13,5 (BBI-43630017) 5 L dip tube for harvesting, height-adjustable, ID = 4 mm, with adapter M 10 x 1 (BBI-43630033)

Description:

- For sterile harvesting of culture fluids from bioreactors and fermenters
- The length is matched to the culture vessel
- Mounted in headplate
- The media is taken from a fixed depth
- Also used for sampling and adding media
- Straight version
- With hose olive for hose with Di = 1.6 mm



Alle / Verkaufsartikel / Accessories / Harvesting / Harvest pipes

10 L dip tube for harvesting, fix, ID = 2 mm, M 10 x 1



bbi Scancode	BBI-43630022
Manufacturer	bbi-biotech GmbH
External Thread	M 10 x 1
Installation Depth	424 mm
Material Certificate	3.1, Rauigkeit, FDA
Country of Origin	DE 
HS-Code	73269098
Weight	0.07 kg
Material	Stainless steel 316L EPDM black

Components	1x dip tube; 1x o-ring [BBI-45100011]; 1x coupling nut M10x1 [BBI-44130009]
Consumables	O-ring for items to install in 11 mm ports (package of 10 pieces) (BBI-45100011) Coupling nut M 10 x 1 (flat) (BBI-44130009)

Description:

- For sterile harvesting of culture fluids from bioreactors and fermenters
- The length is matched to the culture vessel
- Mounted in headplate
- The media is taken from a fixed depth
- Also used for sampling and adding media
- Straight version
- With hose olive for hose with Di = 1.6 mm



Alle / Verkaufsartikel / Accessories / Harvesting / Harvest pipes

0.5 L dip tube for harvesting, fix, ID = 4 mm, M 10 x 1



bbi Scancode	BBI-43630023
Manufacturer	bbi-biotech GmbH
External Thread	M 10 x 1
Installation Depth	118 mm
Material Certificate	3.1, Rauigkeit, FDA
Country of Origin	DE 
HS-Code	73269098
Weight	0.03 kg
Material	Stainless steel 316L EPDM black

Components	1x dip tube; 1x o-ring [BBI-45100011]; 1x coupling nut M10x1 [BBI-44130009]
Consumables	O-ring for items to install in 11 mm ports (package of 10 pieces) (BBI-45100011) Coupling nut M 10 x 1 (flat) (BBI-44130009)
Related Products	0,5 L dip tube for harvesting, fix, with baffle, ID = 4 mm, M 10 x 1 (BBI-43630061) 0.5 L dip tube for harvesting, fix, ID = 2 mm, M 10 x 1 (BBI-43630024) 0.5 L dip tube for harvesting, fix, ID = 8 mm, Pg 13,5 (BBI-43630025)

Description:

- For sterile harvesting of culture fluids from bioreactors and fermenters
- The length is matched to the culture vessel
- Mounted in headplate
- The media is taken from a fixed depth
- Also used for sampling and adding media
- Straight version
- With hose olive for hose with Di = 3.2 mm



To the Shop:



Alle / Verkaufsartikel / Accessories / Harvesting / Harvest pipes

0.5 L dip tube for harvesting, fix, ID = 2 mm, M 10 x 1



bbi Scancode	BBI-43630024
Manufacturer	bbi-biotech GmbH
External Thread	M 10 x 1
Installation Depth	118 mm
Material Certificate	3.1, Rauigkeit, FDA
Country of Origin	DE 
HS-Code	73269098
Weight	0.03 kg
Material	Stainless steel 316L EPDM black

Components	1x dip tube; 1x o-ring [BBI-45100011]; 1x coupling nut M10x1 [BBI-44130009]
Consumables	O-ring for items to install in 11 mm ports (package of 10 pieces) (BBI-45100011) Coupling nut M 10 x 1 (flat) (BBI-44130009)
Related Products	0.5 L Pt100 casing (BBI-43430007) 0.5 L dip tube for harvesting, fix, ID = 4 mm, M 10 x 1 (BBI-43630023) 0.5 L dip tube for harvesting, fix, angled, ID = 4 mm, M 10 x 1 (BBI-43630045)

Description:

- For sterile harvesting of culture fluids from bioreactors and fermenters
- The length is matched to the culture vessel
- Mounted in headplate
- The media is taken from a fixed depth
- Also used for sampling and adding media
- Straight version
- With hose olive for hose with Di = 1.6 mm



To the Shop:



Alle / Verkaufsartikel / Accessories / Harvesting / Harvest pipes

0.5 L dip tube for harvesting, fix, ID = 8 mm, Pg 13,5



bbi Scancode	BBI-43630025
Manufacturer	bbi-biotech GmbH
External Thread	Pg 13,5
Material Certificate	3.1, Rauigkeit, FDA
Country of Origin	DE 
HS-Code	73269098
Weight	0.08 kg
Material	Stainless steel 316L EPDM black

Components	1x dip tube; 1x seal [BBI-44130214]
Consumables	Flat seal with hole for 12 mm ports (package of 5 pieces) (BBI-44130214)
Related Products	0,5 L dip tube for harvesting, fix, with baffle, ID = 4 mm, M 10 x 1 (BBI-43630061) 0.5 L dip tube for harvesting, fix, ID = 4 mm, M 10 x 1 (BBI-43630023) 0.5 L dip tube for harvesting, fix, angled, ID = 4 mm, M 10 x 1 (BBI-43630045)

Description:

- For sterile harvesting of culture fluids from bioreactors and fermenters
- The length is matched to the culture vessel
- Mounted in headplate
- The media is taken from a fixed depth
- Also used for sampling and adding media
- Straight version
- Spare part for bioreactors



Alle / Verkaufsartikel / Accessories / Harvesting / Harvest pipes

0,25 L dip tube for harvesting, fix, ID = 4 mm



bbi Scancode	BBI-43630026
Manufacturer	bbi-biotech GmbH
Material Certificate	3.1, Rauigkeit, FDA
Weight	0.03 kg
Material	Stainless steel 316L

Components	1x dip tube
Related Products	0,25 L Pt100 sleeve (BBI-43430000) 0,25 L lid (BBI-44430352) 0.25 L jacketed glass vessel (BBI-44430054)

Description:

- For sterile harvesting of culture fluids from bioreactors and fermenters
- The length is matched to the culture vessel
- For welding to the headplate
- The media is taken from a fixed depth
- Also used for sampling and adding media
- Straight version
- With hose olive for hose with Di = 3.2 mm
- Spare part for bioreactors



Alle / Verkaufsartikel / Accessories / Harvesting / Harvest pipes

0.25 L dip tube for harvesting, height-adjustable, ID = 4 mm, without adapter



bbi Scancode	BBI-43630028
Manufacturer	bbi-biotech GmbH
Material Certificate	3.1, Rauigkeit, FDA
Country of Origin	DE 
Material	Stainless steel 316L

Components	1x dip tube, 1x circlip [BBI-45110302]
Related Products	0,25 L dip tube for harvesting, fix, ID = 4 mm (BBI-43630026) 0,25 L dip tube for harvesting, fix, with baffle, ID = 4 mm, M 10 x 1 (BBI-43630060) 0,25 L lid (BBI-44430352)

Description:

- For Harvesting fluids from bioreactors
- Mounted in headplate
- Also used for sampling and adding media
- The installation depth is variable with the supplied adapter
- Installation port: M 10 x 1
- Straight version, height-adjustable
- With hose olive for hose with Di = 3.2 mm



Alle / Verkaufsartikel / Accessories / Harvesting / Harvest pipes

0.5 L dip tube for harvesting, height-adjustable, ID = 4 mm, with adapter M 10 x 1



bbi Scancode	BBI-43630030
Manufacturer	bbi-biotech GmbH
External Thread	M 10 x 1
Material Certificate	3.1, Rauigkeit, FDA
Country of Origin	DE 
HS-Code	73269098
Material	Stainless steel 316L EPDM black PTFE

Components	1x dip tube, 1x circlip [BBI-45110302]; 1x adapter [BBI-44630103]
Consumables	Coupling nut M 10 x 1 (high) (BBI-44130010) Coupling nut M 10 x 1 (flat) (BBI-44130009) O-ring for items to install in 11 mm ports (package of 10 pieces) (BBI-45100011) O-ring for adapter (package of 5 pieces) (BBI-45100025) Clamping cone (Package of 5 pieces) (BBI-44130017) Circlip for dip tube for harvesting, height-adjustable (package of 10 pieces) (BBI-45110302)
Related Products	0,5 L dip tube for harvesting, fix, with baffle, ID = 4 mm, M 10 x 1 (BBI-43630061) 0.5 L dip tube for harvesting, fix, ID = 4 mm, M 10 x 1 (BBI-43630023) Adapter for 6 mm level probes or dip tubes for harvesting in 11 mm ports (BBI-44630103)

Description:

- For Harvesting fluids from bioreactors
- Mounted in headplate
- Also used for sampling and adding media
- The installation depth is variable with the supplied adapter
- Installation port: M 10 x 1
- Straight version, height-adjustable
- With hose olive for hose with Di = 3.2 mm
- Total length = 168 mm



To the Shop:



Alle / Verkaufsartikel / Accessories / Harvesting / Harvest pipes

1 L dip tube for harvesting, height-adjustable, ID = 4 mm, with adapter M 10 x 1



bbi Scancode	BBI-43630031
Manufacturer	bbi-biotech GmbH
External Thread	M 10 x 1
Material Certificate	3.1, Rauigkeit, FDA
Country of Origin	DE 
HS-Code	73269098
Weight	0.05 kg
Material	Stainless steel 316L EPDM black PTFE

Components	1x dip tube, 1x circlip [BBI-45110302]; 1x adapter [BBI-44630103]
Consumables	Coupling nut M 10 x 1 (high) (BBI-44130010) Coupling nut M 10 x 1 (flat) (BBI-44130009) O-ring for items to install in 11 mm ports (package of 10 pieces) (BBI-45100011) O-ring for adapter (package of 5 pieces) (BBI-45100025) Clamping cone (Package of 5 pieces) (BBI-44130017) Circlip for dip tube for harvesting, height-adjustable (package of 10 pieces) (BBI-45110302)
Related Products	1 L dip tube for harvesting, height-adjustable, ID = 4 mm, without adapter M 10 x 1 (BBI-43630036) 1 L lid (BBI-44430012) Adapter for 6 mm level probes or dip tubes for harvesting in 11 mm ports (BBI-44630103)

Description:

- For Harvesting fluids from bioreactors
- Mounted in headplate
- Also used for sampling and adding media
- The installation depth is variable with the supplied adapter
- Installation port: M 10 x 1
- Straight version, height-adjustable
- With hose olive for hose with Di = 3.2 mm
- Total length = 204 mm



To the Shop:



Alle / Verkaufsartikel / Accessories / Harvesting / Harvest pipes

2 L dip tube for harvesting, height-adjustable, ID = 4 mm, with adapter M 10 x 1



bbi Scancode	BBI-43630032
Manufacturer	bbi-biotech GmbH
External Thread	M 10 x 1
Material Certificate	3.1, Rauigkeit, FDA
Country of Origin	DE 
HS-Code	73269098
Material	Stainless steel 316L EPDM black PTFE

Components	1x dip tube, 1x circlip [BBI-45110302]; 1x adapter [BBI-44630103]
Consumables	Coupling nut M 10 x 1 (high) (BBI-44130010) Coupling nut M 10 x 1 (flat) (BBI-44130009) O-ring for items to install in 11 mm ports (package of 10 pieces) (BBI-45100011) Circlip for dip tube for harvesting, height-adjustable (package of 10 pieces) (BBI-45110302) O-ring for adapter (package of 5 pieces) (BBI-45100025) Clamping cone (Package of 5 pieces) (BBI-44130017)
Related Products	2 L dip tube for harvesting, fix, ID = 4 mm, M 10 x 1 (BBI-43630012) 2 L dip tube for harvesting, height-adjustable, ID = 4 mm, without adapter (BBI-43630037) Adapter for 6 mm level probes or dip tubes for harvesting in 11 mm ports (BBI-44630103)

Description:

- For Harvesting fluids from bioreactors
- Mounted in headplate
- Also used for sampling and adding media
- The installation depth is variable with the supplied adapter
- Installation port: M 10 x 1
- Straight version, height-adjustable
- With hose olive for hose with Di = 3.2 mm
- Total length = 264 mm



To the Shop:



Alle / Verkaufsartikel / Accessories / Harvesting / Harvest pipes

5 L dip tube for harvesting, height-adjustable, ID = 4 mm, with adapter M 10 x 1



bbi Scancode	BBI-43630033
Manufacturer	bbi-biotech GmbH
External Thread	M 10 x 1
Material Certificate	3.1, Rauigkeit, FDA
Country of Origin	DE 
HS-Code	73269098
Material	Stainless steel 316L EPDM black PTFE

Components	1x dip tube, 1x circlip [BBI-45110302]; 1x adapter [BBI-44630103]
Consumables	Coupling nut M 10 x 1 (high) (BBI-44130010) Coupling nut M 10 x 1 (flat) (BBI-44130009) O-ring for items to install in 11 mm ports (package of 10 pieces) (BBI-45100011) Circlip for dip tube for harvesting, height-adjustable (package of 10 pieces) (BBI-45110302) O-ring for adapter (package of 5 pieces) (BBI-45100025) Clamping cone (Package of 5 pieces) (BBI-44130017)
Related Products	5 L dip tube for harvesting, fix, ID = 4 mm, M 10 x 1 (BBI-43630005) 5 L dip tube for harvesting, fix, ID = 8 mm, Pg 13,5 (BBI-43630017) 5 L dip tube for harvesting, height-adjustable, ID = 4 mm, without adapter M 10 x 1 (BBI-43630038)

Description:

- For Harvesting fluids from bioreactors
- Mounted in headplate
- Also used for sampling and adding media
- The installation depth is variable with the supplied adapter
- Installation port: M 10 x 1
- Straight version, height-adjustable
- With hose olive for hose with Di = 3.2 mm
- Total length = 360 mm



To the Shop:



Alle / Verkaufsartikel / Accessories / Harvesting / Harvest pipes

10 L dip tube for harvesting, height-adjustable, ID = 4 mm, with adapter M 10 x 1



bbi Scancode	BBI-43630034
Manufacturer	bbi-biotech GmbH
External Thread	M 10 x 1
Material Certificate	3.1, Rauigkeit, FDA
Country of Origin	DE 
HS-Code	73269098
Material	Stainless steel 316L EPDM black PTFE

Components	1x dip tube, 1x circlip [BBI-45110302]; 1x adapter [BBI-44630103]
Consumables	Coupling nut M 10 x 1 (high) (BBI-44130010) Coupling nut M 10 x 1 (flat) (BBI-44130009) O-ring for items to install in 11 mm ports (package of 10 pieces) (BBI-45100011) Circlip for dip tube for harvesting, height-adjustable (package of 10 pieces) (BBI-45110302) O-ring for adapter (package of 5 pieces) (BBI-45100025) Clamping cone (Package of 5 pieces) (BBI-44130017)
Description: <ul style="list-style-type: none"> • For Harvesting fluids from bioreactors • Mounted in headplate • Also used for sampling and adding media • The installation depth is variable with the supplied adapter • Installation port: M 10 x 1 • Straight version, height-adjustable • With hose olive for hose with Di = 3.2 mm • Total length = 474 mm 	



To the Shop:



Alle / Verkaufsartikel / Accessories / Harvesting / Harvest pipes

0.5 L dip tube for harvesting, height-adjustable, ID = 4 mm, without adapter M 10 x 1



bbi Scancode	BBI-43630035
Manufacturer	bbi-biotech GmbH
Material Certificate	3.1, Rauigkeit
Country of Origin	DE 
HS-Code	73269098
Weight	0.02 kg
Material	Stainless steel 316L EPDM black

Components	1x dip tube, 1x circlip [BBI-45110302]
Consumables	Circlip for dip tube for harvesting, height-adjustable (package of 10 pieces) (BBI-45110302)
Related Products	0.5 L dip tube for harvesting, fix, ID = 4 mm, M 10 x 1 (BBI-43630023) 0.5 L dip tube for harvesting, fix, angled, ID = 4 mm, M 10 x 1 (BBI-43630045) 0.5 L dip tube for harvesting, height-adjustable, ID = 4 mm, with adapter M 10 x 1 (BBI-43630030)

Description:

- For Harvesting fluids from bioreactors
- Mounted in headplate
- Also used for sampling and adding media
- Adapter [BBI-44630103] available separately
- Installation port: M 10 x 1
- Straight version, height-adjustable
- With hose olive for hose with Di = 3.2 mm
- Total length = 168 mm



To the Shop:



Alle / Verkaufsartikel / Accessories / Harvesting / Harvest pipes

1 L dip tube for harvesting, height-adjustable, ID = 4 mm, without adapter M 10 x 1



bbi Scancode	BBI-43630036
Manufacturer	bbi-biotech GmbH
Material Certificate	3.1, Rauigkeit
Country of Origin	DE 
HS-Code	73269098
Weight	0.03 kg
Material	Stainless steel 316L EPDM black

Components	1x dip tube, 1x circlip [BBI-45110302]
Consumables	Circlip for dip tube for harvesting, height-adjustable (package of 10 pieces) (BBI-45110302)
Related Products	1 L dip tube for harvesting, fix, ID = 4 mm, M 10 x 1 (BBI-43630013) 1 L dip tube for harvesting, fix, ID = 8 mm, Pg 13,5 (BBI-43630015) 1 L dip tube for harvesting, height-adjustable, ID = 4 mm, with adapter M 10 x 1 (BBI-43630031)

Description:

- For Harvesting fluids from bioreactors
- Mounted in headplate
- Also used for sampling and adding media
- Adapter [BBI-44630103] available separately
- Installation port: M 10 x 1
- Straight version, height-adjustable
- With hose olive for hose with Di = 3.2 mm
- Total length = 204 mm



To the Shop:



Alle / Verkaufsartikel / Accessories / Harvesting / Harvest pipes

2 L dip tube for harvesting, height-adjustable, ID = 4 mm, without adapter



bbi Scancode	BBI-43630037
Manufacturer	bbi-biotech GmbH
Material Certificate	3.1, Rauigkeit
Country of Origin	DE 
HS-Code	73269098
Weight	0.04 kg
Material	Stainless steel 316L EPDM black

Components	1x dip tube, 1x circlip [BBI-45110302]
Consumables	2 L dip tube for harvesting, height-adjustable, ID = 4 mm, without adapter (BBI-43630037)
Related Products	2 L dip tube for harvesting, fix, ID = 4 mm, M 10 x 1 (BBI-43630012) 2 L dip tube for harvesting, height-adjustable, ID = 4 mm, with adapter M 10 x 1 (BBI-43630032) Adapter for 6 mm level probes or dip tubes for harvesting in 11 mm ports (BBI-44630103)

Description:

- For Harvesting fluids from bioreactors
- Mounted in headplate
- Also used for sampling and adding media
- Adapter [BBI-44630103] available separately
- Installation port: M 10 x 1
- Straight version, height-adjustable
- With hose olive for hose with Di = 3.2 mm
- Total length = 264 mm



Alle / Verkaufsartikel / Accessories / Harvesting / Harvest pipes

5 L dip tube for harvesting, height-adjustable, ID = 4 mm, without adapter M 10 x 1



bbi Scancode	BBI-43630038
Manufacturer	bbi-biotech GmbH
Material Certificate	3.1, Rauigkeit
Country of Origin	DE 
HS-Code	73269098
Weight	0.05 kg
Material	Stainless steel 316L EPDM black

Components	1x dip tube, 1x circlip [BBI-45110302]
Consumables	Circlip for dip tube for harvesting, height-adjustable (package of 10 pieces) (BBI-45110302)
Related Products	5 L dip tube for harvesting, fix, ID = 4 mm, M 10 x 1 (BBI-43630005) 5 L dip tube for harvesting, fix, ID = 8 mm, Pg 13,5 (BBI-43630017) 5 L dip tube for harvesting, height-adjustable, ID = 4 mm, with adapter M 10 x 1 (BBI-43630033)

Description:

- For Harvesting fluids from bioreactors
- Mounted in headplate
- Also used for sampling and adding media
- Adapter [BBI-44630103] available separately
- Installation port: M 10 x 1
- Straight version, height-adjustable
- With hose olive for hose with Di = 3.2 mm
- Total length = 360 mm



To the Shop:



Alle / Verkaufsartikel / Accessories / Harvesting / Harvest pipes

10 L dip tube for harvesting, height-adjustable, ID = 4 mm, without adapter M 10 x 1



bbi Scancode	BBI-43630039
Manufacturer	bbi-biotech GmbH
Material Certificate	3.1, Rauigkeit
Country of Origin	DE 
HS-Code	73269098
Weight	0.06 kg
Material	Stainless steel 316L EPDM black

Components	1x dip tube, 1x circlip [BBI-45110302]
Consumables	Circlip for dip tube for harvesting, height-adjustable (package of 10 pieces) (BBI-45110302)

Description:

- For Harvesting fluids from bioreactors
- Mounted in headplate
- Also used for sampling and adding media
- Adapter [BBI-44630103] available separately
- Installation port: M 10 x 1
- Straight version, height-adjustable
- With hose olive for hose with Di = 3.2 mm
- Total length = 474 mm



Alle / Verkaufsartikel / Accessories / Harvesting / Harvest pipes

0.5 L dip tube for harvesting, height-adjustable, angled, ID = 4 mm, with adapter M 10 x 1



bbi Scancode	BBI-43630040
Manufacturer	bbi-biotech GmbH
External Thread	M 10 x 1
Material Certificate	3.1, Rauigkeit, FDA
Country of Origin	DE 
HS-Code	73269098
Material	Stainless steel 316L EPDM black PTFE

Components	1x dip tube, 1x circlip [BBI-45110302], 1x clamp adapter [BBI-44630103]
Consumables	Coupling nut M 10 x 1 (high) (BBI-44130010) Coupling nut M 10 x 1 (flat) (BBI-44130009) O-ring for items to install in 11 mm ports (package of 10 pieces) (BBI-45100011) Circlip for dip tube for harvesting, height-adjustable (package of 10 pieces) (BBI-45110302) O-ring for adapter (package of 5 pieces) (BBI-45100025) Clamping cone (Package of 5 pieces) (BBI-44130017)
Related Products	10 L dip tube for harvesting, height-adjustable, angled, ID = 4 mm, with adapter M 10 x 1 (BBI-43630044) 2 L dip tube for harvesting, height-adjustable, angled, ID = 4 mm, with adapter M 10 x 1 (BBI-43630042) 5 L dip tube for harvesting, height-adjustable, angled, ID = 4 mm, with adapter M 10 x 1 (BBI-43630043)

Description:

- For Harvesting fluids from bioreactors
- Mounted in headplate
- Also used for sampling and adding media
- Variable installation depth with clamping adapter
- Installation port: M 10 x 1
- Angled version, height-adjustable
- With hose olive for hose with Di = 3.2 mm



To the Shop:



Alle / Verkaufsartikel / Accessories / Harvesting / Harvest pipes

1 L dip tube for harvesting, height-adjustable, angled, ID = 4 mm, with adapter M 10 x 1



bbi Scancode	BBI-43630041
Manufacturer	bbi-biotech GmbH
External Thread	M 10 x 1
Material Certificate	3.1, Rauigkeit, FDA
Country of Origin	DE 
HS-Code	73269098
Material	Stainless steel 316L EPDM black PTFE

Components	1x dip tube, 1x circlip [BBI-45110302], 1x clamp adapter [BBI-44630103]
Consumables	Coupling nut M 10 x 1 (high) (BBI-44130010) Coupling nut M 10 x 1 (flat) (BBI-44130009) O-ring for items to install in 11 mm ports (package of 10 pieces) (BBI-45100011) Circlip for dip tube for harvesting, height-adjustable (package of 10 pieces) (BBI-45110302) O-ring for adapter (package of 5 pieces) (BBI-45100025) Clamping cone (Package of 5 pieces) (BBI-44130017)
Related Products	1 L dip tube for harvesting, height-adjustable, ID = 4 mm, with adapter M 10 x 1 (BBI-43630031) 1 L dip tube for harvesting, height-adjustable, ID = 4 mm, without adapter M 10 x 1 (BBI-43630036) Adapter for 6 mm level probes or dip tubes for harvesting in 11 mm ports (BBI-44630103)

Description:

- For Harvesting fluids from bioreactors
- Mounted in headplate
- Also used for sampling and adding media
- Variable installation depth with clamping adapter
- Installation port: M 10 x 1
- Angled version, height-adjustable
- With hose olive for hose with Di = 3.2 mm



Alle / Verkaufsartikel / Accessories / Harvesting / Harvest pipes

2 L dip tube for harvesting, height-adjustable, angled, ID = 4 mm, with adapter M 10 x 1



bbi Scancode	BBI-43630042
Manufacturer	bbi-biotech GmbH
External Thread	M 10 x 1
Material Certificate	3.1, Rauigkeit, FDA
Country of Origin	DE 
HS-Code	73269098
Material	Stainless steel 316L EPDM black PTFE

Components	1x dip tube, 1x circlip [BBI-45110302], 1x clamp adapter [BBI-44630103]
Consumables	Coupling nut M 10 x 1 (high) (BBI-44130010) Coupling nut M 10 x 1 (flat) (BBI-44130009) O-ring for items to install in 11 mm ports (package of 10 pieces) (BBI-45100011) Circlip for dip tube for harvesting, height-adjustable (package of 10 pieces) (BBI-45110302) O-ring for adapter (package of 5 pieces) (BBI-45100025) Clamping cone (Package of 5 pieces) (BBI-44130017)
Related Products	2 L dip tube for harvesting, fix, ID = 8 mm, Pg 13,5 (BBI-43630016) 2 L dip tube for harvesting, fix, with baffle, ID = 4 mm, M 10 x 1 (BBI-43630063) 2 L dip tube for harvesting, height-adjustable, ID = 4 mm, with adapter M 10 x 1 (BBI-43630032)

Description:

- For Harvesting fluids from bioreactors
- Mounted in headplate
- Also used for sampling and adding media
- Variable installation depth with clamping adapter
- Installation port: M 10 x 1
- Angled version, height-adjustable
- With hose olive for hose with Di = 3.2 mm



To the Shop:



Alle / Verkaufsartikel / Accessories / Harvesting / Harvest pipes

5 L dip tube for harvesting, height-adjustable, angled, ID = 4 mm, with adapter M 10 x 1



bbi Scancode	BBI-43630043
Manufacturer	bbi-biotech GmbH
External Thread	M 10 x 1
Material Certificate	3.1, Rauigkeit, FDA
Country of Origin	DE 
HS-Code	73269098
Material	Stainless steel 316L EPDM black PTFE

Components	1x dip tube, 1x circlip [BBI-45110302], 1x clamp adapter [BBI-44630103]
Consumables	Coupling nut M 10 x 1 (high) (BBI-44130010) Coupling nut M 10 x 1 (flat) (BBI-44130009) O-ring for items to install in 11 mm ports (package of 10 pieces) (BBI-45100011) Circlip for dip tube for harvesting, height-adjustable (package of 10 pieces) (BBI-45110302) O-ring for adapter (package of 5 pieces) (BBI-45100025) Clamping cone (Package of 5 pieces) (BBI-44130017)
Related Products	0.5 L dip tube for harvesting, height-adjustable, ID = 4 mm, with adapter M 10 x 1 (BBI-43630030) 5 L dip tube for harvesting, fix, ID = 4 mm, M 10 x 1 (BBI-43630005) 5 L dip tube for harvesting, fix, ID = 8 mm, Pg 13,5 (BBI-43630017)

Description:

- For Harvesting fluids from bioreactors
- Mounted in headplate
- Also used for sampling and adding media
- Variable installation depth with clamping adapter
- Installation port: M 10 x 1
- Angled version, height-adjustable
- With hose olive for hose with Di = 3.2 mm



To the Shop:



Alle / Verkaufsartikel / Accessories / Harvesting / Harvest pipes

10 L dip tube for harvesting, height-adjustable, angled, ID = 4 mm, with adapter M 10 x 1



bbi Scancode	BBI-43630044
Manufacturer	bbi-biotech GmbH
External Thread	M 10 x 1
Material Certificate	3.1, Rauigkeit, FDA
Country of Origin	DE 
HS-Code	73269098
Material	Stainless steel 316L EPDM black PTFE

Components	1x dip tube, 1x circlip [BBI-45110302], 1x clamp adapter [BBI-44630103]
Consumables	Coupling nut M 10 x 1 (high) (BBI-44130010) Coupling nut M 10 x 1 (flat) (BBI-44130009) O-ring for items to install in 11 mm ports (package of 10 pieces) (BBI-45100011) Circlip for dip tube for harvesting, height-adjustable (package of 10 pieces) (BBI-45110302) O-ring for adapter (package of 5 pieces) (BBI-45100025) Clamping cone (Package of 5 pieces) (BBI-44130017)

Description:

- For Harvesting fluids from bioreactors
- Mounted in headplate
- Also used for sampling and adding media
- Variable installation depth with clamping adapter
- Installation port: M 10 x 1
- Angled version, height-adjustable
- With hose olive for hose with Di = 3.2 mm



To the Shop:



Alle / Verkaufsartikel / Accessories / Harvesting / Harvest pipes

0.5 L dip tube for harvesting, fix, angled, ID = 4 mm, M 10 x 1



bbi Scancode	BBI-43630045
Manufacturer	bbi-biotech GmbH
External Thread	M 10 x 1
Material Certificate	3.1, Rauigkeit, FDA
Country of Origin	DE 
HS-Code	73269098
Material	Stainless steel 316L EPDM black

Components	1x dip tube; 1x o-ring [BBI-45100011]; 1x coupling nut M10x1 [BBI-44130009]
Consumables	O-ring for items to install in 11 mm ports (package of 10 pieces) (BBI-45100011) Coupling nut M 10 x 1 (flat) (BBI-44130009)
Related Products	0,5 L dip tube for harvesting, fix, with baffle, ID = 4 mm, M 10 x 1 (BBI-43630061) 0.5 L dip tube for harvesting, fix, ID = 4 mm, M 10 x 1 (BBI-43630023) 0.5 L dip tube for harvesting, fix, ID = 8 mm, Pg 13,5 (BBI-43630025)

Description:

- For sterile harvesting of culture fluids from bioreactors and fermenters
- The length is matched to the culture vessel
- Mounted in headplate
- The media is taken from a fixed depth
- Also used for sampling and adding media
- Angled version
- Spare part for bioreactors



To the Shop:



Alle / Verkaufsartikel / Accessories / Harvesting / Harvest pipes

1 L dip tube for harvesting, fix, angled, ID = 4 mm, M 10 x 1



bbi Scancode	BBI-43630046
Manufacturer	bbi-biotech GmbH
External Thread	M 10 x 1
Material Certificate	3.1, Rauigkeit, FDA
Country of Origin	DE 
HS-Code	73269098
Material	Stainless steel 316L EPDM black

Components	1x dip tube; 1x o-ring [BBI-45100011]; 1x coupling nut M10x1 [BBI-44130009]
Consumables	O-ring for items to install in 11 mm ports (package of 10 pieces) (BBI-45100011) Coupling nut M 10 x 1 (flat) (BBI-44130009)
Related Products	1 L dip tube for harvesting, height-adjustable, ID = 4 mm, with adapter M 10 x 1 (BBI-43630031) 1 L dip tube for harvesting, height-adjustable, ID = 4 mm, without adapter M 10 x 1 (BBI-43630036) 1 L dip tube for harvesting, height-adjustable, angled, ID = 4 mm, with adapter M 10 x 1 (BBI-43630041)

Description:

- For sterile harvesting of culture fluids from bioreactors and fermenters
- The length is matched to the culture vessel
- Mounted in headplate
- The media is taken from a fixed depth
- Also used for sampling and adding media
- Angled version
- Spare part for bioreactors



Alle / Verkaufsartikel / Accessories / Harvesting / Harvest pipes

2 L dip tube for harvesting, fix, angled, ID = 4 mm, M 10 x 1



bbi Scancode	BBI-43630047
Manufacturer	bbi-biotech GmbH
External Thread	M 10 x 1
Material Certificate	3.1, Rauigkeit, FDA
Country of Origin	DE 
HS-Code	73269098
Material	Stainless steel 316L EPDM black

Components	1x dip tube; 1x o-ring [BBI-45100011]; 1x coupling nut M10x1 [BBI-44130009]
Consumables	O-ring for items to install in 11 mm ports (package of 10 pieces) (BBI-45100011) Coupling nut M 10 x 1 (flat) (BBI-44130009)
Related Products	2 L dip tube for harvesting, fix, ID = 4 mm, M 10 x 1 (BBI-43630012) 2 L dip tube for harvesting, fix, with baffle, ID = 4 mm, M 10 x 1 (BBI-43630063) 2 L dip tube for harvesting, height-adjustable, ID = 4 mm, with adapter M 10 x 1 (BBI-43630032)

Description:

- For sterile harvesting of culture fluids from bioreactors and fermenters
- The length is matched to the culture vessel
- Mounted in headplate
- The media is taken from a fixed depth
- Also used for sampling and adding media
- Angled version
- Spare part for bioreactors



To the Shop:



Alle / Verkaufsartikel / Accessories / Harvesting / Harvest pipes

5 L dip tube for harvesting, fix, angled, ID = 4 mm, M 10 x 1



bbi Scancode	BBI-43630048
Manufacturer	bbi-biotech GmbH
External Thread	M 10 x 1
Material Certificate	3.1, Rauigkeit, FDA
Country of Origin	DE 
HS-Code	73269098
Material	Stainless steel 316L EPDM black

Components	1x dip tube; 1x o-ring [BBI-45100011]; 1x coupling nut M10x1 [BBI-44130009]
Consumables	O-ring for items to install in 11 mm ports (package of 10 pieces) (BBI-45100011) Coupling nut M 10 x 1 (flat) (BBI-44130009)
Related Products	5 L dip tube for harvesting, fix, ID = 4 mm, M 10 x 1 (BBI-43630005) 5 L dip tube for harvesting, height-adjustable, ID = 4 mm, without adapter M 10 x 1 (BBI-43630038) 5 L dip tube for harvesting, height-adjustable, angled, ID = 4 mm, with adapter M 10 x 1 (BBI-43630043)

Description:

- For sterile harvesting of culture fluids from bioreactors and fermenters
- The length is matched to the culture vessel
- Mounted in headplate
- The media is taken from a fixed depth
- Also used for sampling and adding media
- Angled version
- Spare part for bioreactors



To the Shop:



Alle / Verkaufsartikel / Accessories / Harvesting / Harvest pipes

10 L dip tube for harvesting, fix, angled, ID = 4 mm, M 10 x 1



bbi Scancode	BBI-43630049
Manufacturer	bbi-biotech GmbH
External Thread	M 10 x 1
Material Certificate	3.1, Rauigkeit, FDA
Country of Origin	DE 
HS-Code	73269098
Material	Stainless steel 316L EPDM black

Components	1x dip tube; 1x o-ring [BBI-45100011]; 1x coupling nut M10x1 [BBI-44130009]
Consumables	O-ring for items to install in 11 mm ports (package of 10 pieces) (BBI-45100011) Coupling nut M 10 x 1 (flat) (BBI-44130009)

Description:

- For sterile harvesting of culture fluids from bioreactors and fermenters
- The length is matched to the culture vessel
- Mounted in headplate
- The media is taken from a fixed depth
- Also used for sampling and adding media
- Angled version
- Spare part for bioreactors



To the Shop:



Alle / Verkaufsartikel / Accessories / Harvesting / Harvest pipes

Harvest port 6 mm



bbi Scancode	BBI-43630050
Manufacturer	bbi-biotech GmbH
Internal Thread	Rd 28 x 1/8
External Thread	Rd 28 x 1/8
Material Certificate	3.1, Rauigkeit, FDA
Country of Origin	DE 
HS-Code	73269098
Weight	0.09 kg
Material	Stainless steel 316L EPDM black

Components	1x harvest port, 2x o-rings
Consumables	O-ring for items to install in Rd 28 x 1/8 ports (package of 10 pieces) (BBI-45100013) O-ring for adapter (package of 5 pieces) (BBI-45100025)
Related Products	1-way addition port Dm = 6 mm with hose nozzle 6 mm, Rd 28x1/8 (BBI-43630101) Harvest port 8 mm (BBI-43630051) Harvesting port with harvesting tube 8 mm (BBI-43630006)

Description:

- For harvesting or adding media
- For installtion in bioreactor lid
- For use with long inoculation needles [BBI-43630101], membrane [BBI-44130004] and membrane holder [BBI-44130005]
- For in-situ bioreactors
- Spare part for bioreactors



To the Shop:



Alle / Verkaufsartikel / Accessories / Harvesting / Harvest pipes

Harvest port 8 mm



bbi Scancode	BBI-43630051
Manufacturer	bbi-biotech GmbH
Internal Thread	Rd 28 x 1/8
External Thread	Rd 28 x 1/8
Material Certificate	3.1, Rauigkeit, FDA
Country of Origin	DE 
HS-Code	73269098
Weight	0.09 kg
Material	Stainless steel 316L EPDM black

Components	1x harvest port, 2x o-rings
Consumables	O-ring for items to install in Rd 28 x 1/8 ports (package of 10 pieces) (BBI-45100013) O-ring for items to install in 11 mm ports (package of 10 pieces) (BBI-45100011)
Related Products	1-way addition port Ø 6 mm with hose nozzle 8 mm, Rd 28x1/8 (BBI-43630102) Harvest port 6 mm (BBI-43630050) Harvesting port with harvesting tube 8 mm (BBI-43630006)

Description:

- For harvesting or adding media
- For installtion in bioreactor lid
- For use with long inoculation needles [BBI-43630102], membrane [BBI-44130004] and membrane holder [BBI-44130005]
- For in-situ bioreactors
- Spare part for bioreactors



To the Shop:



Alle / Verkaufsartikel / Accessories / Harvesting / Harvest pipes

0,25 L dip tube for harvesting, fix, with baffle, ID = 4 mm, M 10 x 1



bbi Scancode	BBI-43630060
Manufacturer	bbi-biotech GmbH
External Thread	M 10 x 1
Material Certificate	3.1, Rauigkeit
Material	Stainless steel 316L EPDM black

Components	1x dip tube
Related Products	0,25 L dip tube for harvesting, fix, ID = 4 mm (BBI-43630026) 0,25 L lid (BBI-44430352) 0.25 L jacketed glass vessel (BBI-44430054)

Description:

- For sterile harvesting of culture fluids from bioreactors and fermenters
- The length is matched to the culture vessel
- Mounted in headplate
- The media is taken from a fixed depth
- Also used for sampling and adding media
- Straight version
- With hose olive for hose with Di = 3.2 mm
- Spare part for bioreactors
- Baffles enable an enhanced mixing of cells, nutrients, and gases
- Improved mass transfer and oxygen distribution
- Optimized microbial culture productivity
- Disruption of liquid flow for efficient nutrient distribution
- Increased turbulence leading to better microbial growth



Alle / Verkaufsartikel / Accessories / Harvesting / Harvest pipes

0,5 L dip tube for harvesting, fix, with baffle, ID = 4 mm, M 10 x 1



bbi Scancode	BBI-43630061
Manufacturer	bbi-biotech GmbH
External Thread	M 10 x 1
Material Certificate	3.1, Rauigkeit, FDA
Country of Origin	DE 
Material	Stainless steel 316L EPDM black

Components	1x dip tube; 1x o-ring [BBI-45100011]; 1x coupling nut M10x1 [BBI-44130009]
Related Products	0.5 L dip tube for harvesting, fix, ID = 4 mm, M 10 x 1 (BBI-43630023) 0.5 L dip tube for harvesting, fix, ID = 8 mm, Pg 13,5 (BBI-43630025) 0.5 L dip tube for harvesting, fix, angled, ID = 4 mm, M 10 x 1 (BBI-43630045)

Description:

- For sterile harvesting of culture fluids from bioreactors and fermenters
- The length is matched to the culture vessel
- Mounted in headplate
- The media is taken from a fixed depth
- Also used for sampling and adding media
- Straight version
- With hose olive for hose with Di = 3.2 mm
- Spare part for bioreactors
- Baffles enable an enhanced mixing of cells, nutrients, and gases
- Improved mass transfer and oxygen distribution
- Optimized microbial culture productivity
- Disruption of liquid flow for efficient nutrient distribution
- Increased turbulence leading to better microbial growth



Alle / Verkaufsartikel / Accessories / Harvesting / Harvest pipes

1 L dip tube for harvesting, fix, with baffle, ID = 4 mm, M 10 x 1

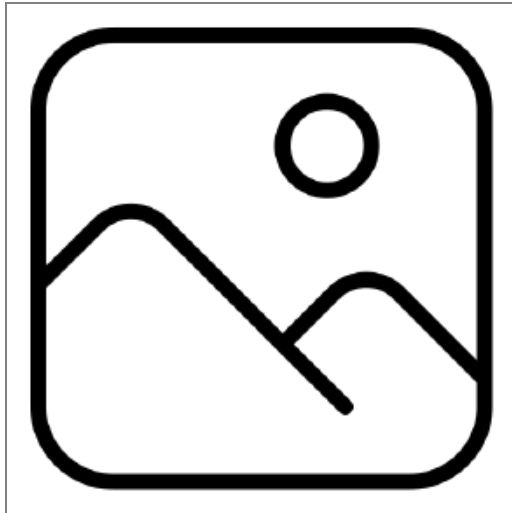

bbi Scancode	BBI-43630062
Manufacturer	bbi-biotech GmbH
External Thread	M 10 x 1
Material Certificate	3.1, Rauigkeit, FDA
Country of Origin	DE 
Material	Stainless steel 316L EPDM black

Components	1x dip tube; 1x o-ring [BBI-45100011]; 1x coupling nut M10x1 [BBI-44130009]
Related Products	1 L baffle (BBI-43230031) 1 L baffle, single (BBI-43530096) 1 L dip tube for harvesting, fix, ID = 4 mm, M 10 x 1 (BBI-43630013)

Description:

- For sterile harvesting of culture fluids from bioreactors and fermenters
- The length is matched to the culture vessel
- Mounted in headplate
- The media is taken from a fixed depth
- Also used for sampling and adding media
- Straight version
- With hose olive for hose with Di = 3.2 mm
- Spare part for bioreactors
- Baffles enable an enhanced mixing of cells, nutrients, and gases
- Improved mass transfer and oxygen distribution
- Optimized microbial culture productivity
- Disruption of liquid flow for efficient nutrient distribution
- Increased turbulence leading to better microbial growth



To the Shop:



Alle / Verkaufsartikel / Accessories / Harvesting / Harvest pipes

2 L dip tube for harvesting, fix, with baffle, ID = 4 mm, M 10 x 1



bbi Scancode	BBI-43630063
Manufacturer	bbi-biotech GmbH
External Thread	M 10 x 1
Material Certificate	3.1, Rauigkeit, FDA
Country of Origin	DE 
Material	Stainless steel 316L EPDM black

Components	1x dip tube; 1x o-ring [BBI-45100011]; 1x coupling nut M10x1 [BBI-44130009]
Related Products	2 L baffle, single (BBI-43530097) 2 L dip tube for harvesting, fix, ID = 4 mm, M 10 x 1 (BBI-43630012) 2 L dip tube for harvesting, fix, angled, ID = 4 mm, M 10 x 1 (BBI-43630047)

Description:

- For sterile harvesting of culture fluids from bioreactors and fermenters
- The length is matched to the culture vessel
- Mounted in headplate
- The media is taken from a fixed depth
- Also used for sampling and adding media
- Straight version
- With hose olive for hose with Di = 3.2 mm
- Spare part for bioreactors
- Baffles enable an enhanced mixing of cells, nutrients, and gases
- Improved mass transfer and oxygen distribution
- Optimized microbial culture productivity
- Disruption of liquid flow for efficient nutrient distribution
- Increased turbulence leading to better microbial growth



Alle / Verkaufsartikel / Accessories / Harvesting / Harvest pipes

5 L dip tube for harvesting, fix, with baffle, ID = 4 mm, M 10 x 1



bbi Scancode	BBI-43630064
Manufacturer	bbi-biotech GmbH
External Thread	M 10 x 1
Material Certificate	3.1, Rauigkeit, FDA
Country of Origin	DE 
Material	Stainless steel 316L EPDM black

Components	1x dip tube; 1x o-ring [BBI-45100011]; 1x coupling nut M10x1 [BBI-44130009]
Related Products	5 L baffle, single (BBI-43530098) 5 L dip tube for harvesting, fix, ID = 4 mm, M 10 x 1 (BBI-43630005) 5 L dip tube for harvesting, fix, ID = 8 mm, Pg 13,5 (BBI-43630017)

Description:

- For sterile harvesting of culture fluids from bioreactors and fermenters
- The length is matched to the culture vessel
- Mounted in headplate
- The media is taken from a fixed depth
- Also used for sampling and adding media
- Straight version
- With hose olive for hose with Di = 3.2 mm
- Spare part for bioreactors
- Baffles enable an enhanced mixing of cells, nutrients, and gases
- Improved mass transfer and oxygen distribution
- Optimized microbial culture productivity
- Disruption of liquid flow for efficient nutrient distribution
- Increased turbulence leading to better microbial growth



To the Shop:



Alle / Verkaufsartikel / Accessories / Harvesting / Harvest pipes

10 L dip tube for harvesting, fix, with baffle, ID = 4 mm, M 10 x 1



bbi Scancode	BBI-43630065
Manufacturer	bbi-biotech GmbH
External Thread	M 10 x 1
Material Certificate	3.1, Rauigkeit, FDA
Material	Stainless steel 316L EPDM black

Components

1x dip tube; 1x o-ring [BBI-45100011]; 1x coupling nut M10x1 [BBI-44130009]

Description:

- For sterile harvesting of culture fluids from bioreactors and fermenters
- The length is matched to the culture vessel
- Mounted in headplate
- The media is taken from a fixed depth
- Also used for sampling and adding media
- Straight version
- With hose olive for hose with Di = 3.2 mm
- Spare part for bioreactors
- Baffles enable an enhanced mixing of cells, nutrients, and gases
- Improved mass transfer and oxygen distribution
- Optimized microbial culture productivity
- Disruption of liquid flow for efficient nutrient distribution
- Increased turbulence leading to better microbial growth



To the Shop:



Alle / Verkaufsartikel / Accessories / Harvesting / Harvest pipes

2 L Harvesting tube, fixed, Di = 4 mm, M 10 x 1, slightly angled



bbi Scancode	BBI-43630067
Manufacturer	bbi-biotech GmbH
External Thread	M 10 x 1
Material Certificate	3.1, Rauigkeit, FDA
Country of Origin	DE 
Weight	0.04 kg
Material	Stainless steel 316L EPDM black

Components	1x dip tube; 1x o-ring [BBI-45100011]; 1x coupling nut M10x1 [BBI-44130009]
Related Products	2 L dip tube for harvesting, fix, ID = 4 mm, M 10 x 1 (BBI-43630012) 2 L dip tube for harvesting, fix, ID = 8 mm, Pg 13,5 (BBI-43630016) 2 L dip tube for harvesting, height-adjustable, ID = 4 mm, with adapter M 10 x 1 (BBI-43630032)

Description:

- For sterile harvesting of culture fluids from bioreactors and fermenters
- The length is matched to the culture vessel
- Mounted in headplate
- The media is taken from a fixed depth
- Also used for sampling and adding media
- Angled version
- Spare part for bioreactors



To the Shop:



Alle / Verkaufsartikel / Accessories / Harvesting / Spinfilters

2 L spinfilter 40 µm



bbi Scancode	BBI-43630302
Manufacturer	bbi-biotech GmbH
Material Certificate	3.1, FDA
Country of Origin	DE 
HS-Code	84212980
Material	Stainless steel 316L EPDM black

Components	1x spin filter, 2x grub screw, 2x O-ring
Related Products	2 L spinfilter 10 µm (BBI-43630312) 2 L spinfilter 20 µm (BBI-43630313) 2 L spinfilter 75 µm (BBI-43630303)
Description: <ul style="list-style-type: none"> • 4-layer square mesh made of stainless steel • Installation on stirrer shaft • Pore size 40 µm • For 2L vessels • OD 58 mm • For 10mm shafts • Total length: 133 mm 	



To the Shop:



Alle / Verkaufsartikel / Accessories / Harvesting / Spinfilters

2 L spinfilter 75 µm



bbi Scancode	BBI-43630303
Manufacturer	bbi-biotech GmbH
Material Certificate	3.1, FDA
Country of Origin	DE 
HS-Code	84212980
Material	Stainless steel 316L EPDM black

Components	1x spin filter, 2x grub screw, 2x O-ring
Related Products	2 L spinfilter 10 µm (BBI-43630312) 2 L spinfilter 20 µm (BBI-43630313) 2 L spinfilter 40 µm (BBI-43630302)
Description: <ul style="list-style-type: none"> • 4-layer square mesh made of stainless steel • Installation on stirrer shaft • Pore size 75 µm • For 2L vessels • OD 58 mm • For 10mm shafts • Total length: 133 mm 	



To the Shop:



Alle / Verkaufsartikel / Accessories / Harvesting / Spinfilters

5 L spinfilter 10 µm



bbi Scancode	BBI-43630304
Manufacturer	bbi-biotech GmbH
Material Certificate	3.1, FDA
Country of Origin	DE 
HS-Code	84212980
Material	Stainless steel 316L EPDM black

Components	1x spin filter, 2x grub screw, 2x O-ring
Related Products	5 L spinfilter 20 µm (BBI-43630305) 5 L spinfilter 40 µm (BBI-43630306) 5 L spinfilter 75 µm (BBI-43630307)
Description: <ul style="list-style-type: none"> • 4-layer square mesh made of stainless steel • Installation on stirrer shaft • Pore size 10 µm • For 5 L vessels • OD 58 mm • For 10mm shafts • Total length: 185 mm 	



To the Shop:



Alle / Verkaufsartikel / Accessories / Harvesting / Spinfilters

5 L spinfilter 20 µm



bbi Scancode	BBI-43630305
Manufacturer	bbi-biotech GmbH
Material Certificate	3.1, FDA
Country of Origin	DE 
HS-Code	84212980
Material	Stainless steel 316L EPDM black

Components	1x spin filter, 2x grub screw, 2x O-ring
Related Products	5 L spinfilter 10 µm (BBI-43630304) 5 L spinfilter 40 µm (BBI-43630306) 5 L spinfilter 75 µm (BBI-43630307)

Description:

- 4-layer square mesh made of stainless steel
- Installation on stirrer shaft
- Pore size 20 µm
- For 5 L vessels
- OD 58 mm
- For 10mm shafts
- Total length: 185 mm



To the Shop:



Alle / Verkaufsartikel / Accessories / Harvesting / Spinfilters

5 L spinfilter 40 µm



bbi Scancode	BBI-43630306
Manufacturer	bbi-biotech GmbH
Material Certificate	3.1, FDA
Country of Origin	DE 
HS-Code	84212980
Material	Stainless steel 316L EPDM black

Components	1x spin filter, 2x grub screw, 2x O-ring
Related Products	5 L spinfilter 10 µm (BBI-43630304) 5 L spinfilter 20 µm (BBI-43630305) 5 L spinfilter 75 µm (BBI-43630307)
Description: <ul style="list-style-type: none"> • 4-layer square mesh made of stainless steel • Installation on stirrer shaft • Pore size 40 µm • For 5 L vessels • OD 58 mm • For 10mm shafts • Total length: 185 mm 	



To the Shop:



Alle / Verkaufsartikel / Accessories / Harvesting / Spinfilters

5 L spinfilter 75 µm



bbi Scancode	BBI-43630307
Manufacturer	bbi-biotech GmbH
Material Certificate	3.1, FDA
Country of Origin	DE 
HS-Code	84212980
Material	Stainless steel 316L EPDM black

Components	1x spin filter, 2x grub screw, 2x O-ring
Related Products	5 L spinfilter 10 µm (BBI-43630304) 5 L spinfilter 20 µm (BBI-43630305) 5 L spinfilter 40 µm (BBI-43630306)
Description: <ul style="list-style-type: none"> • 4-layer square mesh made of stainless steel • Installation on stirrer shaft • Pore size 75 µm • For 5 L vessels • OD 58 mm • For 10mm shafts • Total length: 185 mm 	



To the Shop:



Alle / Verkaufsartikel / Accessories / Harvesting / Spinfilters

10 L spinfilter 10 µm



bbi Scancode	BBI-43630308
Manufacturer	bbi-biotech GmbH
Material Certificate	3.1, FDA
Country of Origin	DE 
HS-Code	84212980
Material	Stainless steel 316L EPDM black

Components	1x spin filter, 2x grub screw, 2x O-ring
Related Products	10 L spinfilter 20 µm (BBI-43630309) 10 L spinfilter 40 µm (BBI-43630310) 10 L spinfilter 75 µm (BBI-43630311)
<p>Description:</p> <ul style="list-style-type: none"> • 4-layer square mesh made of stainless steel • Installation on stirrer shaft • Pore size 10 µm • For 10 L vessels • OD 70 mm • For 16mm shafts • Total length: 220 mm 	



Alle / Verkaufsartikel / Accessories / Harvesting / Spinfilters

10 L spinfilter 20 µm



bbi Scancode	BBI-43630309
Manufacturer	bbi-biotech GmbH
Material Certificate	3.1, FDA
Country of Origin	DE 
HS-Code	84212980
Material	Stainless steel 316L EPDM black

Components	1x spin filter, 2x grub screw, 2x O-ring
Consumables	O-ring for items to install in M 26 x 1 ports (package of 10 pieces) (BBI-45100015)
Related Products	10 L spinfilter 10 µm (BBI-43630308) 10 L spinfilter 40 µm (BBI-43630310) 10 L spinfilter 75 µm (BBI-43630311)

Description:

- 4-layer square mesh made of stainless steel
- Installation on stirrer shaft
- Pore size 20 µm
- For 10 L vessels
- OD 70 mm
- For 16mm shafts
- Total length: 220 mm



To the Shop:



Alle / Verkaufsartikel / Accessories / Harvesting / Spinfilters

10 L spinfilter 40 µm



bbi Scancode	BBI-43630310
Manufacturer	bbi-biotech GmbH
Material Certificate	3.1, FDA
Country of Origin	DE 
HS-Code	84212980
Material	Stainless steel 316L EPDM black

Components	1x spin filter, 2x grub screw, 2x O-ring
Related Products	10 L spinfilter 10 µm (BBI-43630308) 10 L spinfilter 20 µm (BBI-43630309) 10 L spinfilter 75 µm (BBI-43630311)

Description:

- 4-layer square mesh made of stainless steel
- Installation on stirrer shaft
- Pore size 40 µm
- For 10 L vessels
- OD 70 mm
- For 16mm shafts
- Total length: 220 mm



To the Shop:



Alle / Verkaufsartikel / Accessories / Harvesting / Spinfilters

10 L spinfilter 75 µm



bbi Scancode	BBI-43630311
Manufacturer	bbi-biotech GmbH
Material Certificate	3.1, FDA
Country of Origin	DE 
HS-Code	84212980
Material	Stainless steel 316L EPDM black

Components	1x spin filter, 2x grub screw, 2x O-ring
Related Products	10 L spinfilter 10 µm (BBI-43630308) 10 L spinfilter 20 µm (BBI-43630309) 10 L spinfilter 40 µm (BBI-43630310)

Description:

- 4-layer square mesh made of stainless steel
- Installation on stirrer shaft
- Pore size 75 µm
- For 10 L vessels
- OD 70 mm
- For 16mm shafts
- Total length: 220 mm



To the Shop:



Alle / Verkaufsartikel / Accessories / Harvesting / Spinfilters

2 L spinfilter 10 µm



bbi Scancode	BBI-43630312
Manufacturer	bbi-biotech GmbH
Material Certificate	3.1, FDA
Country of Origin	DE 
HS-Code	84212980
Material	Stainless steel 316L EPDM black

Components	1x spin filter, 2x grub screw, 2x O-ring
Related Products	2 L spinfilter 20 µm (BBI-43630313) 2 L spinfilter 40 µm (BBI-43630302) 2 L spinfilter 75 µm (BBI-43630303)
Description: <ul style="list-style-type: none"> • 4-layer square mesh made of stainless steel • Installation on stirrer shaft • Pore size 10 µm • For 2L vessels • OD 58 mm • For 10mm shafts • Total length: 133 mm 	



To the Shop:



Alle / Verkaufsartikel / Accessories / Harvesting / Spinfilters

2 L spinfilter 20 µm



bbi Scancode	BBI-43630313
Manufacturer	bbi-biotech GmbH
Material Certificate	3.1, FDA
Country of Origin	DE 
HS-Code	84212980
Material	Stainless steel 316L EPDM black

Components	1x spin filter, 2x grub screw, 2x O-ring
Related Products	2 L spinfilter 10 µm (BBI-43630312) 2 L spinfilter 40 µm (BBI-43630302) 2 L spinfilter 75 µm (BBI-43630303)

Description:

- 4-layer square mesh made of stainless steel
- Installation on stirrer shaft
- Pore size 20 µm
- For 2L vessels
- OD 58 mm
- For 10mm shafts
- Total length: 133 mm



To the Shop:



Alle / Verkaufsartikel / Accessories / Harvesting / Spinfilters

External spinfilter 10 µm



bbi Scancode	BBI-43630320
Manufacturer	bbi-biotech GmbH
Country of Origin	DE 
HS-Code	84212980
Material	Stainless steel 316L

Components	
Related Products	<p>10 L spinfilter 20 µm (BBI-43630309)</p> <p>5 L spinfilter 40 µm (BBI-43630306)</p> <p>External spinfilter 20 µm (BBI-43630321)</p>
<p>Description:</p> <ul style="list-style-type: none"> • 4-layer square mesh made of stainless steel • Pore size 10 µm 	



Alle / Verkaufsartikel / Accessories / Harvesting / Spinfilters

External spinfilter 20 µm



bbi Scancode	BBI-43630321
Manufacturer	bbi-biotech GmbH
Country of Origin	DE 
HS-Code	84212980
Material	Stainless steel 316L

Components	
Related Products	2 L spinfilter 75 µm (BBI-43630303) 5 L spinfilter 10 µm (BBI-43630304) External spinfilter 10 µm (BBI-43630320)
Description: <ul style="list-style-type: none"> • 4-layer square mesh made of stainless steel • Pore size 20 µm 	



To the Shop:



Alle / Verkaufsartikel / Accessories / Addition / Addition ports

1-way addition port Dm = 6 mm with hose nozzle 6 mm, Rd 28x1/8



bbi Scancode	BBI-43630101
Manufacturer	bbi-biotech GmbH
External Thread	Rd 28 x 1/8
Material Certificate	3.1, Rauigkeit, FDA
Country of Origin	DE 
HS-Code	73269098
Weight	0.18 kg
Material	Stainless steel 316L EPDM black

Components

1x inoculation port; 1x o-ring [BBI-45100013]

Description:

- For the addition of inoculation cultures or additional media to a bioreactor
- Extended version of the needle for use with harvest port
- Cannula 6 x 1 mm
- With hose nozzles for silicone tube 3.2 x 1.6 mm



To the Shop:



Alle / Verkaufsartikel / Accessories / Addition / Addition ports

1-way addition port Ø 6 mm with hose nozzle 8 mm, Rd 28x1/8



bbi Scancode	BBI-43630102
Manufacturer	bbi-biotech GmbH
External Thread	Rd 28 x 1/8
Material Certificate	3.1, Rauigkeit, FDA
Country of Origin	DE 
HS-Code	73269098
Material	Stainless steel 316L EPDM black

Components 1x inoculation port; 1x o-ring [BBI-45100013]

Description:

- For the addition of inoculation cultures or additional media to a bioreactor
- Extended version of the needle for use with harvest port
- Cannula 6 x 1 mm
- With hose nozzles for silicone tube 3,2 x 1,6 mm



To the Shop:



Alle / Verkaufsartikel / Accessories / Addition / Addition ports

1-way addition port Ø 6 mm, Rd 28 x 1/8



bbi Scancode	BBI-43630103
Manufacturer	bbi-biotech GmbH
External Thread	Rd 28 x 1/8
Material Certificate	3.1, Rauigkeit, FDA
Country of Origin	DE 
HS-Code	73269098
Weight	0.22 kg
Material	Stainless steel 316L EPDM black

Components	1x inoculation port; 1x o-ring [BBI-45100013]
Consumables	O-ring for items to install in Rd 28 x 1/8 ports (package of 10 pieces) (BBI-45100013)
<p>Description:</p> <ul style="list-style-type: none"> • For the addition of inoculation cultures or additional media to a bioreactor • For use with autoclavable media bottles • Sterile sleeve is available separately • Cannula 6 x 1 mm • With hose nozzles for silicone tube 3.2 x 1.6 mm 	



To the Shop:



Alle / Verkaufsartikel / Accessories / Addition / Addition ports

1-way addition port Dm=8 mm, Rd 28x1/8



bbi Scancode	BBI-43630104
Manufacturer	bbi-biotech GmbH
External Thread	Rd 28 x 1/8
Material Certificate	3.1, Rauigkeit, FDA
Country of Origin	DE 
HS-Code	73269098
Weight	0.22 kg
Material	Stainless steel 316L EPDM black

Components	1x inoculation port; 1x o-ring [BBI-45100013]
Consumables	O-ring for items to install in Rd 28 x 1/8 ports (package of 10 pieces) (BBI-45100013)
Description: <ul style="list-style-type: none"> • For the addition of inoculation cultures or additional media to a bioreactor • For use with autoclavable media bottles • Sterile sleeve is available separately • Cannula 8 x 1 mm 	



To the Shop:



Alle / Verkaufsartikel / Accessories / Addition / Addition ports

3-way addition port Ø 8 mm, Rd 28 x 1/8



bbi Scancode	BBI-43630105
Manufacturer	bbi-biotech GmbH
External Thread	Rd 28 x 1/8
Material Certificate	3.1, Rauigkeit, FDA
Country of Origin	DE 
HS-Code	73269098
Weight	0.3 kg
Material	Stainless steel 316L EPDM black

Components	1x inoculation port; 1x o-ring [BBI-45100013]
Related Products	1-way addition port Ø 4 mm, Rd 28 x 1/8 (BBI-43630106) 3-way Sacova 4 mm for Rd 28 x 1/8 standard port (BBI-43630206) 3-way addition port Ø 8 mm, M 26 x 1 (BBI-43630110)

Description:

- For the addition of inoculation cultures or additional media to a bioreactor
- 3-way port with straight hose nozzles
- For use with autoclavable media bottles
- To autoclave with sterile sleeve (available separately)
- Diameter needle 8 mm
- With hose nozzles for silicone tube 1.6 x 0.8 mm



Alle / Verkaufsartikel / Accessories / Addition / Addition ports

1-way addition port Ø 4 mm, Rd 28 x 1/8



bbi Scancode	BBI-43630106
Manufacturer	bbi-biotech GmbH
External Thread	Rd 28 x 1/8
Material Certificate	3.1, Rauigkeit, FDA
Country of Origin	DE 
HS-Code	73269098
Weight	0.22 kg
Material	Stainless steel 316L EPDM black

Components	1x inoculation port; 1x o-ring [BBI-45100013]
Consumables	O-ring for items to install in Rd 28 x 1/8 ports (package of 10 pieces) (BBI-45100013)
Related Products	1-way addition port Dm=8 mm, Rd 28x1/8 (BBI-43630104) 1-way addition port Ø 6 mm, Rd 28 x 1/8 (BBI-43630103) 3-way addition port Ø 8 mm, Rd 28 x 1/8 (BBI-43630105)

Description:

- For the addition of inoculation cultures or additional media to a bioreactor
- For use with autoclavable media bottles
- Sterile sleeve is available separately [BBI-44130013]
- Diameter 4 mm
- With hose nozzles for silicone tube 1.6 x 0.8 mm
- Spare part for bioreactors



To the Shop:



Alle / Verkaufsartikel / Accessories / Addition / Addition ports

1-way addition port Ø 4 mm, M 26 x 1



bbi Scancode	BBI-43630107
Manufacturer	bbi-biotech GmbH
External Thread	M 26 x 1
Material Certificate	3.1, Rauigkeit, FDA
Country of Origin	DE 
HS-Code	73269098
Weight	0.22 kg
Material	Stainless steel 316L EPDM black

Components	1x inoculation port; 1x o-ring [BBI-45100013]
-------------------	---

Description:

- For the addition of inoculation cultures or additional media to a bioreactor
- For use with autoclavable media bottles
- Sterile sleeve is available separately [BBI-44130019]
- Diameter 6 mm
- With hose nozzles for silicone tube 3.2 x 1.6 mm
- Spare part for bioreactors



To the Shop:



Alle / Verkaufsartikel / Accessories / Addition / Addition ports

1-way addition port Ø 6 mm, M 26 x 1



bbi Scancode	BBI-43630108
Manufacturer	bbi-biotech GmbH
External Thread	M 26 x 1
Material Certificate	3.1, Rauigkeit, FDA
Country of Origin	DE 
HS-Code	73269098
Weight	0.22 kg
Material	Stainless steel 316L EPDM black

Components	1x inoculation port; 1x o-ring [BBI-45100013]
Consumables	O-ring for items to install in Rd 28 x 1/8 ports (package of 10 pieces) (BBI-45100013)

Description:

- For the addition of inoculation cultures or additional media to a bioreactor
- For use with autoclavable media bottles
- Sterile sleeve is available separately [BBI-44130019]
- Diameter 4 mm
- With hose nozzles for silicone tube 1.6 x 0.8 mm
- Spare part for bioreactors



To the Shop:



Alle / Verkaufsartikel / Accessories / Addition / Addition ports

1-way addition port Ø 8 mm, M 26 x 1



bbi Scancode	BBI-43630109
Manufacturer	bbi-biotech GmbH
External Thread	M 26 x 1
Material Certificate	3.1, Rauigkeit, FDA
Country of Origin	DE 
HS-Code	73269098
Weight	0.22 kg
Material	Stainless steel 316L EPDM black

Components	1x inoculation port; 1x o-ring [BBI-45100013]
Consumables	O-ring for items to install in Rd 28 x 1/8 ports (package of 10 pieces) (BBI-45100013)

Description:

- For the addition of inoculation cultures or additional media to a bioreactor
- For use with autoclavable media bottles
- Sterile sleeve is available separately [BBI-44130019]
- Diameter 8 mm
- With hose nozzles
- Spare part for bioreactors



To the Shop:



Alle / Verkaufsartikel / Accessories / Addition / Addition ports

3-way addition port Ø 8 mm, M 26 x 1



bbi Scancode	BBI-43630110
Manufacturer	bbi-biotech GmbH
External Thread	M 26 x 1
Material Certificate	3.1, Rauigkeit, FDA
Country of Origin	DE 
HS-Code	73269098
Weight	0.3 kg
Material	Stainless steel 316L EPDM black

Components	1x inoculation port; 1x o-ring [BBI-45100013]
Related Products	1-way addition port Ø 6 mm, M 26 x 1 (BBI-43630108) 3-way Sacova 4 mm for Rd 28 x 1/8 standard port (BBI-43630206) 3-way addition port Ø 8 mm, Rd 28 x 1/8 (BBI-43630105)

Description:

- For the addition of inoculation cultures or additional media to a bioreactor
- 3-way port with straight hose nozzles
- For use with autoclavable media bottles
- To autoclave with sterile sleeve (available separately)
- Diameter needle 8 mm
- With hose nozzles for silicone tube 1.6 x 0.8 mm



To the Shop:



Alle / Verkaufsartikel / Accessories / Addition / Addition ports

4-way addition port M 26 x 1



bbi Scancode	BBI-43630202
Manufacturer	bbi-biotech GmbH
External Thread	M 26 x 1
Material Certificate	3.1, Rauigkeit, FDA
Country of Origin	DE 
HS-Code	73269098
Weight	0.11 kg
Material	Stainless steel 316L EPDM black

Components	1x 4-way addition port with coupling nut; 1x o-ring [BBI-45100015]
Consumables	O-ring for items to install in M 26 x 1 ports (package of 10 pieces) (BBI-45100015)
Related Products	2-way addition port M 26 x 1 (BBI-43630250) 3-way addition port 4 mm, PG 13.5 (BBI-43630252) 3-way addition port for 11 mm port (BBI-43630258)

Description:

- For the addition of inoculation cultures or additional media to a bioreactor
- Four ports for adding
- With movable union nut so that hoses can be attached before screwing in
- For use with autoclavable media bottles
- Autoclavable with sterile sleeve
- With 4 hose nozzles ID = 2 mm for hose with Di = 1.6 mm
- Spare part for bioreactors



To the Shop:



Alle / Verkaufsartikel / Accessories / Addition / Addition ports

4-way addition port NPT 3/4"



bbi Scancode	BBI-43630221
Country of Origin	DE 

Components

Description:

- For the addition of inoculation cultures or additional media to a bioreactor
- Four ports for adding
- For use with autoclavable media bottles
- With 4 hose noozles ID = 2 mm for hose with Di = 1.6 mm
- Spare part for bioreactors



To the Shop:



Alle / Verkaufsartikel / Accessories / Addition / Addition ports

2-way addition port M 26 x 1



bbi Scancode	BBI-43630250
Manufacturer	bbi-biotech GmbH
External Thread	M 26 x 1
Material Certificate	3.1, Rauigkeit, FDA
Country of Origin	DE 
HS-Code	73269098
Material	Stainless steel 316L EPDM black

Components	1x inoculation port; 1x flat seal [BBI-44130214]
Related Products	2-way addition port 4 mm, PG 13.5 (BBI-43630251) 4-way addition port M 26 x 1 (BBI-43630202) Blind plug for 19 mm ports M 26 x 1 (BBI-44130201)

Description:

- For the addition of inoculation cultures or additional media to a bioreactor
- Four ports for adding
- For use with autoclavable media bottles
- Autoclavable with sterile sleeve
- With 4 hose noozles ID = 2 mm for hose with Di = 1.6 mm
- Spare part for bioreactors



To the Shop:



Alle / Verkaufsartikel / Accessories / Addition / Addition ports

2-way addition port 4 mm, PG 13.5



bbi Scancode	BBI-43630251
Manufacturer	bbi-biotech GmbH
External Thread	Pg 13,5
Material Certificate	3.1, Rauigkeit, FDA
Country of Origin	DE 
HS-Code	73269098
Weight	0.22 kg
Material	Stainless steel 316L EPDM black

Components	1x inoculation port; 1x flat seal [BBI-44130214]
Consumables	Flat seal with hole for 12 mm ports (package of 5 pieces) (BBI-44130214)
Related Products	1-way addition port 4 mm, PG 13.5 (BBI-43630254) 3-way addition port 4 mm, PG 13.5 (BBI-43630252) Blind plug Pg 13.5 (BBI-44130206)

Description:

- For the addition of inoculation cultures or additional media to a bioreactor
- With 2 straight tubing hose nozzles for silicone tubing 1.6 x 0.8 mm
- Independent addition channels
- For use with autoclavable media bottles
- Spare part for bioreactors



Alle / Verkaufsartikel / Accessories / Addition / Addition ports

3-way addition port 4 mm, PG 13.5



bbi Scancode	BBI-43630252
Manufacturer	bbi-biotech GmbH
External Thread	Pg 13,5
Material Certificate	3.1, Rauigkeit, FDA
Country of Origin	DE 
HS-Code	73269098
Weight	0.07 kg
Material	Stainless steel 316L EPDM black

Components	1x inoculation port; 1x flat seal [BBI-44130214]
Consumables	Flat seal with hole for 12 mm ports (package of 5 pieces) (BBI-44130214)
Related Products	2-way addition port 4 mm, PG 13.5 (BBI-43630251) 3-way addition port 4 mm, PG 13.5, with angled hose nozzles (BBI-43630253) 3-way addition port for 11 mm port (BBI-43630258)

Description:

- For the addition of inoculation cultures or additional media to a bioreactor
- With 3 straight tubing hose nozzles for silicone tubing 1.6 x 0.8 mm
- Independent addition channels
- For use with autoclavable media bottles
- Spare part for bioreactors



To the Shop:



Alle / Verkaufsartikel / Accessories / Addition / Addition ports

3-way addition port 4 mm, PG 13.5, with angled hose nozzles



bbi Scancode	BBI-43630253
Manufacturer	bbi-biotech GmbH
External Thread	Pg 13,5
Material Certificate	3.1, Rauigkeit, FDA
Country of Origin	DE 
HS-Code	73269098
Weight	0.07 kg
Material	Stainless steel 316L EPDM black

Components	1x inoculation port; 1x flat seal [BBI-44130214]
Consumables	Flat seal with hole for 12 mm ports (package of 5 pieces) (BBI-44130214)
Related Products	2-way addition port 4 mm, PG 13.5 (BBI-43630251) 3-way addition port 4 mm, PG 13.5 (BBI-43630252) 3-way addition port for 11 mm port (BBI-43630258)

Description:

- For the addition of inoculation cultures or additional media to a bioreactor
- With 3 angled tubing hose nozzles for silicone tubing 1.6 x 0.8 mm
- Independent addition channels
- For use with autoclavable media bottles
- Spare part for bioreactors



Alle / Verkaufsartikel / Accessories / Addition / Addition ports

1-way addition port 4 mm, PG 13.5



bbi Scancode	BBI-43630254
Manufacturer	bbi-biotech GmbH
External Thread	Pg 13,5
Material Certificate	3.1, Rauigkeit, FDA
Country of Origin	DE 
HS-Code	73269098
Weight	0.06 kg
Material	Stainless steel 316L EPDM black

Components	1x inoculation port; 1x flat seal [BBI-44130214]
Consumables	Flat seal with hole for 12 mm ports (package of 5 pieces) (BBI-44130214)
Description: <ul style="list-style-type: none"> • For the addition of inoculation cultures or additional media to a bioreactor • With 1 straight tubing hose nozzle for silicone tubing 1.6 x 0.8 mm • For use with autoclavable media bottles • Spare part for bioreactors 	



To the Shop:



Alle / Verkaufsartikel / Accessories / Addition / Addition ports

1-way addition port 6 mm, PG 13.5



bbi Scancode	BBI-43630255
Manufacturer	bbi-biotech GmbH
External Thread	Pg 13,5
Material Certificate	3.1, Rauigkeit, FDA
Country of Origin	DE 
HS-Code	73269098
Weight	0.06 kg
Material	Stainless steel 316L EPDM black

Components	1x inoculation port; 1x flat seal [BBI-44130214]
Consumables	Flat seal with hole for 12 mm ports (package of 5 pieces) (BBI-44130214)

Description:

- For the addition of inoculation cultures or additional media to a bioreactor
- With 1 straight tubing hose nozzle for silicone tubing 3.2 x 1.6 mm
- For use with autoclavable media bottles
- Spare part for bioreactors



Alle / Verkaufsartikel / Accessories / Addition / Addition ports

3-way addition port for 11 mm port



bbi Scancode	BBI-43630258
Manufacturer	bbi-biotech GmbH
External Thread	M 10 x 1
Material Certificate	3.1, Rauigkeit, FDA
Country of Origin	DE 
Material	Stainless steel 316L EPDM black

Components	1x addition port, 1x coupling nut [BBI-44130009], 1x o-ring [BBI-45100011]
Related Products	3-way addition port 4 mm, PG 13.5 (BBI-43630252) Universal adapter 6-4 (BBI-43930003) Universal adapter 8.5 (BBI-43930002)

Description:

- For the addition of inoculation cultures or additional media to a bioreactor
- With 3 straight tubing hose nozzles 3.0 x 0.7 mm
- Independent addition channels
- For use with autoclavable media bottles
- Spare part for bioreactors



Alle / Verkaufsartikel / Accessories / Addition / Inoculation ports

Inoculation port with septum for 11 mm ports



bbi Scancode	BBI-43630200
Manufacturer	bbi-biotech GmbH
External Thread	M 10 x 1
Material Certificate	3.1, Rauigkeit, FDA
Country of Origin	DE 
HS-Code	73269098
Weight	0.02 kg
Material	Stainless steel 316L EPDM black silicone

Components	1x membrane holder with cap; 1x coupling nut M10x1 [BBI-44130009]; 1x o-ring [BBI-45100011]; 1x membrane [BBI-43830001]
Consumables	O-ring for items to install in 11 mm ports (package of 10 pieces) (BBI-45100011) Coupling nut M 10 x 1 (flat) (BBI-44130009) O-ring for inoculation port cap (package of 5 pieces) (BBI-45100026) Membrane/septa for inoculation port or manual bypass sampler (package of 10 pieces) (BBI-43830001)
Related Products	1-way addition port Ø 4 mm, M 26 x 1 (BBI-43630107) Membrane/septa for inoculation port or manual bypass sampler (latex) (package of 10 pieces) (BBI-43830007) Membrane/septa for inoculation port or manual bypass sampler (package of 10 pieces) (BBI-43830001)

Description:

- For the safe addition of inoculation cultures or additional media to a bioreactor
- For piercing with injection needles or syringes
- For the use with disposable membranes [BBI-43830001] or [BBI-43830007]
- ID = 4 mm
- Spare part/accessory for bioreactors



To the Shop:



Alle / Verkaufsartikel / Accessories / Addition / Headpieces

Headpiece for manual sampler (classical)



bbi Scancode	BBI-43830005
Manufacturer	bbi-biotech GmbH
Material Certificate	3.1, Rauigkeit
Country of Origin	DE 
HS-Code	73269098
Weight	0.02 kg
Material	Stainless steel 316L

Components	1x headpiece
Related Products	Manual sampler (classical) (BBI-43830002) Sampling tube for manual sampler (classical) (BBI-43830004) Screw cap GL 25 with hole (for manual sampler) (BBI-44130456)
Description: <ul style="list-style-type: none"> • For sampling from the culture vessel • Part of manual sampler (classical) [BBI-43830002] • 3 hose nozzles in the cover for the sampling tubing from the culture vessel , for the sampling outlet and for the syringe 	



To the Shop:



Alle / Verkaufsartikel / Accessories / Addition / Headpieces

Headpiece with 2 hose nozzles 4 x 1 mm



bbi Scancode	BBI-44130400
Manufacturer	bbi-biotech GmbH
Material Certificate	3.1
Country of Origin	DE 
HS-Code	73269098
Weight	0.04 kg
Material	Stainless steel 316L

Components	1x headpiece
Related Products	<p>Headpiece with 2 hose nozzles 4 x 1 mm and 1 x Inoculation port with septum (BBI-44130443)</p> <p>Headpiece with 2 hose nozzles 4 x 1 mm and 1 x Pg 13,5 port (BBI-44130440)</p> <p>Headpiece with 4 hose nozzles 4 x 1 mm (BBI-44130406)</p>
<p>Description:</p> <ul style="list-style-type: none"> • Headpiece with 2 hose nozzles 4 x 1 mm for reservoir bottles with GL 45-thread • Connection system made of stainless steel • For use with screw cap GL 45 with hole and seal (available separately) • Hose olives: Outer diameter x wall thickness = 4 x 1 mm 	



Alle / Verkaufsartikel / Accessories / Addition / Headpieces

Headpiece with 2 hose nozzles 8 x 1 mm



bbi Scancode	BBI-44130401
Manufacturer	bbi-biotech GmbH
Material Certificate	3.1
Country of Origin	DE 
HS-Code	73269098
Weight	0.04 kg
Material	Stainless steel 316L

Components	1x headpiece
Related Products	Headpiece with 2 hose nozzles 6 x 1 mm (BBI-44130414) Headpiece with 2 hose nozzles 6 x 1 mm, 8 x 1 mm (BBI-44130415) Headpiece with 3 hose nozzles 6 x 1 mm (BBI-44130402)
Description: <ul style="list-style-type: none"> • Headpiece with 2 hose nozzles 8 x 1 mm for reservoir bottles with GL 45-thread • Connection system made of stainless steel • For use with screw cap GL 45 with hole and seal (available separately) • Hose olives: Outer diameter x wall thickness = 8 x 1 mm • Screw cap and seal available separately 	



To the Shop:



Alle / Verkaufsartikel / Accessories / Addition / Headpieces

Headpiece with 3 hose nozzles 6 x 1 mm



bbi Scancode	BBI-44130402
Manufacturer	bbi-biotech GmbH
Material Certificate	3.1
Country of Origin	DE 
HS-Code	73269098
Weight	0.05 kg
Material	Stainless steel 316L

Components	1x headpiece
Related Products	2 l laboratory bottle GL 45 with gasket and screw cap with hole (BBI-44130578) Headpiece with 3 hose nozzles 2x 6 x 1 mm, 1x 4 x 1 mm (BBI-44130412) Headpiece with 3 hose nozzles 4 x 1 mm and 1 x Pg 13,5 port (BBI-44130441)
Description: <ul style="list-style-type: none"> • Headpiece with 3 hose nozzles 6 x 1 mm for reservoir bottles with GL 45-thread • Connection system made of stainless steel • For use with screw cap GL 45 with hole and seal (available separately) • Hose olives: Outer diameter x wall thickness = 6 x 1 mm 	



To the Shop:



Alle / Verkaufsartikel / Accessories / Addition / Headpieces

Headpiece with 5 hose nozzles 4 x 1 mm



bbi Scancode	BBI-44130404
Manufacturer	bbi-biotech GmbH
Material Certificate	3.1
Country of Origin	DE 
HS-Code	73269098
Weight	0.05 kg
Material	Stainless steel 316L

Components	1x headpiece
Related Products	Headpiece with 4 hose nozzles 4 x 1 mm (BBI-44130406) Headpiece with 4 hose nozzles 4 x 1 mm and 1 x Pg 13,5 port (BBI-44130442) Headpiece with 5 hose nozzles 4 x 1 mm and 1 x Inoculation port with septum (BBI-44130446)
Description: <ul style="list-style-type: none"> • Headpiece with 5 hose nozzles 4 x 1 mm for reservoir bottles with GL 45-thread • Connection system made of stainless steel • For use with screw cap GL 45 with hole and seal (available separately) • Hose olives: Outer diameter x wall thickness = 4 x 1 mm 	



To the Shop:



Alle / Verkaufsartikel / Accessories / Addition / Headpieces

Headpiece for aerosolfree sampling with sterile screwfitting



bbi Scancode	BBI-44130405
Manufacturer	bbi-biotech GmbH
Internal Thread	GL 45
Material Certificate	3.1
Country of Origin	DE 
HS-Code	84818087
Material	Stainless steel 316L

Components	1x headpiece with valve and connections; 1x screw cap GL 45 with hole; 1x filter [BBI-44130510]; 1x tube [BBI-44130602]; 1x seal [BBI-44130451]
Consumables	Sterile filter 30 mm 0.2 µm (package of 10 pieces) (BBI-44130510) Seal for screw cap GL 45 (package of 10 pieces) (BBI-44130451) Silicone tube 3.2 x 1.6 mm (package with 5 m) (BBI-44130605)
Related Products	2 L laboratory bottle with DIN thread, GL 45 (BBI-44130564) Headpiece for aerosolfree sampling with Tri-clamp (BBI-44130408) Headpiece with 2 hose nozzles 4 x 1 mm and 1 x Inoculation port with septum (BBI-44130443)

Description:

- Aerosolfree sampling from a bioreactor
- For sampling bottle with GL 45 thread
- Head plate with membrane valve and connection to sampling valve (on top)
- Connection for steam supply (sideways)
- Valve unit and connections can be sterilized
- Standard: DN 6
- Also available with Tri-Clamp-connection
- Other connections on demand



To the Shop:



Alle / Verkaufsartikel / Accessories / Addition / Headpieces

Headpiece with 4 hose nozzles 4 x 1 mm



bbi Scancode	BBI-44130406
Manufacturer	bbi-biotech GmbH
Material Certificate	3.1
Country of Origin	DE 
HS-Code	73269098
Weight	0.04 kg
Material	Stainless steel 316L

Components	1x headpiece
Related Products	5 l laboratory bottle GL 45 with gasket and screw cap with hole (BBI-44130579) Headpiece with 4 hose nozzles 4 x 1 mm and 1 x Inoculation port with septum (BBI-44130445) Headpiece with 4 hose nozzles 6 x 1 mm (BBI-44130416)
Description: <ul style="list-style-type: none"> • Headpiece with 4 hose nozzles 4 x 1 mm for reservoir bottles with GL 45-thread • Connection system made of stainless steel • For use with screw cap GL 45 with hole and seal (available separately) • Hose olives: Outer diameter x wall thickness = 4 x 1 mm 	



To the Shop:



Alle / Verkaufsartikel / Accessories / Addition / Headpieces

Headpiece with 2 angled hose nozzles 6 x 1 mm



bbi Scancode	BBI-44130407
Manufacturer	bbi-biotech GmbH
Material Certificate	3.1
Country of Origin	DE 
HS-Code	73269098
Weight	0.04 kg
Material	Stainless steel 316L

Components	1x headpiece
Related Products	<p>Headpiece with 2 hose nozzles 6 x 1 mm (BBI-44130414)</p> <p>Headpiece with 2 hose nozzles 6 x 1 mm, 4 x 1 mm (BBI-44130413)</p> <p>Headpiece with 2 hose nozzles 6 x 1 mm, 8 x 1 mm (BBI-44130415)</p>
<p>Description:</p> <ul style="list-style-type: none"> • Headpiece with 2 hose nozzles 4x1 mm for reservoir bottles with GL 45-thread • Connection system made of stainless steel • For use with screw cap GL 45 with hole and seal (available separately) • Hose nozzles: Outer diameter x wall thickness = 6 x 1 mm 	



Alle / Verkaufsartikel / Accessories / Addition / Headpieces

Headpiece for aerosolfree sampling with Tri-clamp



bbi Scancode	BBI-44130408
Manufacturer	bbi-biotech GmbH
Internal Thread	GL 45
Material Certificate	3.1
Country of Origin	DE 
HS-Code	84818087
Weight	0.36 kg
Material	Stainless steel 316L

Components	1x headpiece with valve and connections; 1x screw cap GL 45 with hole; 1x filter [BBI-44130510]; 1x tube [BBI-44130602]; 1x seal [BBI-44130451]
Consumables	Silicone tube 3.2 x 1.6 mm (package with 5 m) (BBI-44130605) Sterile filter 30 mm 0.2 µm (package of 10 pieces) (BBI-44130510) Seal for screw cap GL 45 (package of 10 pieces) (BBI-44130451)
Related Products	2 L laboratory bottle with DIN thread, GL 45 (BBI-44130564) 5 L laboratory bottle with DIN thread, GL 45 (BBI-44130565) Headpiece for aerosolfree sampling with sterile screwfitting (BBI-44130405)

Description:

- Aerosolfree sampling from a bioreactor
- For sampling bottle with GL 45 thread
- Head plate with membrane valve and connection to sampling valve (on top) with triclamp D25
- Connection for steam outlet / condensate (sideways)
- Valve unit and connections can be sterilized
- Standard: DN6
- Also available with sterile screwfitting
- Other connections on demand



Alle / Verkaufsartikel / Accessories / Addition / Headpieces

Headpiece with 3 hose nozzles 4 x 1 mm



bbi Scancode	BBI-44130410
Manufacturer	bbi-biotech GmbH
Material Certificate	3.1
Country of Origin	DE 
HS-Code	73269098
Weight	0.04 kg
Material	Stainless steel 316L

Components	1x headpiece
Related Products	Headpiece with 3 hose nozzles 2x 6 x 1 mm, 1x 4 x 1 mm (BBI-44130412) Headpiece with 3 hose nozzles 4 x 1 mm and 1 x Inoculation port with septum (BBI-44130444) Headpiece with 3 hose nozzles 4 x 1 mm and 1 x Pg 13,5 port (BBI-44130441)
<p>Description:</p> <ul style="list-style-type: none"> • Headpiece with 3 hose nozzles 4 x 1 mm for reservoir bottles with GL 45-thread • Connection system made of stainless steel • For use with screw cap GL 45 with hole and seal (available separately) • Hose olives: Outer diameter x wall thickness = 4 x 1 mm 	



Alle / Verkaufsartikel / Accessories / Addition / Headpieces

Headpiece with 3 hose nozzles 2x 6 x 1 mm, 1x 4 x 1 mm



bbi Scancode	BBI-44130412
Manufacturer	bbi-biotech GmbH
Material Certificate	3.1
Country of Origin	DE 
HS-Code	73269098
Weight	0.04 kg
Material	Stainless steel 316L

Components	1x headpiece
Related Products	Headpiece with 3 hose nozzles 4 x 1 mm (BBI-44130410) Headpiece with 3 hose nozzles 4 x 1 mm and 1 x Inoculation port with septum (BBI-44130444) Headpiece with 3 hose nozzles 4 x 1 mm and 1 x Pg 13,5 port (BBI-44130441)
Description: <ul style="list-style-type: none"> • Headpiece with 2 hose nozzle 6 x 1 mm and 1 hose nozzle 4 x 1 mm for reservoir bottles with GL 45-thread • Connection system made of stainless steel • For use with screw cap GL 45 with hole and seal (available separately) • Hose olives: Outer diameter x wall thickness = 6 x 1 mm and 4 x 1 mm 	



To the Shop:



Alle / Verkaufsartikel / Accessories / Addition / Headpieces

Headpiece with 2 hose nozzles 6 x 1 mm, 4 x 1 mm



bbi Scancode	BBI-44130413
Manufacturer	bbi-biotech GmbH
Material Certificate	3.1
Country of Origin	DE 
HS-Code	73269098
Weight	0.04 kg
Material	Stainless steel 316L

Components	1x headpiece
Related Products	<p>Headpiece with 2 hose nozzles 6 x 1 mm (BBI-44130414)</p> <p>Headpiece with 2 hose nozzles 6 x 1 mm, 8 x 1 mm (BBI-44130415)</p> <p>Headpiece with 2 hose nozzles 8 x 1 mm (BBI-44130401)</p>
<p>Description:</p> <ul style="list-style-type: none"> • Headpiece with 1 hose nozzle 6 x 1 mm and 1 hose nozzle 4 x 1 mm for reservoir bottles with GL 45-thread • Connection system made of stainless steel • For use with screw cap GL 45 with hole and seal (available separately) • Hose olives: Outer diameter x wall thickness = 6 x 1 mm and 4 x 1 mm 	



Alle / Verkaufsartikel / Accessories / Addition / Headpieces

Headpiece with 2 hose nozzles 6 x 1 mm



bbi Scancode	BBI-44130414
Manufacturer	bbi-biotech GmbH
Material Certificate	3.1
Country of Origin	DE 
HS-Code	73269098
Weight	0.04 kg
Material	Stainless steel 316L

Components	1x headpiece
Related Products	<p>Headpiece with 2 hose nozzles 6 x 1 mm (BBI-44130414)</p> <p>Headpiece with 2 hose nozzles 6 x 1 mm, 4 x 1 mm (BBI-44130413)</p> <p>Headpiece with 2 hose nozzles 6 x 1 mm, 8 x 1 mm (BBI-44130415)</p>
<p>Description:</p> <ul style="list-style-type: none"> • Headpiece with 2 hose nozzles 6 x 1 mm for reservoir bottles with GL 45-thread • Connection system made of stainless steel • For use with screw cap GL 45 with hole and seal (available separately) • Hose olives: Outer diameter x wall thickness = 6 x 1 mm 	



Alle / Verkaufsartikel / Accessories / Addition / Headpieces

Headpiece with 2 hose nozzles 6 x 1 mm, 8 x 1 mm



bbi Scancode	BBI-44130415
Manufacturer	bbi-biotech GmbH
Material Certificate	3.1
Country of Origin	DE 
HS-Code	73269098
Weight	0.04 kg
Material	Stainless steel 316L

Components	1x headpiece
Related Products	<p>Headpiece with 2 hose nozzles 6 x 1 mm (BBI-44130414)</p> <p>Headpiece with 2 hose nozzles 6 x 1 mm, 4 x 1 mm (BBI-44130413)</p> <p>Headpiece with 3 hose nozzles 6 x 1 mm (BBI-44130402)</p>
<p>Description:</p> <ul style="list-style-type: none"> • Headpiece with 1 hose nozzle 6 x 1 mm and 1 hose nozzle 8 x 1 mm for reservoir bottles with GL 45-thread • Connection system made of stainless steel • For use with screw cap GL 45 with hole and seal (available separately) • Hose olives: Outer diameter x wall thickness = 6 x 1 mm and 8 x 1 mm 	



Alle / Verkaufsartikel / Accessories / Addition / Headpieces

Headpiece with 4 hose nozzles 6 x 1 mm



bbi Scancode	BBI-44130416
Manufacturer	bbi-biotech GmbH
Material Certificate	3.1
Country of Origin	DE 
HS-Code	73269098
Material	Stainless steel 316L

Components	1x headpiece
Related Products	Headpiece with 3 hose nozzles 6 x 1 mm (BBI-44130402) Headpiece with 4 hose nozzles 4 x 1 mm (BBI-44130406) Headpiece with 4 hose nozzles 4 x 1 mm and 1 x Pg 13,5 port (BBI-44130442)
Description: <ul style="list-style-type: none"> • Headpiece with 4 hose nozzles 6 x 1 mm for reservoir bottles with GL 45-thread • Connection system made of stainless steel • For use with screw cap GL 45 with hole and seal (available separately) • Hose olives: Outer diameter x wall thickness = 6 x 1 mm 	



To the Shop:



Alle / Verkaufsartikel / Accessories / Addition / Headpieces

Headpiece 1-1-1-4 with 0.25 L reservoir bottle GL 45



bbi Scancode	BBI-44130420
Manufacturer	bbi-biotech GmbH
Internal Thread	GL 45
External Thread	GL 45
Material Certificate	3.1, Rauigkeit, FDA
Country of Origin	DE 
HS-Code	73269098
Material	Stainless steel 316L silicone PBT

Components	1x Headpiece with 1x Pg 13.5 port, 1x pt100 casing, 1x microsparger M5, 4x hose nozzles 4 x 1 mm, 1x reservoir bottle 250 ml, 1x seal, 1x screw cap
Related Products	Headpiece 1-1-1-4 for 0.25 L media bottle GL 45 (1 x Pg 13,5, 1 x L sparger, 1 x harvest pipe fixed, 4 x hose nozzle) (BBI-44131012) Headpiece 1-1-1-4 for 0.25 L media bottle GL 45 (1 x Pg 13,5, 1 x L sparger, 1 x pT100 casing, 4 x hose nozzle) (BBI-44131018) Headpiece 1-1-1-4 for 0.25 L media bottle GL 45 (1 x Pg 13,5, 1 x microsparger M5, 1 x harvest pipe fixed, 4 x hose nozzle) (BBI-44131000)

Description:

- A reasonable reactor alternative for small scale experiments
- System is fully autoclavable
- Taking sterile samples, gassing, feeding and pH regulation possible

Kopfstück mit

- 1 x Pg 13.5 port port for standard 12 mm probes e.g. pH, pO₂, OD, bioPROBE
- 1 x pt100 casing
- 1 x microsparger M 5 with frit 20 µm
- 4 x hose nozzles 4 x 1 mm
- With matching 250 ml laboratory bottle GL 45 with seal and screw cap with hole



To the Shop:



Alle / Verkaufsartikel / Accessories / Addition / Headpieces

Headpiece 1-1-1-4 with 0.5 L reservoir bottle GL 45



bbi Scancode	BBI-44130421
Manufacturer	bbi-biotech GmbH
Internal Thread	GL 45
External Thread	GL 45
Material Certificate	3.1, Rauigkeit , FDA
Country of Origin	DE 
HS-Code	73269098
Material	Stainless steel 316L silicone PBT

Components	1x Headpiece with 1x Pg 13.5 port, 1x pt100 casing, 1x microsparger M5, 4x hose nozzles 4 x 1 mm, 1x reservoir bottle 500 ml, 1x seal, 1x screw cap
Related Products	Headpiece 1-1-1-4 for 0.5 L media bottle GL 45 (1 x Pg 13,5, 1 x L sparger, 1 x harvest pipe fixed, 4 x hose nozzle) (BBI-44131013) Headpiece 1-1-1-4 for 0.5 L media bottle GL 45 (1 x Pg 13,5, 1 x L sparger, 1 x pT100 casing, 4 x hose nozzle) (BBI-44131019) Headpiece 1-1-1-4 for 0.5 L media bottle GL 45 (1 x Pg 13,5, 1 x microsparger M5, 1 x harvest pipe fixed, 4 x hose nozzle) (BBI-44131001)

Description:

- A reasonable reactor alternative for small scale experiments
- System is fully autoclavable
- Taking sterile samples, gassing, feeding and pH regulation possible

Kopfstück mit

- 1 x Pg 13.5 port port for standard 12 mm probes e.g. pH , pO₂, OD, bioPROBE
- 1 x pt100 casing
- 1 x microsparger M 5 with frit 20 µm
- 4 x hose nozzles 4 x 1 mm
- With matching 500 ml laboratory bottle GL 45 with seal and screw cap with hole



To the Shop:



Alle / Verkaufsartikel / Accessories / Addition / Headpieces

Headpiece 1-1-1-4 with 1 L reservoir bottle GL 45



bbi Scancode	BBI-44130422
Manufacturer	bbi-biotech GmbH
Internal Thread	GL 45
External Thread	GL 45
Material Certificate	3.1, Rauigkeit, FDA
Country of Origin	DE 
HS-Code	73269098
Material	Stainless steel 316L silicone PBT

Components	1x Headpiece with 1x Pg 13.5 port, 1x pt100 casing, 1x microsparger M5, 4x hose nozzles 4 x 1 mm, 1x reservoir bottle 1 L, 1x seal, 1x screw cap
Related Products	Headpiece 1-1-1-4 for 1 L media bottle GL 45 (1 x Pg 13,5, 1 x L sparger, 1 x harvest pipe fixed, 4 x hose nozzle) (BBI-44131014) Headpiece 1-1-1-4 for 1 L media bottle GL 45 (1 x Pg 13,5, 1 x L sparger, 1 x pT100 casing, 4 x hose nozzle) (BBI-44131020) Headpiece 1-1-1-4 for 1 L media bottle GL 45 (1 x Pg 13,5, 1 x microsparger M5, 1 x harvest pipe fixed, 4 x hose nozzle) (BBI-44131002)

Description:

- A reasonable reactor alternative for small scale experiments
- System is fully autoclavable
- Taking sterile samples, gassing, feeding and pH regulation possible

Kopfstück mit

- 1 x Pg 13.5 port port for standard 12 mm probes e.g. pH, pO₂, OD, bioPROBE
- 1 x pt100 casing
- 1 x microsparger M 5 with frit 20 µm
- 4 x hose nozzles 4 x 1 mm
- With matching 1 L laboratory bottle GL 45 with seal and screw cap with hole



Alle / Verkaufsartikel / Accessories / Addition / Headpieces

Headpiece 1-1-1-4 with 2 L reservoir bottle GL 45



bbi Scancode	BBI-44130423
Manufacturer	bbi-biotech GmbH
Internal Thread	GL 45
External Thread	GL 45
Material Certificate	3.1, Rauigkeit, FDA
Country of Origin	DE 
HS-Code	73269098
Material	Stainless steel 316L silicone PBT

Components	1x Headpiece with 1x Pg 13.5 port, 1x pt100 casing, 1x microsparger G 1/8, 4x hose nozzles 4 x 1 mm, 1x reservoir bottle 2 L, 1x seal, 1x screw cap
Related Products	Headpiece 1-1-1-4 for 2 L media bottle GL 45 (1 x Pg 13,5, 1 x L sparger, 1 x harvest pipe fixed, 4 x hose nozzle) (BBI-44131015) Headpiece 1-1-1-4 for 2 L media bottle GL 45 (1 x Pg 13,5, 1 x microsparger M5, 1 x harvest pipe fixed, 4 x hose nozzle) (BBI-44131003) Headpiece 1-1-1-4 for 2 L media bottle GL 45 (1 x Pg 13,5, 1 x microsparger M5, 1 x pT100 casing, 4 x hose nozzle) (BBI-44131009)

Description:

- A reasonable reactor alternative for small scale experiments
- System is fully autoclavable
- Taking sterile samples, gassing, feeding and pH regulation possible

Kopfstück mit

- 1 x Pg 13.5 port port for standard 12 mm probes e.g. pH, pO₂, OD, bioPROBE
- 1 x pt100 casing
- 1 x microsparger G 1/8 with frit 20 µm
- 4 x hose nozzles 4 x 1 mm
- With matching 2 L laboratory bottle GL 45 with seal and screw cap with hole



To the Shop:



Alle / Verkaufsartikel / Accessories / Addition / Headpieces

Headpiece 1-1-1-4 with 5 L reservoir bottle GL 45



bbi Scancode	BBI-44130424
Manufacturer	bbi-biotech GmbH
Internal Thread	GL 45
External Thread	GL 45
Material Certificate	3.1, Rauigkeit, FDA
Country of Origin	DE 
HS-Code	73269098
Material	Stainless steel 316L silicone PBT

Components	1x Headpiece with 1x Pg 13.5 port, 1x pt100 casing, 1x microsparger G 1/8, 4x hose nozzles 4 x 1 mm, 1x reservoir bottle 5 L, 1x seal, 1x screw cap
Related Products	Headpiece 1-1-1-4 for 5 L media bottle GL 45 (1 x Pg 13,5, 1 x L sparger, 1 x harvest pipe fixed, 4 x hose nozzle) (BBI-44131016) Headpiece 1-1-1-4 for 5 L media bottle GL 45 (1 x Pg 13,5, 1 x L sparger, 1 x pT100 casing, 4 x hose nozzle) (BBI-44131022) Headpiece 1-1-1-4 for 5 L media bottle GL 45 (1 x Pg 13,5, 1 x microsparger M5, 1 x pT100 casing, 4 x hose nozzle) (BBI-44131010)

Description:

- A reasonable reactor alternative for small scale experiments
- System is fully autoclavable
- Taking sterile samples, gassing, feeding and pH regulation possible

Kopfstück mit

- 1 x Pg 13.5 port port for standard 12 mm probes e.g. pH, pO₂, OD, bioPROBE
- 1 x pt100 casing
- 1 x microsparger G 1/8 with frit 20 µm
- 4 x hose nozzles 4 x 1 mm
- With matching 5 L laboratory bottle GL 45 with seal and screw cap with hole



To the Shop:



Alle / Verkaufsartikel / Accessories / Addition / Headpieces

Headpiece 1-1-1-4 with 10 L reservoir bottle GL 45



bbi Scancode	BBI-44130425
Manufacturer	bbi-biotech GmbH
Internal Thread	GL 45
External Thread	GL 45
Material Certificate	3.1, Rauigkeit, FDA
Country of Origin	DE 
HS-Code	73269098
Material	Stainless steel 316L silicone PBT

Components	1x Headpiece with 1x Pg 13.5 port, 1x pt100 casing, 1x microsparger G 1/8, 4x hose nozzles 4 x 1 mm, 1x reservoir bottle 10 L, 1x seal, 1x screw cap
Related Products	Headpiece 1-1-1-4 for 10 L media bottle GL 45 (1 x Pg 13,5, 1 x L sparger, 1 x harvest pipe fixed, 4 x hose nozzle) (BBI-44131017) Headpiece 1-1-1-4 for 10 L media bottle GL 45 (1 x Pg 13,5, 1 x L sparger, 1 x pT100 casing, 4 x hose nozzle) (BBI-44131023) Headpiece 1-1-1-4 for 10 L media bottle GL 45 (1 x Pg 13,5, 1 x microsparger G 1/8, 1 x harvest pipe fixed, 4 x hose nozzle) (BBI-44131005)

Description:

- A reasonable reactor alternative for small scale experiments
- System is fully autoclavable
- Taking sterile samples, gassing, feeding and pH regulation possible

Kopfstück mit

- 1 x Pg 13.5 port port for standard 12 mm probes e.g. pH, pO₂, OD, bioPROBE
- 1 x pt100 casing
- 1 x microsparger G 1/8 with frit 20 µm
- 4 x hose nozzles 4 x 1 mm
- With matching 10 L laboratory bottle GL 45 with seal and screw cap with hole



To the Shop:



Alle / Verkaufsartikel / Accessories / Addition / Headpieces

Headpiece 3-1-3-4 with 0.5 L reservoir bottle GLS 80



bbi Scancode	BBI-44130431
Manufacturer	bbi-biotech GmbH
Internal Thread	GLS 80
External Thread	GLS 80
Material Certificate	3.1, Rauigkeit, FDA
Country of Origin	DE 
Material	Stainless steel 316L silicone PBT

Components	1x Headpiece with 3x Pg 13.5 port, 1x pt100 casing, 1x microsparger M 5, 1x dip tube; 1x inoculation port with septa, 4x hose nozzles 4 x 1 mm, 1x reservoir bottle 500 ml, 1x seal, 1x screw cap
Related Products	Headpiece 3-1-3-4 with 1 L reservoir bottle GLS 80 (BBI-44130432) Headpiece 3-1-3-4 with 10 L reservoir bottle GLS 80 (BBI-44130435) Headpiece 3-1-3-4 with 2 L reservoir bottle GLS 80 (BBI-44130433)

Description:

- A reasonable reactor alternative for small scale experiments
- System is fully autoclavable
- Taking sterile samples, gassing, feeding and pH regulation possible

Kopfstück mit

- 3 x Pg 13.5 port port for standard 12 mm probes e.g. pH, pO₂, OD, bioPROBE
- 1 x pt100 casing
- 1 x microsparger M 5 with frit 20 µm
- dip tube 6 x 1
- Inoculationport with septa
- 4 x hose nozzles 4 x 1 mm
- With matching 500 ml laboratory bottle GLS 80 with seal and screw cap with hole



To the Shop:



Alle / Verkaufsartikel / Accessories / Addition / Headpieces

Headpiece 3-1-3-4 with 1 L reservoir bottle GLS 80



bbi Scancode	BBI-44130432
Manufacturer	bbi-biotech GmbH
Internal Thread	GLS 80
External Thread	GLS 80
Material Certificate	3.1, Rauigkeit, FDA
Country of Origin	DE 
Material	Stainless steel 316L silicone PBT

Components	1x Headpiece with 3x Pg 13.5 port, 1x pt100 casing, 1x microsparger M 5, 1x dip tube; 1x inoculation port with septa, 4x hose nozzles 4 x 1 mm, 1x reservoir bottle 1 L, 1x seal, 1x screw cap
Related Products	Headpiece 3-1-3-4 with 0.5 L reservoir bottle GLS 80 (BBI-44130431) Headpiece 3-1-3-4 with 2 L reservoir bottle GLS 80 (BBI-44130433) Headpiece 3-1-3-4 with 5 L reservoir bottle GLS 80 (BBI-44130434)

Description:

- A reasonable reactor alternative for small scale experiments
- System is fully autoclavable
- Taking sterile samples, gassing, feeding and pH regulation possible

Kopfstück mit

- 3 x Pg 13.5 port port for standard 12 mm probes e.g. pH, pO₂, OD, bioPROBE
- 1 x pt100 casing
- 1 x microsparger M 5 with frit 20 µm
- 1x dip tube 6 x 1
- 1x inoculationport with septa
- 4 x hose nozzles 4 x 1 mm
- With matching 1 L laboratory bottle GLS 80 with seal and screw cap with hole



To the Shop:



Alle / Verkaufsartikel / Accessories / Addition / Headpieces

Headpiece 3-1-3-4 with 2 L reservoir bottle GLS 80



bbi Scancode	BBI-44130433
Manufacturer	bbi-biotech GmbH
Internal Thread	GLS 80
External Thread	GLS 80
Material Certificate	3.1, Rauigkeit, FDA
Country of Origin	DE 
HS-Code	73269098
Material	Stainless steel 316L silicone PBT

Components	1x Headpiece with 3x Pg 13.5 port, 1x pt100 casing, 1x microsparger M 5, 1x dip tube; 1x inoculation port with septa, 4x hose nozzles 4 x 1 mm, 1x reservoir bottle 2 L, 1x seal, 1x screw cap
Related Products	Headpiece 3-1-3-4 with 0.5 L reservoir bottle GLS 80 (BBI-44130431) Headpiece 3-1-3-4 with 1 L reservoir bottle GLS 80 (BBI-44130432) Headpiece 3-1-3-4 with 5 L reservoir bottle GLS 80 (BBI-44130434)

Description:

- A reasonable reactor alternative for small scale experiments
- System is fully autoclavable
- Taking sterile samples, gassing, feeding and pH regulation possible

Kopfstück mit

- 3 x Pg 13.5 port port for standard 12 mm probes e.g. pH, pO₂, OD, bioPROBE
- 1 x pt100 casing
- 1 x microsparger G 1/8 with frit 20 µm
- 1x dip tube 6 x 1
- 1x inoculationport with septa
- 4 x hose nozzles 4 x 1 mm
- With matching 2 L laboratory bottle GLS 80 with seal and screw cap with hole



To the Shop:



Alle / Verkaufsartikel / Accessories / Addition / Headpieces

Headpiece 3-1-3-4 with 5 L reservoir bottle GLS 80



bbi Scancode	BBI-44130434
Manufacturer	bbi-biotech GmbH
Internal Thread	GLS 80
External Thread	GLS 80
Material Certificate	3.1, Rauigkeit, FDA
Country of Origin	DE 
Material	Stainless steel 316L silicone PBT

Components	1x Headpiece with 3x Pg 13.5 port, 1x pt100 casing, 1x microsparger M 5, 1x dip tube; 1x inoculation port with septa, 4x hose nozzles 4 x 1 mm, 1x reservoir bottle 5 L, 1x seal, 1x screw cap
Related Products	Headpiece 3-1-3-4 with 1 L reservoir bottle GLS 80 (BBI-44130432) Headpiece 3-1-3-4 with 10 L reservoir bottle GLS 80 (BBI-44130435) Headpiece 3-1-3-4 with 2 L reservoir bottle GLS 80 (BBI-44130433)

Description:

- A reasonable reactor alternative for small scale experiments
- System is fully autoclavable
- Taking sterile samples, gassing, feeding and pH regulation possible

Kopfstück mit

- 3 x Pg 13.5 port port for standard 12 mm probes e.g. pH, pO₂, OD, bioPROBE
- 1 x pt100 casing
- 1 x microsparger G 1/8 with frit 20 µm
- 1x dip tube 6 x 1
- 1x inoculationport with septa
- 4 x hose nozzles 4 x 1 mm
- With matching 5 L laboratory bottle GLS 80 with seal and screw cap with hole



To the Shop:



Alle / Verkaufsartikel / Accessories / Addition / Headpieces

Headpiece 3-1-3-4 with 10 L reservoir bottle GLS 80



bbi Scancode	BBI-44130435
Manufacturer	bbi-biotech GmbH
Internal Thread	GLS 80
External Thread	GLS 80
Material Certificate	3.1, Rauigkeit, FDA
Country of Origin	DE 
Material	Stainless steel 316L silicone PBT

Components	1x Headpiece with 3x Pg 13.5 port, 1x pt100 casing, 1x microsparger M 5, 1x dip tube; 1x inoculation port with septa, 4x hose nozzles 4 x 1 mm, 1x reservoir bottle 10 L, 1x seal, 1x screw cap
Related Products	Headpiece 3-1-3-4 with 1 L reservoir bottle GLS 80 (BBI-44130432) Headpiece 3-1-3-4 with 2 L reservoir bottle GLS 80 (BBI-44130433) Headpiece 3-1-3-4 with 5 L reservoir bottle GLS 80 (BBI-44130434)

Description:

- A reasonable reactor alternative for small scale experiments
- System is fully autoclavable
- Taking sterile samples, gassing, feeding and pH regulation possible

Kopfstück mit

- 3 x Pg 13.5 port port for standard 12 mm probes e.g. pH, pO₂, OD, bioPROBE
- 1 x pt100 casing
- 1 x microsparger G 1/8 with frit 20 µm
- 1x dip tube 6 x 1
- 1x inoculationport with septa
- 4 x hose nozzles 4 x 1 mm
- With matching 10 L laboratory bottle GLS 80 with seal and screw cap with hole



To the Shop:



Alle / Verkaufsartikel / Accessories / Addition / Headpieces

Headpiece with 2 hose nozzles 4 x 1 mm and 1 x Pg 13,5 port



bbi Scancode	BBI-44130440
Manufacturer	bbi-biotech GmbH
Material Certificate	3.1, Rauigkeit
Country of Origin	DE 
Material	Stainless steel 316L

Components	1x headpiece
Related Products	<p>Headpiece with 2 hose nozzles 4 x 1 mm (BBI-44130400)</p> <p>Headpiece with 2 hose nozzles 4 x 1 mm and 1 x Inoculation port with septum (BBI-44130443)</p> <p>Headpiece with 4 hose nozzles 4 x 1 mm and 1 x Pg 13,5 port (BBI-44130442)</p>
<p>Description:</p> <ul style="list-style-type: none"> • A reasonable reactor alternative for small scale experiments • System is fully autoclavable <p>Kopfstück mit</p> <ul style="list-style-type: none"> • 1x Pg 13.5 port port for standard 12 mm probes e.g. pH , pO₂, OD, bioPROBE • 2x hose nozzles 4 x 1 mm • For GL 45 laboratory bottles (available separately) 	



Alle / Verkaufsartikel / Accessories / Addition / Headpieces

Headpiece with 3 hose nozzles 4 x 1 mm and 1 x Pg 13,5 port



bbi Scancode	BBI-44130441
Manufacturer	bbi-biotech GmbH
Material Certificate	3.1, Rauigkeit
Country of Origin	DE 
Material	Stainless steel 316L

Components	1x headpiece
Related Products	<p>Headpiece with 3 hose nozzles 4 x 1 mm (BBI-44130410)</p> <p>Headpiece with 3 hose nozzles 4 x 1 mm and 1 x Inoculation port with septum (BBI-44130444)</p> <p>Headpiece with 3 hose nozzles 6 x 1 mm (BBI-44130402)</p>
<p>Description:</p> <ul style="list-style-type: none"> • A reasonable reactor alternative for small scale experiments • System is fully autoclavable <p>Kopfstück mit</p> <ul style="list-style-type: none"> • 1x Pg 13.5 port port for standard 12 mm probes e.g. pH , pO₂, OD, bioPROBE • 3x hose nozzles 4 x 1 mm • For GL 45 laboratory bottles (available separately) 	



Alle / Verkaufsartikel / Accessories / Addition / Headpieces

Headpiece with 4 hose nozzles 4 x 1 mm and 1 x Pg 13,5 port



bbi Scancode	BBI-44130442
Manufacturer	bbi-biotech GmbH
Material Certificate	3.1, Rauigkeit
Country of Origin	DE 
Material	Stainless steel 316L

Components	1x headpiece
Related Products	Headpiece with 4 hose nozzles 4 x 1 mm (BBI-44130406) Headpiece with 4 hose nozzles 4 x 1 mm and 1 x Inoculation port with septum (BBI-44130445) Headpiece with 4 hose nozzles 6 x 1 mm (BBI-44130416)
Description: <ul style="list-style-type: none"> • A reasonable reactor alternative for small scale experiments • System is fully autoclavable <p>Kopfstück mit</p> <ul style="list-style-type: none"> • 1x Pg 13.5 port port for standard 12 mm probes e.g. pH , pO₂, OD, bioPROBE • 4x hose nozzles 4 x 1 mm • For GL 45 laboratory bottles (available separately) 	





To the Shop:

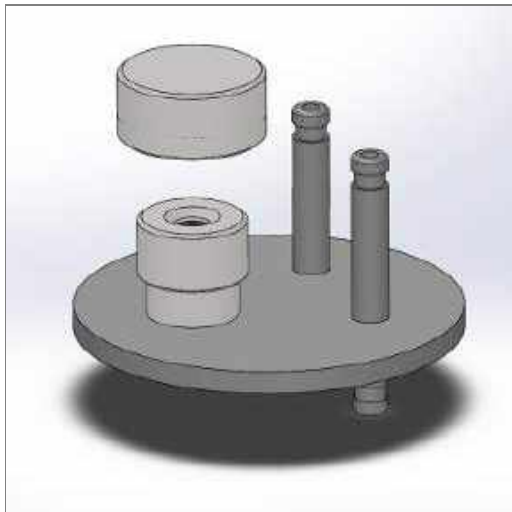

Alle / Verkaufsartikel / Accessories / Addition / Headpieces

Headpiece with 2 hose nozzles 4 x 1 mm and 1 x Inoculation port with septum



bbi Scancode	BBI-44130443
Manufacturer	bbi-biotech GmbH
Material Certificate	3.1, Rauigkeit
Country of Origin	DE 
Material	Stainless steel 316L EPDM black silicone

Components	1x headpiece
Related Products	Headpiece with 2 hose nozzles 4 x 1 mm (BBI-44130400) Headpiece with 2 hose nozzles 4 x 1 mm and 1 x Pg 13,5 port (BBI-44130440) Headpiece with 4 hose nozzles 4 x 1 mm and 1 x Inoculation port with septum (BBI-44130445)
<p>Description:</p> <ul style="list-style-type: none"> • A reasonable reactor alternative for small scale experiments • System is fully autoclavable <p>Kopfstück mit</p> <ul style="list-style-type: none"> • 1x inoculationport with septa • 2x hose nozzles 4 x 1 mm • For GL 45 laboratory bottles (available separately) 	



Alle / Verkaufsartikel / Accessories / Addition / Headpieces

Headpiece with 3 hose nozzles 4 x 1 mm and 1 x Inoculation port with septum



bbi Scancode	BBI-44130444
Manufacturer	bbi-biotech GmbH
Material Certificate	3.1, Rauigkeit
Country of Origin	DE 
Material	Stainless steel 316L EPDM black silicone

Components	1x headpiece
Related Products	Headpiece with 3 hose nozzles 2x 6 x 1 mm, 1x 4 x 1 mm (BBI-44130412) Headpiece with 3 hose nozzles 4 x 1 mm (BBI-44130410) Headpiece with 3 hose nozzles 4 x 1 mm and 1 x Pg 13,5 port (BBI-44130441)
<p>Description:</p> <ul style="list-style-type: none"> • A reasonable reactor alternative for small scale experiments • System is fully autoclavable <p>Kopfstück mit</p> <ul style="list-style-type: none"> • 1x inoculationport with septa • 3x hose nozzles 4 x 1 mm • For GL 45 laboratory bottles (available separately) 	



Alle / Verkaufsartikel / Accessories / Addition / Headpieces

Headpiece with 4 hose nozzles 4 x 1 mm and 1 x Inoculation port with septum



bbi Scancode	BBI-44130445
Manufacturer	bbi-biotech GmbH
Material Certificate	3.1, Rauigkeit
Country of Origin	DE 
Material	Stainless steel 316L EPDM black silicone

Components	1x headpiece
Related Products	5 l laboratory bottle GL 45 with gasket and screw cap with hole (BBI-44130579) Headpiece with 4 hose nozzles 4 x 1 mm (BBI-44130406) Headpiece with 4 hose nozzles 4 x 1 mm and 1 x Pg 13,5 port (BBI-44130442)
<p>Description:</p> <ul style="list-style-type: none"> • A reasonable reactor alternative for small scale experiments • System is fully autoclavable <p>Kopfstück mit</p> <ul style="list-style-type: none"> • 1x inoculationport with septa • 4x hose nozzles 4 x 1 mm • For GL 45 laboratory bottles (available separately) 	



To the Shop:



Alle / Verkaufsartikel / Accessories / Addition / Headpieces

Headpiece with 5 hose nozzles 4 x 1 mm and 1 x Inoculation port with septum



bbi Scancode	BBI-44130446
Manufacturer	bbi-biotech GmbH
Material Certificate	3.1, Rauigkeit
Country of Origin	DE 
Material	Stainless steel 316L EPDM black silicone

Components	1x headpiece
Related Products	Headpiece with 3 hose nozzles 4 x 1 mm and 1 x Inoculation port with septum (BBI-44130444) Headpiece with 4 hose nozzles 4 x 1 mm and 1 x Inoculation port with septum (BBI-44130445) Headpiece with 5 hose nozzles 4 x 1 mm (BBI-44130404)
<p>Description:</p> <ul style="list-style-type: none"> • A reasonable reactor alternative for small scale experiments • System is fully autoclavable <p>Kopfstück mit</p> <ul style="list-style-type: none"> • 1x inoculationport with septa • 5x hose nozzles 4 x 1 mm • For GL 45 laboratory bottles (available separately) 	



To the Shop:



Alle / Verkaufsartikel / Accessories / Addition / Headpieces

Headpiece for 10 L media bottle GLS 80 (3 x Pg 13,5, 1 x inoculation port (with septum), 1 x L-Sparger, 1 x Harvest pipe fixed, 1 x Pt100 sleeve, 4 x hose nozzle)



bbi Scancode

BBI-44130469

Components

Description:

Headpiece for 10 l media bottle GLS 80 with

- 3 x Pg 13,5
- 1 x inoculation port (with septum)
- 1 x L-Sparger
- 1 x Harvest pipe fixed
- 1 x Pt100 sleeve
- 4 x hose nozzle



Alle / Verkaufsartikel / Accessories / Addition / Headpieces

Headpiece 1-1-1-4 for 0.25 L media bottle GL 45 (1 x Pg 13,5, 1 x microsparger M5, 1 x harvest pipe fixed, 4 x hose nozzle)



bbi Scancode	BBI-44131000
Manufacturer	bbi-biotech GmbH
Material Certificate	3.1, Rauigkeit
Country of Origin	DE 
HS-Code	73269098
Material	Stainless steel 316L

Components	1x headpiece
Related Products	<p>Headpiece 1-1-1-4 for 0.25 L media bottle GL 45 (1 x Pg 13,5, 1 x L sparger, 1 x harvest pipe fixed, 4 x hose nozzle) (BBI-44131012)</p> <p>Headpiece 1-1-1-4 for 0.25 L media bottle GL 45 (1 x Pg 13,5, 1 x L sparger, 1 x pT100 casing, 4 x hose nozzle) (BBI-44131018)</p> <p>Headpiece 1-1-1-4 for 0.25 L media bottle GL 45 (1 x Pg 13,5, 1 x microsparger M5, 1 x pT100 casing, 4 x hose nozzle) (BBI-44131006)</p>

Description:

- A reasonable reactor alternative for small scale experiments
- System is fully autoclavable
- Taking sterile samples, gassing, feeding and pH regulation possible

Kopfstück mit

- 1 x Pg 13.5 port port for standard 12 mm probes e.g. pH, pO₂, OD, bioPROBE
- 1 x harvest pipe fix
- 1 x microsparger M 5 with frit 20 µm
- 4 x hose nozzles 4 x 1 mm
- Matching 250 ml laboratory bottle GL 45 with seal and screw cap with hole [BBI-44130575] available separately



To the Shop:



Alle / Verkaufsartikel / Accessories / Addition / Headpieces

Headpiece 1-1-1-4 for 0.5 L media bottle GL 45 (1 x Pg 13,5, 1 x microsparger M5, 1 x harvest pipe fixed, 4 x hose nozzle)



bbi Scancode	BBI-44131001
Manufacturer	bbi-biotech GmbH
Material Certificate	3.1, Rauigkeit
Country of Origin	DE 
HS-Code	73269098
Material	Stainless steel 316L

Components	1x headpiece
Related Products	Headpiece 1-1-1-4 for 0.5 L media bottle GL 45 (1 x Pg 13,5, 1 x L sparger, 1 x harvest pipe fixed, 4 x hose nozzle) (BBI-44131013) Headpiece 1-1-1-4 for 0.5 L media bottle GL 45 (1 x Pg 13,5, 1 x L sparger, 1 x pT100 casing, 4 x hose nozzle) (BBI-44131019) Headpiece 1-1-1-4 for 0.5 L media bottle GL 45 (1 x Pg 13,5, 1 x microsparger M5, 1 x pT100 casing, 4 x hose nozzle) (BBI-44131007)

Description:

- A reasonable reactor alternative for small scale experiments
- System is fully autoclavable
- Taking sterile samples, gassing, feeding and pH regulation possible

Kopfstück mit

- 1 x Pg 13.5 port port for standard 12 mm probes e.g. pH, pO₂, OD, bioPROBE
- 1 x harvest pipe fix
- 1 x microsparger M 5 with frit 20 µm
- 4 x hose nozzles 4 x 1 mm
- Matching 500 ml laboratory bottle GL 45 with seal and screw cap with hole [BBI-44130576] available separately



To the Shop:



Alle / Verkaufsartikel / Accessories / Addition / Headpieces

Headpiece 1-1-1-4 for 1 L media bottle GL 45 (1 x Pg 13,5, 1 x microsparger M5, 1 x harvest pipe fixed, 4 x hose nozzle)



bbi Scancode	BBI-44131002
Manufacturer	bbi-biotech GmbH
Material Certificate	3.1, Rauigkeit
Country of Origin	DE 
HS-Code	73269098
Material	Stainless steel 316L

Components	1x headpiece
Related Products	Headpiece 1-1-1-4 for 1 L media bottle GL 45 (1 x Pg 13,5, 1 x L sparger, 1 x harvest pipe fixed, 4 x hose nozzle) (BBI-44131014) Headpiece 1-1-1-4 for 1 L media bottle GL 45 (1 x Pg 13,5, 1 x L sparger, 1 x pT100 casing, 4 x hose nozzle) (BBI-44131020) Headpiece 1-1-1-4 for 1 L media bottle GL 45 (1 x Pg 13,5, 1 x microsparger M5, 1 x pT100 casing, 4 x hose nozzle) (BBI-44131008)

Description:

- A reasonable reactor alternative for small scale experiments
- System is fully autoclavable
- Taking sterile samples, gassing, feeding and pH regulation possible

Kopfstück mit

- 1 x Pg 13.5 port port for standard 12 mm probes e.g. pH, pO₂, OD, bioPROBE
- 1 x harvest pipe fix
- 1 x microsparger M 5 with frit 20 µm
- 4 x hose nozzles 4 x 1 mm
- Matching 1 L laboratory bottle GL 45 with seal and screw cap with hole [BBI-44130577] available separately



To the Shop:



Alle / Verkaufsartikel / Accessories / Addition / Headpieces

Headpiece 1-1-1-4 for 2 L media bottle GL 45 (1 x Pg 13,5, 1 x microsparger M5, 1 x harvest pipe fixed, 4 x hose nozzle)



bbi Scancode	BBI-44131003
Manufacturer	bbi-biotech GmbH
Material Certificate	3.1, Rauigkeit
Country of Origin	DE 
HS-Code	73269098
Material	Stainless steel 316L

Components	1x headpiece
Related Products	Headpiece 1-1-1-4 for 2 L media bottle GL 45 (1 x Pg 13,5, 1 x L sparger, 1 x harvest pipe fixed, 4 x hose nozzle) (BBI-44131015) Headpiece 1-1-1-4 for 2 L media bottle GL 45 (1 x Pg 13,5, 1 x L sparger, 1 x pT100 casing, 4 x hose nozzle) (BBI-44131021) Headpiece 1-1-1-4 for 2 L media bottle GL 45 (1 x Pg 13,5, 1 x microsparger M5, 1 x pT100 casing, 4 x hose nozzle) (BBI-44131009)

Description:

- A reasonable reactor alternative for small scale experiments
- System is fully autoclavable
- Taking sterile samples, gassing, feeding and pH regulation possible

Kopfstück mit

- 1 x Pg 13.5 port port for standard 12 mm probes e.g. pH, pO₂, OD, bioPROBE
- 1 x harvest pipe fix
- 1 x microsparger M 5 with frit 20 µm
- 4 x hose nozzles 4 x 1 mm
- Matching 2 L laboratory bottle GL 45 with seal and screw cap with hole [BBI-44130578] available separately



To the Shop:



Alle / Verkaufsartikel / Accessories / Addition / Headpieces

Headpiece 1-1-1-4 for 5 L media bottle GL 45 (1 x Pg 13,5, 1 x microsparger M5, 1 x harvest pipe fixed, 4 x hose nozzle)



bbi Scancode	BBI-44131004
Manufacturer	bbi-biotech GmbH
Material Certificate	3.1, Rauigkeit
Country of Origin	DE 
HS-Code	73269098
Material	Stainless steel 316L

Components	1x headpiece
Related Products	<p>Headpiece 1-1-1-4 for 5 L media bottle GL 45 (1 x Pg 13,5, 1 x L sparger, 1 x harvest pipe fixed, 4 x hose nozzle) (BBI-44131016)</p> <p>Headpiece 1-1-1-4 for 5 L media bottle GL 45 (1 x Pg 13,5, 1 x L sparger, 1 x pT100 casing, 4 x hose nozzle) (BBI-44131022)</p> <p>Headpiece 1-1-1-4 for 5 L media bottle GL 45 (1 x Pg 13,5, 1 x microsparger M5, 1 x pT100 casing, 4 x hose nozzle) (BBI-44131010)</p>

Description:

- A reasonable reactor alternative for small scale experiments
- System is fully autoclavable
- Taking sterile samples, gassing, feeding and pH regulation possible

Kopfstück mit

- 1 x Pg 13.5 port port for standard 12 mm probes e.g. pH , pO₂, OD, bioPROBE
- 1 x harvest pipe fix
- 1 x microsparger M 5 with frit 20 µm
- 4 x hose nozzles 4 x 1 mm
- Matching 5 L laboratory bottle GL 45 with seal and screw cap with hole [BBI-44130579] available separately



To the Shop:



Alle / Verkaufsartikel / Accessories / Addition / Headpieces

Headpiece 1-1-1-4 for 10 L media bottle GL 45 (1 x Pg 13,5, 1 x microsparger G 1/8, 1 x harvest pipe fixed, 4 x hose nozzle)



bbi Scancode	BBI-44131005
Manufacturer	bbi-biotech GmbH
Material Certificate	3.1, Rauigkeit
Country of Origin	DE 
HS-Code	73269098
Material	Stainless steel 316L

Components	1x headpiece
Related Products	Headpiece 1-1-1-4 for 10 L media bottle GL 45 (1 x Pg 13,5, 1 x L sparger, 1 x harvest pipe fixed, 4 x hose nozzle) (BBI-44131017) Headpiece 1-1-1-4 for 10 L media bottle GL 45 (1 x Pg 13,5, 1 x L sparger, 1 x pT100 casing, 4 x hose nozzle) (BBI-44131023) Headpiece 1-1-1-4 for 10 L media bottle GL 45 (1 x Pg 13,5, 1 x microsparger G 1/8, 1 x pT100 casing, 4 x hose nozzle) (BBI-44131011)

Description:

- A reasonable reactor alternative for small scale experiments
- System is fully autoclavable
- Taking sterile samples, gassing, feeding and pH regulation possible

Kopfstück mit

- 1 x Pg 13.5 port port for standard 12 mm probes e.g. pH, pO₂, OD, bioPROBE
- 1 x harvest pipe fix
- 1 x microsparger G 1/8 with frit 20 µm
- 4 x hose nozzles 4 x 1 mm
- Matching 10 L laboratory bottle GL 45 with seal and screw cap with hole [BBI-44130580] available separately



To the Shop:



Alle / Verkaufsartikel / Accessories / Addition / Headpieces

Headpiece 1-1-1-4 for 0.25 L media bottle GL 45 (1 x Pg 13,5, 1 x microsparger M5, 1 x pT100 casing, 4 x hose nozzle)



bbi Scancode	BBI-44131006
Manufacturer	bbi-biotech GmbH
Material Certificate	3.1, Rauigkeit
Country of Origin	DE 
HS-Code	73269098
Material	Stainless steel 316L

Components	1x headpiece
Related Products	<p>Headpiece 1-1-1-4 for 0.25 L media bottle GL 45 (1 x Pg 13,5, 1 x L sparger, 1 x harvest pipe fixed, 4 x hose nozzle) (BBI-44131012)</p> <p>Headpiece 1-1-1-4 for 0.25 L media bottle GL 45 (1 x Pg 13,5, 1 x L sparger, 1 x pT100 casing, 4 x hose nozzle) (BBI-44131018)</p> <p>Headpiece 1-1-1-4 for 0.25 L media bottle GL 45 (1 x Pg 13,5, 1 x microsparger M5, 1 x harvest pipe fixed, 4 x hose nozzle) (BBI-44131000)</p>

Description:

- A reasonable reactor alternative for small scale experiments
- System is fully autoclavable
- Taking sterile samples, gassing, feeding and pH regulation possible

Kopfstück mit

- 1 x Pg 13.5 port port for standard 12 mm probes e.g. pH, pO₂, OD, bioPROBE
- 1 x pt100 casing
- 1 x microsparger M 5 with frit 20 µm
- 4 x hose nozzles 4 x 1 mm
- Matching 250 ml laboratory bottle GL 45 with seal and screw cap with hole [BBI-44130575] available separately



To the Shop:



Alle / Verkaufsartikel / Accessories / Addition / Headpieces

Headpiece 1-1-1-4 for 0.5 L media bottle GL 45 (1 x Pg 13,5, 1 x microsparger M5, 1 x pT100 casing, 4 x hose nozzle)



bbi Scancode	BBI-44131007
Manufacturer	bbi-biotech GmbH
Material Certificate	3.1, Rauigkeit
Country of Origin	DE 
HS-Code	73269098
Material	Stainless steel 316L

Components	1x headpiece
Related Products	<p>Headpiece 1-1-1-4 for 0.5 L media bottle GL 45 (1 x Pg 13,5, 1 x L sparger, 1 x harvest pipe fixed, 4 x hose nozzle) (BBI-44131013)</p> <p>Headpiece 1-1-1-4 for 0.5 L media bottle GL 45 (1 x Pg 13,5, 1 x L sparger, 1 x pT100 casing, 4 x hose nozzle) (BBI-44131019)</p> <p>Headpiece 1-1-1-4 for 0.5 L media bottle GL 45 (1 x Pg 13,5, 1 x microsparger M5, 1 x harvest pipe fixed, 4 x hose nozzle) (BBI-44131001)</p>

Description:

- A reasonable reactor alternative for small scale experiments
- System is fully autoclavable
- Taking sterile samples, gassing, feeding and pH regulation possible

Kopfstück mit

- 1 x Pg 13.5 port port for standard 12 mm probes e.g. pH, pO₂, OD, bioPROBE
- 1 x pt100 casing
- 1 x microsparger M 5 with frit 20 µm
- 4 x hose nozzles 4 x 1 mm
- Matching 500 ml laboratory bottle GL 45 with seal and screw cap with hole [BBI-44130576] available separately



To the Shop:



Alle / Verkaufsartikel / Accessories / Addition / Headpieces

Headpiece 1-1-1-4 for 1 L media bottle GL 45 (1 x Pg 13,5, 1 x microsparger M5, 1 x pT100 casing, 4 x hose nozzle)



bbi Scancode	BBI-44131008
Manufacturer	bbi-biotech GmbH
Material Certificate	3.1, Rauigkeit
Country of Origin	DE 
HS-Code	73269098
Material	Stainless steel 316L

Components	1x headpiece
Related Products	Headpiece 1-1-1-4 for 1 L media bottle GL 45 (1 x Pg 13,5, 1 x L sparger, 1 x harvest pipe fixed, 4 x hose nozzle) (BBI-44131014) Headpiece 1-1-1-4 for 1 L media bottle GL 45 (1 x Pg 13,5, 1 x L sparger, 1 x pT100 casing, 4 x hose nozzle) (BBI-44131020) Headpiece 1-1-1-4 for 1 L media bottle GL 45 (1 x Pg 13,5, 1 x microsparger M5, 1 x harvest pipe fixed, 4 x hose nozzle) (BBI-44131002)

Description:

- A reasonable reactor alternative for small scale experiments
- System is fully autoclavable
- Taking sterile samples, gassing, feeding and pH regulation possible

Kopfstück mit

- 1 x Pg 13.5 port port for standard 12 mm probes e.g. pH, pO₂, OD, bioPROBE
- 1 x pt100 casing
- 1 x microsparger M 5 with frit 20 µm
- 4 x hose nozzles 4 x 1 mm
- Matching 1 L laboratory bottle GL 45 with seal and screw cap with hole [BBI-44130577] available separately



To the Shop:



Alle / Verkaufsartikel / Accessories / Addition / Headpieces

Headpiece 1-1-1-4 for 2 L media bottle GL 45 (1 x Pg 13,5, 1 x microsparger M5, 1 x pT100 casing, 4 x hose nozzle)



bbi Scancode	BBI-44131009
Manufacturer	bbi-biotech GmbH
Material Certificate	3.1, Rauigkeit
Country of Origin	DE 
HS-Code	73269098
Material	Stainless steel 316L

Components	1x headpiece
Related Products	Headpiece 1-1-1-4 for 2 L media bottle GL 45 (1 x Pg 13,5, 1 x L sparger, 1 x harvest pipe fixed, 4 x hose nozzle) (BBI-44131015) Headpiece 1-1-1-4 for 2 L media bottle GL 45 (1 x Pg 13,5, 1 x L sparger, 1 x pT100 casing, 4 x hose nozzle) (BBI-44131021) Headpiece 1-1-1-4 for 2 L media bottle GL 45 (1 x Pg 13,5, 1 x microsparger M5, 1 x harvest pipe fixed, 4 x hose nozzle) (BBI-44131003)

Description:

- A reasonable reactor alternative for small scale experiments
- System is fully autoclavable
- Taking sterile samples, gassing, feeding and pH regulation possible

Kopfstück mit

- 1 x Pg 13.5 port port for standard 12 mm probes e.g. pH, pO₂, OD, bioPROBE
- 1 x pt100 casing
- 1 x microsparger M 5 with frit 20 µm
- 4 x hose nozzles 4 x 1 mm
- Matching 2 L laboratory bottle GL 45 with seal and screw cap with hole [BBI-44130578] available separately



To the Shop:



Alle / Verkaufsartikel / Accessories / Addition / Headpieces

Headpiece 1-1-1-4 for 5 L media bottle GL 45 (1 x Pg 13,5, 1 x microsparger M5, 1 x pT100 casing, 4 x hose nozzle)



bbi Scancode	BBI-44131010
Manufacturer	bbi-biotech GmbH
Material Certificate	3.1, Rauigkeit
Country of Origin	DE 
HS-Code	73269098
Material	Stainless steel 316L

Components	1x headpiece
Related Products	Headpiece 1-1-1-4 for 5 L media bottle GL 45 (1 x Pg 13,5, 1 x L sparger, 1 x harvest pipe fixed, 4 x hose nozzle) (BBI-44131016) Headpiece 1-1-1-4 for 5 L media bottle GL 45 (1 x Pg 13,5, 1 x L sparger, 1 x pT100 casing, 4 x hose nozzle) (BBI-44131022) Headpiece 1-1-1-4 for 5 L media bottle GL 45 (1 x Pg 13,5, 1 x microsparger M5, 1 x harvest pipe fixed, 4 x hose nozzle) (BBI-44131004)

Description:

- A reasonable reactor alternative for small scale experiments
- System is fully autoclavable
- Taking sterile samples, gassing, feeding and pH regulation possible

Kopfstück mit

- 1 x Pg 13.5 port port for standard 12 mm probes e.g. pH, pO₂, OD, bioPROBE
- 1 x pt100 casing
- 1 x microsparger M 5 with frit 20 µm
- 4 x hose nozzles 4 x 1 mm
- Matching 5 L laboratory bottle GL 45 with seal and screw cap with hole [BBI-44130579] available separately



To the Shop:



Alle / Verkaufsartikel / Accessories / Addition / Headpieces

Headpiece 1-1-1-4 for 10 L media bottle GL 45 (1 x Pg 13,5, 1 x microsparger G 1/8, 1 x pT100 casing, 4 x hose nozzle)



bbi Scancode	BBI-44131011
Manufacturer	bbi-biotech GmbH
Material Certificate	3.1, Rauigkeit
Country of Origin	DE 
HS-Code	73269098
Material	Stainless steel 316L

Components	1x headpiece
Related Products	Headpiece 1-1-1-4 for 10 L media bottle GL 45 (1 x Pg 13,5, 1 x L sparger, 1 x harvest pipe fixed, 4 x hose nozzle) (BBI-44131017) Headpiece 1-1-1-4 for 10 L media bottle GL 45 (1 x Pg 13,5, 1 x L sparger, 1 x pT100 casing, 4 x hose nozzle) (BBI-44131023) Headpiece 1-1-1-4 for 10 L media bottle GL 45 (1 x Pg 13,5, 1 x microsparger G 1/8, 1 x harvest pipe fixed, 4 x hose nozzle) (BBI-44131005)

Description:

- A reasonable reactor alternative for small scale experiments
- System is fully autoclavable
- Taking sterile samples, gassing, feeding and pH regulation possible

Kopfstück mit

- 1 x Pg 13.5 port port for standard 12 mm probes e.g. pH, pO₂, OD, bioPROBE
- 1 x pt100 casing
- 1 x microsparger G 1/8 with frit 20 µm
- 4 x hose nozzles 4 x 1 mm
- Matching 10 L laboratory bottle GL 45 with seal and screw cap with hole [BBI-44130580] available separately



To the Shop:



Alle / Verkaufsartikel / Accessories / Addition / Headpieces

Headpiece 1-1-1-4 for 0.25 L media bottle GL 45 (1 x Pg 13,5, 1 x L sparger, 1 x harvest pipe fixed, 4 x hose nozzle)



bbi Scancode	BBI-44131012
Manufacturer	bbi-biotech GmbH
Material Certificate	3.1, Rauigkeit
Country of Origin	DE 
HS-Code	73269098
Material	Stainless steel 316L

Components	1x headpiece
Related Products	<p>Headpiece 1-1-1-4 for 0.25 L media bottle GL 45 (1 x Pg 13,5, 1 x L sparger, 1 x pT100 casing, 4 x hose nozzle) (BBI-44131018)</p> <p>Headpiece 1-1-1-4 for 0.25 L media bottle GL 45 (1 x Pg 13,5, 1 x microsparger M5, 1 x harvest pipe fixed, 4 x hose nozzle) (BBI-44131000)</p> <p>Headpiece 1-1-1-4 for 0.25 L media bottle GL 45 (1 x Pg 13,5, 1 x microsparger M5, 1 x pT100 casing, 4 x hose nozzle) (BBI-44131006)</p>

Description:

- A reasonable reactor alternative for small scale experiments
- System is fully autoclavable
- Taking sterile samples, gassing, feeding and pH regulation possible

Kopfstück mit

- 1 x Pg 13.5 port port for standard 12 mm probes e.g. pH , pO₂, OD, bioPROBE
- 1 x harvesting pipe fix
- 1 x L-sparger
- 4 x hose nozzles 4 x 1 mm
- Matching 250 ml laboratory bottle GL 45 with seal and screw cap with hole [BBI-44130575] available separately



To the Shop:



Alle / Verkaufsartikel / Accessories / Addition / Headpieces

Headpiece 1-1-1-4 for 0.5 L media bottle GL 45 (1 x Pg 13,5, 1 x L sparger, 1 x harvest pipe fixed, 4 x hose nozzle)



bbi Scancode	BBI-44131013
Manufacturer	bbi-biotech GmbH
Material Certificate	3.1, Rauigkeit
Country of Origin	DE 
HS-Code	73269098
Material	Stainless steel 316L

Components	1x headpiece
Related Products	<p>Headpiece 1-1-1-4 for 0.5 L media bottle GL 45 (1 x Pg 13,5, 1 x L sparger, 1 x pT100 casing, 4 x hose nozzle) (BBI-44131019)</p> <p>Headpiece 1-1-1-4 for 0.5 L media bottle GL 45 (1 x Pg 13,5, 1 x microsparger M5, 1 x harvest pipe fixed, 4 x hose nozzle) (BBI-44131001)</p> <p>Headpiece 1-1-1-4 for 0.5 L media bottle GL 45 (1 x Pg 13,5, 1 x microsparger M5, 1 x pT100 casing, 4 x hose nozzle) (BBI-44131007)</p>

Description:

- A reasonable reactor alternative for small scale experiments
- System is fully autoclavable
- Taking sterile samples, gassing, feeding and pH regulation possible

Kopfstück mit

- 1 x Pg 13.5 port port for standard 12 mm probes e.g. pH , pO₂, OD, bioPROBE
- 1 x harvesting pipe fix
- 1 x L-sparger
- 4 x hose nozzles 4 x 1 mm
- Matching 500 ml laboratory bottle GL 45 with seal and screw cap with hole [BBI-44130576] available separately



To the Shop:



Alle / Verkaufsartikel / Accessories / Addition / Headpieces

Headpiece 1-1-1-4 for 1 L media bottle GL 45 (1 x Pg 13,5, 1 x L sparger, 1 x harvest pipe fixed, 4 x hose nozzle)



bbi Scancode	BBI-44131014
Manufacturer	bbi-biotech GmbH
Material Certificate	3.1, Rauigkeit
Country of Origin	DE 
HS-Code	73269098
Material	Stainless steel 316L

Components	1x headpiece
Related Products	<p>Headpiece 1-1-1-4 for 1 L media bottle GL 45 (1 x Pg 13,5, 1 x L sparger, 1 x pT100 casing, 4 x hose nozzle) (BBI-44131020)</p> <p>Headpiece 1-1-1-4 for 1 L media bottle GL 45 (1 x Pg 13,5, 1 x microsparger M5, 1 x harvest pipe fixed, 4 x hose nozzle) (BBI-44131002)</p> <p>Headpiece 1-1-1-4 for 1 L media bottle GL 45 (1 x Pg 13,5, 1 x microsparger M5, 1 x pT100 casing, 4 x hose nozzle) (BBI-44131008)</p>

Description:

- A reasonable reactor alternative for small scale experiments
- System is fully autoclavable
- Taking sterile samples, gassing, feeding and pH regulation possible

Kopfstück mit

- 1 x Pg 13.5 port port for standard 12 mm probes e.g. pH , pO₂, OD, bioPROBE
- 1 x harvesting pipe fix
- 1 x L-sparger
- 4 x hose nozzles 4 x 1 mm
- Matching 1 L laboratory bottle GL 45 with seal and screw cap with hole [BBI-44130577] available separately



To the Shop:



Alle / Verkaufsartikel / Accessories / Addition / Headpieces

Headpiece 1-1-1-4 for 2 L media bottle GL 45 (1 x Pg 13,5, 1 x L sparger, 1 x harvest pipe fixed, 4 x hose nozzle)



bbi Scancode	BBI-44131015
Manufacturer	bbi-biotech GmbH
Material Certificate	3.1, Rauigkeit
Country of Origin	DE 
HS-Code	73269098
Material	Stainless steel 316L

Components	1x headpiece
Related Products	<p>Headpiece 1-1-1-4 for 2 L media bottle GL 45 (1 x Pg 13,5, 1 x L sparger, 1 x pT100 casing, 4 x hose nozzle) (BBI-44131021)</p> <p>Headpiece 1-1-1-4 for 2 L media bottle GL 45 (1 x Pg 13,5, 1 x microsparger M5, 1 x harvest pipe fixed, 4 x hose nozzle) (BBI-44131003)</p> <p>Headpiece 1-1-1-4 for 2 L media bottle GL 45 (1 x Pg 13,5, 1 x microsparger M5, 1 x pT100 casing, 4 x hose nozzle) (BBI-44131009)</p>

Description:

- A reasonable reactor alternative for small scale experiments
- System is fully autoclavable
- Taking sterile samples, gassing, feeding and pH regulation possible

Kopfstück mit

- 1 x Pg 13.5 port port for standard 12 mm probes e.g. pH , pO₂, OD, bioPROBE
- 1 x harvesting pipe fix
- 1 x L-sparger
- 4 x hose nozzles 4 x 1 mm
- Matching 2 L laboratory bottle GL 45 with seal and screw cap with hole [BBI-44130578] available separately



To the Shop:



Alle / Verkaufsartikel / Accessories / Addition / Headpieces

Headpiece 1-1-1-4 for 5 L media bottle GL 45 (1 x Pg 13,5, 1 x L sparger, 1 x harvest pipe fixed, 4 x hose nozzle)



bbi Scancode	BBI-44131016
Manufacturer	bbi-biotech GmbH
Material Certificate	3.1, Rauigkeit
Country of Origin	DE 
HS-Code	73269098
Material	Stainless steel 316L

Components	1x headpiece
Related Products	<p>Headpiece 1-1-1-4 for 5 L media bottle GL 45 (1 x Pg 13,5, 1 x L sparger, 1 x pT100 casing, 4 x hose nozzle) (BBI-44131022)</p> <p>Headpiece 1-1-1-4 for 5 L media bottle GL 45 (1 x Pg 13,5, 1 x microsparger M5, 1 x harvest pipe fixed, 4 x hose nozzle) (BBI-44131004)</p> <p>Headpiece 1-1-1-4 for 5 L media bottle GL 45 (1 x Pg 13,5, 1 x microsparger M5, 1 x pT100 casing, 4 x hose nozzle) (BBI-44131010)</p>

Description:

- A reasonable reactor alternative for small scale experiments
- System is fully autoclavable
- Taking sterile samples, gassing, feeding and pH regulation possible

Kopfstück mit

- 1 x Pg 13.5 port port for standard 12 mm probes e.g. pH, pO₂, OD, bioPROBE
- 1 x harvesting pipe fix
- 1 x L-sparger
- 4 x hose nozzles 4 x 1 mm
- Matching 5 L laboratory bottle GL 45 with seal and screw cap with hole [BBI-44130579] available separately



To the Shop:



Alle / Verkaufsartikel / Accessories / Addition / Headpieces

Headpiece 1-1-1-4 for 10 L media bottle GL 45 (1 x Pg 13,5, 1 x L sparger, 1 x harvest pipe fixed, 4 x hose nozzle)



bbi Scancode	BBI-44131017
Manufacturer	bbi-biotech GmbH
Material Certificate	3.1, Rauigkeit
Country of Origin	DE 
HS-Code	73269098
Material	Stainless steel 316L

Components	1x headpiece
Related Products	<p>Headpiece 1-1-1-4 for 10 L media bottle GL 45 (1 x Pg 13,5, 1 x L sparger, 1 x pT100 casing, 4 x hose nozzle) (BBI-44131023)</p> <p>Headpiece 1-1-1-4 for 10 L media bottle GL 45 (1 x Pg 13,5, 1 x microsparger G 1/8, 1 x harvest pipe fixed, 4 x hose nozzle) (BBI-44131005)</p> <p>Headpiece 1-1-1-4 for 10 L media bottle GL 45 (1 x Pg 13,5, 1 x microsparger G 1/8, 1 x pT100 casing, 4 x hose nozzle) (BBI-44131011)</p>

Description:

- A reasonable reactor alternative for small scale experiments
- System is fully autoclavable
- Taking sterile samples, gassing, feeding and pH regulation possible

Kopfstück mit

- 1 x Pg 13.5 port port for standard 12 mm probes e.g. pH , pO₂, OD, bioPROBE
- 1 x harvesting pipe fix
- 1 x L-sparger
- 4 x hose nozzles 4 x 1 mm
- Matching 10 L laboratory bottle GL 45 with seal and screw cap with hole [BBI-44130580] available separately



To the Shop:



Alle / Verkaufsartikel / Accessories / Addition / Headpieces

Headpiece 1-1-1-4 for 0.25 L media bottle GL 45 (1 x Pg 13,5, 1 x L sparger, 1 x pT100 casing, 4 x hose nozzle)



bbi Scancode	BBI-44131018
Manufacturer	bbi-biotech GmbH
Material Certificate	3.1, Rauigkeit
Country of Origin	DE 
HS-Code	73269098
Material	Stainless steel 316L

Components	1x headpiece
Related Products	<p>Headpiece 1-1-1-4 for 0.25 L media bottle GL 45 (1 x Pg 13,5, 1 x L sparger, 1 x harvest pipe fixed, 4 x hose nozzle) (BBI-44131012)</p> <p>Headpiece 1-1-1-4 for 0.25 L media bottle GL 45 (1 x Pg 13,5, 1 x microsparger M5, 1 x harvest pipe fixed, 4 x hose nozzle) (BBI-44131000)</p> <p>Headpiece 1-1-1-4 for 0.25 L media bottle GL 45 (1 x Pg 13,5, 1 x microsparger M5, 1 x pT100 casing, 4 x hose nozzle) (BBI-44131006)</p>

Description:

- A reasonable reactor alternative for small scale experiments
- System is fully autoclavable
- Taking sterile samples, gassing, feeding and pH regulation possible

Kopfstück mit

- 1 x Pg 13.5 port port for standard 12 mm probes e.g. pH, pO₂, OD, bioPROBE
- 1 x pt100 casing
- 1 x L-sparger
- 4 x hose nozzles 4 x 1 mm
- Matching 250 ml laboratory bottle GL 45 with seal and screw cap with hole [BBI-44130575] available separately



To the Shop:



Alle / Verkaufsartikel / Accessories / Addition / Headpieces

Headpiece 1-1-1-4 for 0.5 L media bottle GL 45 (1 x Pg 13,5, 1 x L sparger, 1 x pT100 casing, 4 x hose nozzle)



bbi Scancode	BBI-44131019
Manufacturer	bbi-biotech GmbH
Material Certificate	3.1, Rauigkeit
Country of Origin	DE 
HS-Code	73269098
Material	Stainless steel 316L

Components	1x headpiece
Related Products	<p>Headpiece 1-1-1-4 for 0.5 L media bottle GL 45 (1 x Pg 13,5, 1 x L sparger, 1 x harvest pipe fixed, 4 x hose nozzle) (BBI-44131013)</p> <p>Headpiece 1-1-1-4 for 0.5 L media bottle GL 45 (1 x Pg 13,5, 1 x microsparger M5, 1 x harvest pipe fixed, 4 x hose nozzle) (BBI-44131001)</p> <p>Headpiece 1-1-1-4 for 0.5 L media bottle GL 45 (1 x Pg 13,5, 1 x microsparger M5, 1 x pT100 casing, 4 x hose nozzle) (BBI-44131007)</p>

Description:

- A reasonable reactor alternative for small scale experiments
- System is fully autoclavable
- Taking sterile samples, gassing, feeding and pH regulation possible

Kopfstück mit

- 1 x Pg 13.5 port port for standard 12 mm probes e.g. pH , pO₂, OD, bioPROBE
- 1 x pt100 casing
- 1 x L-sparger
- 4 x hose nozzles 4 x 1 mm
- Matching 500 ml laboratory bottle GL 45 with seal and screw cap with hole [BBI-44130576] available separately



Alle / Verkaufsartikel / Accessories / Addition / Headpieces

Headpiece 1-1-1-4 for 1 L media bottle GL 45 (1 x Pg 13,5, 1 x L sparger, 1 x pT100 casing, 4 x hose nozzle)



bbi Scancode	BBI-44131020
Manufacturer	bbi-biotech GmbH
Material Certificate	3.1, Rauigkeit
Country of Origin	DE 
HS-Code	73269098
Material	Stainless steel 316L

Components	1x headpiece
Related Products	<p>Headpiece 1-1-1-4 for 1 L media bottle GL 45 (1 x Pg 13,5, 1 x L sparger, 1 x harvest pipe fixed, 4 x hose nozzle) (BBI-44131014)</p> <p>Headpiece 1-1-1-4 for 1 L media bottle GL 45 (1 x Pg 13,5, 1 x microsparger M5, 1 x harvest pipe fixed, 4 x hose nozzle) (BBI-44131002)</p> <p>Headpiece 1-1-1-4 for 1 L media bottle GL 45 (1 x Pg 13,5, 1 x microsparger M5, 1 x pT100 casing, 4 x hose nozzle) (BBI-44131008)</p>

Description:

- A reasonable reactor alternative for small scale experiments
- System is fully autoclavable
- Taking sterile samples, gassing, feeding and pH regulation possible

Kopfstück mit

- 1 x Pg 13.5 port port for standard 12 mm probes e.g. pH , pO₂, OD, bioPROBE
- 1 x pt100 casing
- 1 x L-sparger
- 4 x hose nozzles 4 x 1 mm
- Matching 1 L laboratory bottle GL 45 with seal and screw cap with hole [BBI-44130577] available separately



To the Shop:



Alle / Verkaufsartikel / Accessories / Addition / Headpieces

Headpiece 1-1-1-4 for 2 L media bottle GL 45 (1 x Pg 13,5, 1 x L sparger, 1 x pT100 casing, 4 x hose nozzle)



bbi Scancode	BBI-44131021
Manufacturer	bbi-biotech GmbH
Material Certificate	3.1, Rauigkeit
Country of Origin	DE 
HS-Code	73269098
Material	Stainless steel 316L

Components	1x headpiece
Related Products	<p>Headpiece 1-1-1-4 for 2 L media bottle GL 45 (1 x Pg 13,5, 1 x L sparger, 1 x harvest pipe fixed, 4 x hose nozzle) (BBI-44131015)</p> <p>Headpiece 1-1-1-4 for 2 L media bottle GL 45 (1 x Pg 13,5, 1 x microsparger M5, 1 x harvest pipe fixed, 4 x hose nozzle) (BBI-44131003)</p> <p>Headpiece 1-1-1-4 for 2 L media bottle GL 45 (1 x Pg 13,5, 1 x microsparger M5, 1 x pT100 casing, 4 x hose nozzle) (BBI-44131009)</p>

Description:

- A reasonable reactor alternative for small scale experiments
- System is fully autoclavable
- Taking sterile samples, gassing, feeding and pH regulation possible

Kopfstück mit

- 1 x Pg 13.5 port port for standard 12 mm probes e.g. pH , pO₂, OD, bioPROBE
- 1 x pt100 casing
- 1 x L-sparger
- 4 x hose nozzles 4 x 1 mm
- Matching 2 L laboratory bottle GL 45 with seal and screw cap with hole [BBI-44130578] available separately



To the Shop:



Alle / Verkaufsartikel / Accessories / Addition / Headpieces

Headpiece 1-1-1-4 for 5 L media bottle GL 45 (1 x Pg 13,5, 1 x L sparger, 1 x pT100 casing, 4 x hose nozzle)



bbi Scancode	BBI-44131022
Manufacturer	bbi-biotech GmbH
Material Certificate	3.1, Rauigkeit
Country of Origin	DE 
HS-Code	73269098
Material	Stainless steel 316L

Components	1x headpiece
Related Products	Headpiece 1-1-1-4 for 5 L media bottle GL 45 (1 x Pg 13,5, 1 x L sparger, 1 x harvest pipe fixed, 4 x hose nozzle) (BBI-44131016) Headpiece 1-1-1-4 for 5 L media bottle GL 45 (1 x Pg 13,5, 1 x microsparger M5, 1 x harvest pipe fixed, 4 x hose nozzle) (BBI-44131004) Headpiece 1-1-1-4 for 5 L media bottle GL 45 (1 x Pg 13,5, 1 x microsparger M5, 1 x pT100 casing, 4 x hose nozzle) (BBI-44131010)

Description:

- A reasonable reactor alternative for small scale experiments
- System is fully autoclavable
- Taking sterile samples, gassing, feeding and pH regulation possible

Kopfstück mit

- 1 x Pg 13.5 port port for standard 12 mm probes e.g. pH, pO₂, OD, bioPROBE
- 1 x pt100 casing
- 1 x L-sparger
- 4 x hose nozzles 4 x 1 mm
- Matching 5 L laboratory bottle GL 45 with seal and screw cap with hole [BBI-44130579] available separately



To the Shop:



Alle / Verkaufsartikel / Accessories / Addition / Headpieces

Headpiece 1-1-1-4 for 10 L media bottle GL 45 (1 x Pg 13,5, 1 x L sparger, 1 x pT100 casing, 4 x hose nozzle)



bbi Scancode	BBI-44131023
Manufacturer	bbi-biotech GmbH
Material Certificate	3.1, Rauigkeit
Country of Origin	DE 
HS-Code	73269098
Material	Stainless steel 316L

Components	1x headpiece
Related Products	<p>Headpiece 1-1-1-4 for 10 L media bottle GL 45 (1 x Pg 13,5, 1 x L sparger, 1 x harvest pipe fixed, 4 x hose nozzle) (BBI-44131017)</p> <p>Headpiece 1-1-1-4 for 10 L media bottle GL 45 (1 x Pg 13,5, 1 x microsparger G 1/8, 1 x harvest pipe fixed, 4 x hose nozzle) (BBI-44131005)</p> <p>Headpiece 1-1-1-4 for 10 L media bottle GL 45 (1 x Pg 13,5, 1 x microsparger G 1/8, 1 x pT100 casing, 4 x hose nozzle) (BBI-44131011)</p>

Description:

- A reasonable reactor alternative for small scale experiments
- System is fully autoclavable
- Taking sterile samples, gassing, feeding and pH regulation possible

Kopfstück mit

- 1 x Pg 13.5 port port for standard 12 mm probes e.g. pH, pO₂, OD, bioPROBE
- 1 x pt100 casing
- 1 x L-sparger
- 4 x hose nozzles 4 x 1 mm
- Matching 10 L laboratory bottle GL 45 with seal and screw cap with hole [BBI-44130580] available separately



To the Shop:



Alle / Verkaufsartikel / Accessories / Addition / Headpieces

Headpiece for Nalgene-83B bottles with 3 harvest pipes with Triclamp



bbi Scancode	BBI-44131024
Manufacturer	bbi-biotech GmbH
Material Certificate	3.1, Rauigkeit
Country of Origin	DE 
Material	Stainless steel 316L

Components	1x headpiece
Related Products	<p>Headpiece for 10 L media bottle GLS 80 (3 x Pg 13,5, 1 x inoculation port (with septum), 1 x L-Sparger, 1 x Harvest pipe fixed, 1 x Pt100 sleeve, 4 x hose nozzle) (BBI-44130469)</p> <p>Headpiece for 10 L media bottle GLS 80 (3 x Pg 13,5, 1 x inoculation port (with septum), 1 x Micro-Sparger, 1 x Harvest pipe fixed, 1 x Pt100 sleeve, 4 x hose nozzle) (BBI-44130484)</p> <p>Headpiece for aerosolfree sampling with Tri-clamp (BBI-44130408)</p>
Description: <ul style="list-style-type: none"> • Headpiece for Nalgene bottles (83B thread) with 3 harvest pipes • 2 x harvest pipe 360 mm (inside the bottle), ID 6 mm with Tri-Clamp 25 • 1 x harvest pipe 150 mm (inside the bottle) , ID 10 mm with Tri-Clamp 25 	



To the Shop:



Alle / Verkaufsartikel / Accessories / Addition / Media bottles

Magnetic stirrer MIXdrive 1 eco



bbi Scancode	BBI-43229001
Country of Origin	DE 

Components	1x magnetic stirrer
Related Products	Headpiece 1-1-1-4 with 2 L reservoir bottle GL 45 (BBI-44130423) Headpiece 3-1-3-4 with 2 L reservoir bottle GLS 80 (BBI-44130433) Headpiece 3-1-3-4 with 5 L reservoir bottle GLS 80 (BBI-44130434)
Description: For use with reservoir bottles with special headpieces	



To the Shop:



Alle / Verkaufsartikel / Accessories / Addition / Media bottles

Reservoir bottle 250 ml with 3 hose nozzles 4 x 1 mm



bbi Scancode	BBI-44130497
Manufacturer	bbi-biotech GmbH
Internal Thread	GL 45
External Thread	GL 45
Material Certificate	3.1, FDA
Country of Origin	DE 
HS-Code	70109079
Material	Stainless steel 316L borosilicate glass PBT silicone transparent

Components	1x glass bottle; 1x screw cap GL 45 with hole; 1x seal; 1x headpiece; 1x filter; 1x tube
Consumables	Silicone tube 3.2 x 1.6 mm (package with 5 m) (BBI-44130605) Headpiece with 3 hose nozzles 4 x 1 mm (BBI-44130410) Sterile filter 30 mm 0.2 µm (package of 10 pieces) (BBI-44130510) 250 ml laboratory bottle GL 45 with gasket and screw cap with hole (BBI-44130575)
Related Products	Headpiece with 3 hose nozzles 4 x 1 mm (BBI-44130410) Reservoir bottle 250 ml with 2 hose nozzles 4 x 1 mm (BBI-44130500) Reservoir bottle 250 ml with 4 hose nozzles 4 x 1 mm (BBI-44130503)

Description:

- For use with corrective solutions or substrates
- Autoclavable glass bottle made of borosilicate glass
- With headpiece made of stainless steel; with three hose nozzles for 3.2 x 1.6 mm hose
- With ventilation filter 0.2 µm
- The connection to the bioreactor is made via silicone hoses, which are attached to the hose olives of the respective head piece
- We also offer headpieces with more ports (please see category "headpieces")



To the Shop:



Alle / Verkaufsartikel / Accessories / Addition / Media bottles

Reservoir bottle 250 ml with 5 hose nozzles 4 x 1 mm



bbi Scancode	BBI-44130498
Manufacturer	bbi-biotech GmbH
Internal Thread	GL 45
External Thread	GL 45
Material Certificate	3.1, Rauigkeit, FDA
Country of Origin	DE 
HS-Code	70109079
Material	Stainless steel 316L borosilicate glass PBT silicone transparent

Components	1x glass bottle; 1x screw cap GL 45 with hole; 1x seal; 1x headpiece; 1x filter; 1x tube
Consumables	Headpiece with 5 hose nozzles 4 x 1 mm (BBI-44130404) Silicone tube 3.2 x 1.6 mm (package with 5 m) (BBI-44130605) Sterile filter 30 mm 0.2 µm (package of 10 pieces) (BBI-44130510) 250 ml laboratory bottle GL 45 with gasket and screw cap with hole (BBI-44130575)
Related Products	Headpiece with 5 hose nozzles 4 x 1 mm (BBI-44130404) Reservoir bottle 250 ml with 2 hose nozzles 4 x 1 mm (BBI-44130500) Reservoir bottle 250 ml with 4 hose nozzles 4 x 1 mm (BBI-44130503)

Description:

- For use with corrective solutions or substrates
- Autoclavable glass bottle made of borosilicate glass
- With headpiece made of stainless steel; with five hose nozzles for 3.2 x 1.6 mm hose
- With ventilation filter 0.2 µm
- The connection to the bioreactor is made via silicone hoses, which are attached to the hose olives of the respective head piece
- We also offer headpieces with more ports (please see category "headpieces")



To the Shop:



Alle / Verkaufsartikel / Accessories / Addition / Media bottles

Reservoir bottle 100 ml with 2 hose nozzles 4 x 1 mm



bbi Scancode	BBI-44130499
Manufacturer	bbi-biotech GmbH
Internal Thread	GL 45
External Thread	GL 45
Material Certificate	3.1, Rauigkeit, FDA
Country of Origin	DE 
HS-Code	70109079
Material	Stainless steel 316L borosilicate glass PBT silicone transparent

Components	1x glass bottle; 1x screw cap GL 45 with hole; 1x seal; 1x headpiece; 1x filter; 1x tube
Consumables	Silicone tube 3.2 x 1.6 mm (package with 5 m) (BBI-44130605) Sterile filter 30 mm 0.2 µm (package of 10 pieces) (BBI-44130510) 100 ml laboratory bottle GL 45 with gasket and screw cap with hole (BBI-44130574) Headpiece with 2 hose nozzles 4 x 1 mm (BBI-44130400)
Related Products	100 ml laboratory bottle GL 45 with gasket and screw cap with hole (BBI-44130574) 100 ml laboratory bottle with DIN thread, GL 45 (BBI-44130560) Headpiece with 2 hose nozzles 4 x 1 mm (BBI-44130400)

Description:

- For use with corrective solutions or substrates
- Autoclavable glass bottle made of borosilicate glass
- With headpiece made of stainless steel; with two hose nozzles for 3.2 x 1.6 mm hose
- With ventilation filter 0.2 µm
- The connection to the bioreactor is made via silicone hoses, which are attached to the hose olives of the respective head piece
- We also offer headpieces with more ports (please see category "headpieces")



To the Shop:



Alle / Verkaufsartikel / Accessories / Addition / Media bottles

Reservoir bottle 250 ml with 2 hose nozzles 4 x 1 mm



bbi Scancode	BBI-44130500
Manufacturer	bbi-biotech GmbH
Internal Thread	GL 45
External Thread	GL 45
Material Certificate	3.1, Rauigkeit, FDA
Country of Origin	DE 
HS-Code	70109079
Weight	0.26 kg
Material	Stainless steel 316L borosilicate glass PBT silicone transparent

Components	1x glass bottle; 1x screw cap GL 45 with hole; 1x seal; 1x headpiece; 1x filter; 1x tube
Consumables	Headpiece with 2 hose nozzles 4 x 1 mm (BBI-44130400) Silicone tube 3.2 x 1.6 mm (package with 5 m) (BBI-44130605) Sterile filter 30 mm 0.2 µm (package of 10 pieces) (BBI-44130510) 250 ml laboratory bottle GL 45 with gasket and screw cap with hole (BBI-44130575)
Related Products	Reservoir bottle 250 ml with 2 hose nozzles 6 x 1 mm (BBI-44131302) Reservoir bottle 250 ml with 4 hose nozzles 4 x 1 mm (BBI-44130503) Reservoir bottle 250 ml with 5 hose nozzles 4 x 1 mm (BBI-44130498)

Description:

- For use with corrective solutions or substrates
- Autoclavable glass bottle made of borosilicate glass
- With headpiece made of stainless steel; with two hose nozzles for 3.2 x 1.6 mm hose
- With ventilation filter 0.2 µm
- The connection to the bioreactor is made via silicone hoses, which are attached to the hose olives of the respective head piece
- We also offer headpieces with more ports (please see category "headpieces")



To the Shop:



Alle / Verkaufsartikel / Accessories / Addition / Media bottles

Reservoir bottle 500 ml with 2 hose nozzles 4 x 1 mm



bbi Scancode	BBI-44130501
Manufacturer	bbi-biotech GmbH
Internal Thread	GL 45
External Thread	GL 45
Material Certificate	3.1, Rauigkeit, FDA
Country of Origin	DE 
HS-Code	70109079
Material	Stainless steel 316L borosilicate glass PBT silicone transparent

Components	1x glass bottle; 1x screw cap GL 45 with hole; 1x seal; 1x headpiece; 1x filter; 1x tube
Consumables	Headpiece with 2 hose nozzles 4 x 1 mm (BBI-44130400) Sterile filter 30 mm 0.2 µm (package of 10 pieces) (BBI-44130510) Silicone tube 3.2 x 1.6 mm (package with 5 m) (BBI-44130605) 500 ml laboratory bottle GL 45 with gasket and screw cap with hole (BBI-44130576)
Related Products	Reservoir bottle 250 ml with 2 hose nozzles 4 x 1 mm (BBI-44130500) Reservoir bottle 500 ml with 2 hose nozzles 6 x 1 mm (BBI-44131303) Reservoir bottle 500 ml with 4 hose nozzles 4 x 1 mm (BBI-44130504)

Description:

- For use with corrective solutions or substrates
- Autoclavable glass bottle made of borosilicate glass
- With headpiece made of stainless steel; with two hose nozzles for 3.2 x 1.6 mm hose
- With ventilation filter 0.2 µm
- The connection to the bioreactor is made via silicone hoses, which are attached to the hose olives of the respective head piece
- We also offer headpieces with more ports (please see category "headpieces")



To the Shop:



Alle / Verkaufsartikel / Accessories / Addition / Media bottles

Reservoir bottle 1 L with 2 hose nozzles 4 x 1 mm



bbi Scancode	BBI-44130502
Manufacturer	bbi-biotech GmbH
Internal Thread	GL 45
External Thread	GL 45
Material Certificate	3.1, Rauigkeit, FDA
Country of Origin	DE 
HS-Code	70109079
Weight	0.35 kg
Material	Stainless steel 316L borosilicate glass PBT silicone transparent

Components	1x glass bottle; 1x screw cap GL 45 with hole; 1x seal; 1x headpiece; 1x filter; 1x tube
Consumables	Headpiece with 2 hose nozzles 4 x 1 mm (BBI-44130400) Silicone tube 3.2 x 1.6 mm (package with 5 m) (BBI-44130605) Sterile filter 30 mm 0.2 µm (package of 10 pieces) (BBI-44130510) 1 l laboratory bottle GL 45 with gasket and screw cap with hole (BBI-44130577)
Related Products	1 L laboratory bottle with DIN thread, GL 45 (BBI-44130563) Reservoir bottle 1 L with 2 hose nozzles 6 x 1 mm (BBI-44131304) Reservoir bottle 1 L with 4 hose nozzles 4 x 1 mm (BBI-44130505)

Description:

- For use with corrective solutions or substrates
- Autoclavable glass bottle made of borosilicate glass
- With headpiece made of stainless steel; with two hose nozzles for 3.2 x 1.6 mm hose
- With ventilation filter 0.2 µm
- The connection to the bioreactor is made via silicone hoses, which are attached to the hose olives of the respective head piece
- We also offer headpieces with more ports (please see category "headpieces")



To the Shop:



Alle / Verkaufsartikel / Accessories / Addition / Media bottles

Reservoir bottle 250 ml with 4 hose nozzles 4 x 1 mm



bbi Scancode	BBI-44130503
Manufacturer	bbi-biotech GmbH
Internal Thread	GL 45
External Thread	GL 45
Material Certificate	3.1, Rauigkeit, FDA
Country of Origin	DE 
HS-Code	70109079
Material	Stainless steel 316L borosilicate glass PBT silicone transparent

Components	1x glass bottle; 1x screw cap GL 45 with hole; 1x seal; 1x headpiece; 1x filter; 1x tube
Consumables	Headpiece with 4 hose nozzles 4 x 1 mm (BBI-44130406) Silicone tube 3.2 x 1.6 mm (package with 5 m) (BBI-44130605) Sterile filter 30 mm 0.2 µm (package of 10 pieces) (BBI-44130510) 250 ml laboratory bottle GL 45 with gasket and screw cap with hole (BBI-44130575)
Related Products	Headpiece with 4 hose nozzles 4 x 1 mm (BBI-44130406) Reservoir bottle 250 ml with 2 hose nozzles 4 x 1 mm (BBI-44130500) Reservoir bottle 250 ml with 5 hose nozzles 4 x 1 mm (BBI-44130498)

Description:

- For use with corrective solutions or substrates
- Autoclavable glass bottle made of borosilicate glass
- With headpiece made of stainless steel; with four hose nozzles for 3.2 x 1.6 mm hose
- With ventilation filter 0.2 µm
- The connection to the bioreactor is made via silicone hoses, which are attached to the hose olives of the respective head piece
- We also offer headpieces with more ports (please see category "headpieces")



To the Shop:



Alle / Verkaufsartikel / Accessories / Addition / Media bottles

Reservoir bottle 500 ml with 4 hose nozzles 4 x 1 mm



bbi Scancode	BBI-44130504
Manufacturer	bbi-biotech GmbH
Internal Thread	GL 45
External Thread	GL 45
Material Certificate	3.1, Rauigkeit, FDA
Country of Origin	DE 
HS-Code	70109079
Material	Stainless steel 316L borosilicate glass PBT silicone transparent

Components	1x glass bottle; 1x screw cap GL 45 with hole; 1x seal; 1x headpiece; 1x filter; 1x tube
Consumables	Headpiece with 4 hose nozzles 4 x 1 mm (BBI-44130406) Sterile filter 30 mm 0.2 µm (package of 10 pieces) (BBI-44130510) Silicone tube 3.2 x 1.6 mm (package with 5 m) (BBI-44130605) 500 ml laboratory bottle GL 45 with gasket and screw cap with hole (BBI-44130576)
Related Products	Reservoir bottle 250 ml with 4 hose nozzles 4 x 1 mm (BBI-44130503) Reservoir bottle 500 ml with 2 hose nozzles 4 x 1 mm (BBI-44130501) Reservoir bottle 500 ml with 2 hose nozzles 6 x 1 mm (BBI-44131303)

Description:

- For use with corrective solutions or substrates
- Autoclavable glass bottle made of borosilicate glass
- With headpiece made of stainless steel; with four hose nozzles for 3.2 x 1.6 mm hose
- With ventilation filter 0.2 µm
- The connection to the bioreactor is made via silicone hoses, which are attached to the hose olives of the respective head piece
- We also offer headpieces with more ports (please see category "headpieces")



Alle / Verkaufsartikel / Accessories / Addition / Media bottles

Reservoir bottle 1 L with 4 hose nozzles 4 x 1 mm



bbi Scancode	BBI-44130505
Manufacturer	bbi-biotech GmbH
Internal Thread	GL 45
External Thread	GL 45
Material Certificate	3.1, Rauigkeit, FDA
Country of Origin	DE 
HS-Code	70109079
Material	Stainless steel 316L borosilicate glass PBT silicone transparent

Components	1x glass bottle; 1x screw cap GL 45 with hole; 1x seal; 1x headpiece; 1x filter; 1x tube
Consumables	Headpiece with 4 hose nozzles 4 x 1 mm (BBI-44130406) Silicone tube 3.2 x 1.6 mm (package with 5 m) (BBI-44130605) Sterile filter 30 mm 0.2 µm (package of 10 pieces) (BBI-44130510) 1 l laboratory bottle GL 45 with gasket and screw cap with hole (BBI-44130577)
Related Products	Headpiece with 4 hose nozzles 4 x 1 mm (BBI-44130406) Reservoir bottle 1 L with 2 hose nozzles 4 x 1 mm (BBI-44130502) Reservoir bottle 1 L with 2 hose nozzles 6 x 1 mm (BBI-44131304)

Description:

- For use with corrective solutions or substrates
- Autoclavable glass bottle made of borosilicate glass
- With headpiece made of stainless steel; with four hose nozzles for 3.2 x 1.6 mm hose
- With ventilation filter 0.2 µm
- The connection to the bioreactor is made via silicone hoses, which are attached to the hose olives of the respective head piece
- We also offer headpieces with more ports (please see category "headpieces")



To the Shop:



Alle / Verkaufsartikel / Accessories / Addition / Media bottles

Reservoir bottle 2 L with 2 hose nozzles 4 x 1 mm



bbi Scancode	BBI-44130506
Manufacturer	bbi-biotech GmbH
Internal Thread	GL 45
External Thread	GL 45
Material Certificate	3.1, Rauigkeit, FDA
Country of Origin	DE 
HS-Code	70109079
Weight	0.45 kg
Material	Stainless steel 316L borosilicate glass PBT silicone transparent

Components	1x glass bottle; 1x screw cap GL 45 with hole; 1x seal; 1x headpiece; 1x filter; 1x tube
Consumables	Silicone tube 3.2 x 1.6 mm (package with 5 m) (BBI-44130605) Sterile filter 30 mm 0.2 µm (package of 10 pieces) (BBI-44130510) Headpiece with 2 hose nozzles 4 x 1 mm (BBI-44130400) 2 l laboratory bottle GL 45 with gasket and screw cap with hole (BBI-44130578)
Related Products	Headpiece with 2 hose nozzles 4 x 1 mm (BBI-44130400) Reservoir bottle 1 L with 2 hose nozzles 4 x 1 mm (BBI-44130502) Reservoir bottle 2 L with 2 hose nozzles 6 x 1 mm (BBI-44131305)

Description:

- For use with corrective solutions or substrates
- Autoclavable glass bottle made of borosilicate glass
- With headpiece made of stainless steel; with two hose nozzles for 3.2 x 1.6 mm hose
- With ventilation filter 0.2 µm
- The connection to the bioreactor is made via silicone hoses, which are attached to the hose olives of the respective head piece
- We also offer headpieces with more ports (please see category "headpieces")



To the Shop:



Alle / Verkaufsartikel / Accessories / Addition / Media bottles

Reservoir bottle 2 L with 4 hose nozzles 4 x 1 mm



bbi Scancode	BBI-44130507
Manufacturer	bbi-biotech GmbH
Internal Thread	GL 45
External Thread	GL 45
Material Certificate	3.1, Rauigkeit, FDA
Country of Origin	DE 
HS-Code	70109079
Material	Stainless steel 316L borosilicate glass PBT silicone transparent

Components	1x glass bottle; 1x screw cap GL 45 with hole; 1x seal; 1x headpiece; 1x filter; 1x tube
Consumables	Headpiece with 4 hose nozzles 4 x 1 mm (BBI-44130406) Silicone tube 3.2 x 1.6 mm (package with 5 m) (BBI-44130605) Sterile filter 30 mm 0.2 µm (package of 10 pieces) (BBI-44130510) 2 l laboratory bottle GL 45 with gasket and screw cap with hole (BBI-44130578)
Related Products	Headpiece with 4 hose nozzles 4 x 1 mm (BBI-44130406) Reservoir bottle 2 L with 2 hose nozzles 4 x 1 mm (BBI-44130506) Reservoir bottle 2 L with 2 hose nozzles 6 x 1 mm (BBI-44131305)

Description:

- For use with corrective solutions or substrates
- Autoclavable glass bottle made of borosilicate glass
- With headpiece made of stainless steel; with four hose nozzles for 3.2 x 1.6 mm hose
- With ventilation filter 0.2 µm
- The connection to the bioreactor is made via silicone hoses, which are attached to the hose olives of the respective head piece
- We also offer headpieces with more ports (please see category "headpieces")



To the Shop:



Alle / Verkaufsartikel / Accessories / Addition / Media bottles

Reservoir bottle 5 L with 2 hose nozzles 4 x 1 mm



bbi Scancode	BBI-44130508
Manufacturer	bbi-biotech GmbH
Internal Thread	GL 45
External Thread	GL 45
Material Certificate	3.1, Rauigkeit, FDA
Country of Origin	DE 
HS-Code	70109079
Weight	1.82 kg
Material	Stainless steel 316L borosilicate glass PBT silicone transparent

Components	1x glass bottle; 1x screw cap GL 45 with hole; 1x seal; 1x headpiece; 1x filter; 1x tube
Consumables	Silicone tube 3.2 x 1.6 mm (package with 5 m) (BBI-44130605) Sterile filter 30 mm 0.2 µm (package of 10 pieces) (BBI-44130510) Headpiece with 2 hose nozzles 4 x 1 mm (BBI-44130400) 5 l laboratory bottle GL 45 with gasket and screw cap with hole (BBI-44130579)
Related Products	Headpiece with 2 hose nozzles 4 x 1 mm (BBI-44130400) Reservoir bottle 5 L with 2 hose nozzles 6 x 1 mm (BBI-44131306) Reservoir bottle 5 L with 4 hose nozzles 4 x 1 mm (BBI-44130509)

Description:

- For use with corrective solutions or substrates
- Autoclavable glass bottle made of borosilicate glass
- With headpiece made of stainless steel; with two hose nozzles for 3.2 x 1.6 mm hose
- With ventilation filter 0.2 µm
- The connection to the bioreactor is made via silicone hoses, which are attached to the hose olives of the respective head piece
- We also offer headpieces with more ports (please see category "headpieces")



To the Shop:



Alle / Verkaufsartikel / Accessories / Addition / Media bottles

Reservoir bottle 5 L with 4 hose nozzles 4 x 1 mm



bbi Scancode	BBI-44130509
Manufacturer	bbi-biotech GmbH
Internal Thread	GL 45
External Thread	GL 45
Material Certificate	3.1, Rauigkeit, FDA
Country of Origin	DE 
HS-Code	70109079
Material	Stainless steel 316L borosilicate glass PBT silicone transparent

Components	1x glass bottle; 1x screw cap GL 45 with hole; 1x seal; 1x headpiece; 1x filter; 1x tube
Consumables	Silicone tube 3.2 x 1.6 mm (package with 5 m) (BBI-44130605) Sterile filter 30 mm 0.2 µm (package of 10 pieces) (BBI-44130510) Headpiece with 4 hose nozzles 4 x 1 mm (BBI-44130406) 5 l laboratory bottle GL 45 with gasket and screw cap with hole (BBI-44130579)
Related Products	Headpiece with 4 hose nozzles 4 x 1 mm (BBI-44130406) Reservoir bottle 5 L with 2 hose nozzles 4 x 1 mm (BBI-44130508) Reservoir bottle 5 L with 2 hose nozzles 6 x 1 mm (BBI-44131306)

Description:

- For use with corrective solutions or substrates
- Autoclavable glass bottle made of borosilicate glass
- With headpiece made of stainless steel; with four hose nozzles for 3.2 x 1.6 mm hose
- With ventilation filter 0.2 µm
- The connection to the bioreactor is made via silicone hoses, which are attached to the hose olives of the respective head piece
- We also offer headpieces with more ports (please see category "headpieces")



To the Shop:



Alle / Verkaufsartikel / Accessories / Addition / Media bottles

Reservoir bottle 250 ml with 2 hose nozzles 6 x 1 mm



bbi Scancode	BBI-44131302
Manufacturer	bbi-biotech GmbH
Internal Thread	GL 45
External Thread	GL 45
Material Certificate	3.1, Rauigkeit, FDA
Country of Origin	DE 
HS-Code	70109079
Material	Stainless steel 316L silicone borosilicate glass PBT

Components	1x glass bottle; 1x screw cap GL 45 with hole; 1x seal; 1x headpiece; 1x filter; 1x tube
Related Products	Headpiece with 2 hose nozzles 6 x 1 mm (BBI-44130414) Reservoir bottle 250 ml with 2 hose nozzles 4 x 1 mm (BBI-44130500) Reservoir bottle 250 ml with 5 hose nozzles 4 x 1 mm (BBI-44130498)

Description:

- For use with corrective solutions or substrates
- Autoclavable glass bottle made of borosilicate glass
- With headpiece made of stainless steel; with two hose nozzles
- With ventilation filter 0.2 µm
- The connection to the bioreactor is made via silicone hoses, which are attached to the hose olives of the respective head piece
- We also offer headpieces with more ports (please see category "headpieces")



To the Shop:



Alle / Verkaufsartikel / Accessories / Addition / Media bottles

Reservoir bottle 500 ml with 2 hose nozzles 6 x 1 mm



bbi Scancode	BBI-44131303
Manufacturer	bbi-biotech GmbH
Internal Thread	GL 45
External Thread	GL 45
Material Certificate	3.1, Rauigkeit, FDA
Country of Origin	DE 
HS-Code	70109079
Material	Stainless steel 316L silicone borosilicate glass PBT

Components	1x glass bottle; 1x screw cap GL 45 with hole; 1x seal; 1x headpiece; 1x filter; 1x tube
Related Products	Reservoir bottle 250 ml with 2 hose nozzles 6 x 1 mm (BBI-44131302) Reservoir bottle 500 ml with 2 hose nozzles 4 x 1 mm (BBI-44130501) Reservoir bottle 500 ml with 4 hose nozzles 4 x 1 mm (BBI-44130504)

Description:

- For use with corrective solutions or substrates
- Autoclavable glass bottle made of borosilicate glass
- With headpiece made of stainless steel; with two hose nozzles
- With ventilation filter 0.2 µm
- The connection to the bioreactor is made via silicone hoses, which are attached to the hose olives of the respective head piece
- We also offer headpieces with more ports (please see category "headpieces")



To the Shop:



Alle / Verkaufsartikel / Accessories / Addition / Media bottles

Reservoir bottle 1 L with 2 hose nozzles 6 x 1 mm



bbi Scancode	BBI-44131304
Manufacturer	bbi-biotech GmbH
Internal Thread	GL 45
External Thread	GL 45
Material Certificate	3.1, FDA
Country of Origin	DE 
HS-Code	70109079
Material	Stainless steel 316L silicone borosilicate glass PBT

Components	1x glass bottle; 1x screw cap GL 45 with hole; 1x seal; 1x headpiece; 1x filter; 1x tube
Related Products	Headpiece with 2 hose nozzles 6 x 1 mm (BBI-44130414) Reservoir bottle 1 L with 2 hose nozzles 4 x 1 mm (BBI-44130502) Reservoir bottle 1 L with 4 hose nozzles 4 x 1 mm (BBI-44130505)

Description:

- For use with corrective solutions or substrates
- Autoclavable glass bottle made of borosilicate glass
- With headpiece made of stainless steel; with two hose nozzles
- With ventilation filter 0.2 µm
- The connection to the bioreactor is made via silicone hoses, which are attached to the hose olives of the respective head piece
- We also offer headpieces with more ports (please see category "headpieces")



Alle / Verkaufsartikel / Accessories / Addition / Media bottles

Reservoir bottle 2 L with 2 hose nozzles 6 x 1 mm



bbi Scancode	BBI-44131305
Manufacturer	bbi-biotech GmbH
Internal Thread	GL 45
External Thread	GL 45
Material Certificate	3.1, Rauigkeit, FDA
Country of Origin	DE 
HS-Code	70109079
Material	Stainless steel 316L silicone borosilicate glass PBT

Components	1x glass bottle; 1x screw cap GL 45 with hole; 1x seal; 1x headpiece; 1x filter; 1x tube
Related Products	Headpiece with 2 hose nozzles 6 x 1 mm (BBI-44130414) Reservoir bottle 2 L with 2 hose nozzles 4 x 1 mm (BBI-44130506) Reservoir bottle 2 L with 4 hose nozzles 4 x 1 mm (BBI-44130507)

Description:

- For use with corrective solutions or substrates
- Autoclavable glass bottle made of borosilicate glass
- With headpiece made of stainless steel; with two hose nozzles
- With ventilation filter 0.2 µm
- The connection to the bioreactor is made via silicone hoses, which are attached to the hose olives of the respective head piece
- We also offer headpieces with more ports (please see category "headpieces")



To the Shop:



Alle / Verkaufsartikel / Accessories / Addition / Media bottles

Reservoir bottle 5 L with 2 hose nozzles 6 x 1 mm



bbi Scancode	BBI-44131306
Manufacturer	bbi-biotech GmbH
Internal Thread	GL 45
External Thread	GL 45
Material Certificate	3.1, Rauigkeit, FDA
Country of Origin	DE 
HS-Code	70109079
Material	Stainless steel 316L silicone borosilicate glass PBT

Components	1x glass bottle; 1x screw cap GL 45 with hole; 1x seal; 1x headpiece; 1x filter; 1x tube
Related Products	Headpiece with 2 hose nozzles 6 x 1 mm (BBI-44130414) Reservoir bottle 5 L with 2 hose nozzles 4 x 1 mm (BBI-44130508) Reservoir bottle 5 L with 4 hose nozzles 4 x 1 mm (BBI-44130509)

Description:

- For use with corrective solutions or substrates
- Autoclavable glass bottle made of borosilicate glass
- With headpiece made of stainless steel; with two hose nozzles
- With ventilation filter 0.2 µm
- The connection to the bioreactor is made via silicone hoses, which are attached to the hose olives of the respective head piece
- We also offer headpieces with more ports (please see category "headpieces")



To the Shop:



Alle / Verkaufsartikel / Accessories / Addition / Laboratory bottles

100 ml laboratory bottle with DIN thread, GL 45



bbi Scancode	BBI-44130560
External Thread	GL 45
Country of Origin	DE 
HS-Code	70172000
Material	borosilicate glass

Components	1x laboratory bottle
Related Products	<p>100 ml laboratory bottle with DIN thread, GL 45, plastic coated (BBI-44130567)</p> <p>Screw cap GL 45 with hole (set: red, yellow, green, blue) (BBI-44130473)</p> <p>Seal for screw cap GL 45 (package of 10 pieces) (BBI-44130451)</p>
Description:	<ul style="list-style-type: none"> • Clear glass with graduation



Alle / Verkaufsartikel / Accessories / Addition / Laboratory bottles

250 ml laboratory bottle with DIN thread, GL 45



bbi Scancode	BBI-44130561
External Thread	GL 45
Country of Origin	DE 
HS-Code	70172000
Material	borosilicate glass

Components	1x laboratory bottle
Related Products	<p>250 ml laboratory bottle GL 45 with gasket and screw cap with hole (BBI-44130575)</p> <p>250 ml laboratory bottle with DIN thread, GL 45, plastic coated (BBI-44130568)</p> <p>Headpiece with 4 hose nozzles 4 x 1 mm (BBI-44130406)</p>
<p>Description:</p> <ul style="list-style-type: none"> • Clear glass with graduation 	



Alle / Verkaufsartikel / Accessories / Addition / Laboratory bottles

500 ml laboratory bottle with DIN thread, GL 45



bbi Scancode	BBI-44130562
External Thread	GL 45
HS-Code	70172000
Material	borosilicate glass

Components	1x laboratory bottle
Related Products	500 ml laboratory bottle GL 45 with gasket and screw cap with hole (BBI-44130576) Reservoir bottle 500 ml with 2 hose nozzles 4 x 1 mm (BBI-44130501) Reservoir bottle 500 ml with 4 hose nozzles 4 x 1 mm (BBI-44130504)
Description: <ul style="list-style-type: none"> • Clear glass with graduation 	



To the Shop:



Alle / Verkaufsartikel / Accessories / Addition / Laboratory bottles

1 L laboratory bottle with DIN thread, GL 45



bbi Scancode	BBI-44130563
External Thread	GL 45
HS-Code	70172000
Weight	0,58 kg
Material	borosilicate glass

Components	1x laboratory bottle
Description: <ul style="list-style-type: none"> • Clear glass with graduation 	



To the Shop:



Alle / Verkaufsartikel / Accessories / Addition / Laboratory bottles

2 L laboratory bottle with DIN thread, GL 45



bbi Scancode	BBI-44130564
External Thread	GL 45
HS-Code	70172000
Material	borosilicate glass

Components	1x laboratory bottle
Related Products	<p>2 L laboratory bottle with DIN thread, GL 45, plastic coated (BBI-44130571)</p> <p>2 l laboratory bottle GL 45 with gasket and screw cap with hole (BBI-44130578)</p> <p>Headpiece 1-1-1-4 for 2 L media bottle GL 45 (1 x Pg 13,5, 1 x L sparger, 1 x harvest pipe fixed, 4 x hose nozzle) (BBI-44131015)</p>
Description:	<ul style="list-style-type: none"> • Clear glass with graduation



Alle / Verkaufsartikel / Accessories / Addition / Laboratory bottles

5 L laboratory bottle with DIN thread, GL 45



bbi Scancode	BBI-44130565
External Thread	GL 45
Country of Origin	CZ 
HS-Code	70172000
Weight	1.89 kg
Material	borosilicate glass

Components	1x laboratory bottle
Related Products	<p>5 L laboratory bottle with DIN thread, GL 45, plastic coated (BBI-44130572)</p> <p>5 L wide-neck bottle GLS 80 GLS 80 with seal and screw cap with hole (BBI-44130591)</p> <p>5 l laboratory bottle GL 45 with gasket and screw cap with hole (BBI-44130579)</p>
Description:	<ul style="list-style-type: none"> • Clear glass with graduation



Alle / Verkaufsartikel / Accessories / Addition / Laboratory bottles

10 L laboratory bottle with DIN thread, GL 45



bbi Scancode	BBI-44130566
External Thread	GL 45
Country of Origin	CZ 
HS-Code	70172000
Material	borosilicate glass

Components	1x laboratory bottle
Related Products	<p>10 L wide-neck bottle GLS 80 (BBI-44130586)</p> <p>Screw cap GL 45 with hole, green (package of 10 pieces) (BBI-44130470)</p> <p>Seal for screw cap GL 45 (package of 10 pieces) (BBI-44130451)</p>
<p>Description:</p> <ul style="list-style-type: none"> • Clear glass with graduation 	



Alle / Verkaufsartikel / Accessories / Addition / Laboratory bottles

100 ml laboratory bottle with DIN thread, GL 45, plastic coated



bbi Scancode	BBI-44130567
External Thread	GL 45
Country of Origin	DE 
HS-Code	70172000
Material	borosilicate glass

Components	1x laboratory bottle
Related Products	<p>100 ml laboratory bottle GL 45 with gasket and screw cap with hole (BBI-44130574)</p> <p>100 ml laboratory bottle with DIN thread, GL 45 (BBI-44130560)</p> <p>Headpiece with 2 hose nozzles 4 x 1 mm (BBI-44130400)</p>
<p>Description:</p> <ul style="list-style-type: none"> • Clear glass with graduation • plastic coated • shatterproof 	



Alle / Verkaufsartikel / Accessories / Addition / Laboratory bottles

250 ml laboratory bottle with DIN thread, GL 45, plastic coated



bbi Scancode	BBI-44130568
External Thread	GL 45
Country of Origin	DE 
HS-Code	70172000
Material	borosilicate glass

Components	1x laboratory bottle
Related Products	<p>250 ml laboratory bottle GL 45 with gasket and screw cap with hole (BBI-44130575)</p> <p>250 ml laboratory bottle with DIN thread, GL 45 (BBI-44130561)</p> <p>Headpiece with 3 hose nozzles 6 x 1 mm (BBI-44130402)</p>
<p>Description:</p> <ul style="list-style-type: none"> • Clear glass with graduation • plastic coated • shatterproof 	



Alle / Verkaufsartikel / Accessories / Addition / Laboratory bottles

500 ml laboratory bottle with DIN thread, GL 45, plastic coated



bbi Scancode	BBI-44130569
External Thread	GL 45
Country of Origin	DE 
HS-Code	70172000
Material	borosilicate glass

Components	1x laboratory bottle
Related Products	<p>500 ml laboratory bottle GL 45 with gasket and screw cap with hole (BBI-44130576)</p> <p>500 ml laboratory bottle with DIN thread, GL 45 (BBI-44130562)</p> <p>Reservoir bottle 500 ml with 2 hose nozzles 4 x 1 mm (BBI-44130501)</p>
<p>Description:</p> <ul style="list-style-type: none"> • Clear glass with graduation • plastic coated • shatterproof 	



Alle / Verkaufsartikel / Accessories / Addition / Laboratory bottles

1 L laboratory bottle with DIN thread, GL 45, plastic coated



bbi Scancode	BBI-44130570
External Thread	GL 45
Country of Origin	DE 
HS-Code	70172000
Material	borosilicate glass

Components	1x laboratory bottle
<p>Description:</p> <ul style="list-style-type: none"> • Clear glass with graduation • plastic coated • shatterproof 	



Alle / Verkaufsartikel / Accessories / Addition / Laboratory bottles

2 L laboratory bottle with DIN thread, GL 45, plastic coated



bbi Scancode	BBI-44130571
External Thread	GL 45
Country of Origin	DE 
HS-Code	70172000
Material	borosilicate glass

Components	1x laboratory bottle
Related Products	<p>2 L laboratory bottle with DIN thread, GL 45 (BBI-44130564)</p> <p>2 l laboratory bottle GL 45 with gasket and screw cap with hole (BBI-44130578)</p> <p>Headpiece with 2 hose nozzles 4 x 1 mm (BBI-44130400)</p>
<p>Description:</p> <ul style="list-style-type: none"> • Clear glass with graduation • plastic coated • shatterproof 	



Alle / Verkaufsartikel / Accessories / Addition / Laboratory bottles

5 L laboratory bottle with DIN thread, GL 45, plastic coated



bbi Scancode	BBI-44130572
External Thread	GL 45
Country of Origin	DE 
HS-Code	70172000
Material	borosilicate glass

Components	1x laboratory bottle
Related Products	5 L laboratory bottle with DIN thread, GL 45 (BBI-44130565) 5 L wide-neck bottle GLS 80 (BBI-44130585) 5 l laboratory bottle GL 45 with gasket and screw cap with hole (BBI-44130579)
Description: <ul style="list-style-type: none"> • Clear glass with graduation • plastic coated • shatterproof 	



To the Shop:



Alle / Verkaufsartikel / Accessories / Addition / Laboratory bottles

10 L laboratory bottle with DIN thread, GL 45, plastic coated



bbi Scancode	BBI-44130573
External Thread	GL 45
Country of Origin	DE 
HS-Code	70172000
Material	borosilicate glass

Components	1x laboratory bottle
Related Products	<p>10 L laboratory bottle with DIN thread, GL 45 (BBI-44130566)</p> <p>10 L wide-neck bottle GLS 80 (BBI-44130586)</p> <p>Screw cap GL 45 with hole, red (package of 10 pieces) (BBI-44130450)</p>
<p>Description:</p> <ul style="list-style-type: none"> • Clear glass with graduation • plastic coated • shatterproof 	



Alle / Verkaufsartikel / Accessories / Addition / Laboratory bottles

100 ml laboratory bottle GL 45 with gasket and screw cap with hole



bbi Scancode	BBI-44130574
Manufacturer	bbi-biotech GmbH
Internal Thread	GL 45
External Thread	GL 45
Material Certificate	FDA
Country of Origin	DE 
HS-Code	70172000
Material	borosilicate glass PBT silicone transparent

Components	1x laboratory bottle [BBI-44130560]; 1x seal for screw cap [BBI-44130451]; 1x screw cap with hole [BBI-44130470]
Related Products	100 ml laboratory bottle with DIN thread, GL 45 (BBI-44130560) 100 ml laboratory bottle with DIN thread, GL 45, plastic coated (BBI-44130567) Headpiece with 2 hose nozzles 4 x 1 mm (BBI-44130400)
Description: <ul style="list-style-type: none"> • Clear glass with graduation • In a complete package with matching sealing ring and screw cap with hole 	



To the Shop:



Alle / Verkaufsartikel / Accessories / Addition / Laboratory bottles

250 ml laboratory bottle GL 45 with gasket and screw cap with hole



bbi Scancode	BBI-44130575
Manufacturer	bbi-biotech GmbH
Internal Thread	GL 45
External Thread	GL 45
Material Certificate	FDA
Country of Origin	DE 
HS-Code	70172000
Material	borosilicate glass PBT silicone transparent

Components	1x laboratory bottle [BBI-44130561]; 1x seal for screw cap [BBI-44130451]; 1x screw cap with hole [BBI-44130470]
Related Products	250 ml laboratory bottle with DIN thread, GL 45 (BBI-44130561) 250 ml laboratory bottle with DIN thread, GL 45, plastic coated (BBI-44130568) Headpiece with 2 hose nozzles 4 x 1 mm (BBI-44130400)
Description: <ul style="list-style-type: none"> • Clear glass with graduation • In a complete package with matching sealing ring and screw cap with hole 	



To the Shop:



Alle / Verkaufsartikel / Accessories / Addition / Laboratory bottles

500 ml laboratory bottle GL 45 with gasket and screw cap with hole



bbi Scancode	BBI-44130576
Manufacturer	bbi-biotech GmbH
Internal Thread	GL 45
External Thread	GL 45
Material Certificate	FDA
Country of Origin	DE 
HS-Code	70172000
Material	borosilicate glass PBT silicone transparent

Components	1x laboratory bottle [BBI-44130562]; 1x seal for screw cap [BBI-44130451]; 1x screw cap with hole [BBI-44130470]
Related Products	500 ml laboratory bottle with DIN thread, GL 45 (BBI-44130562) 500 ml laboratory bottle with DIN thread, GL 45, plastic coated (BBI-44130569) Headpiece with 2 hose nozzles 4 x 1 mm (BBI-44130400)
Description: <ul style="list-style-type: none"> • Clear glass with graduation • In a complete package with matching sealing ring and screw cap with hole 	



Alle / Verkaufsartikel / Accessories / Addition / Laboratory bottles

1 l laboratory bottle GL 45 with gasket and screw cap with hole



bbi Scancode	BBI-44130577
Manufacturer	bbi-biotech GmbH
Internal Thread	GL 45
External Thread	GL 45
Material Certificate	FDA
HS-Code	70172000
Material	borosilicate glass PBT silicone transparent

Components	1x laboratory bottle [BBI-44130563]; 1x seal for screw cap [BBI-44130451]; 1x screw cap with hole [BBI-44130470]
Description:	<ul style="list-style-type: none"> • Clear glass with graduation • In a complete package with matching sealing ring and screw cap with hole



Alle / Verkaufsartikel / Accessories / Addition / Laboratory bottles

2 l laboratory bottle GL 45 with gasket and screw cap with hole



bbi Scancode	BBI-44130578
Manufacturer	bbi-biotech GmbH
Internal Thread	GL 45
External Thread	GL 45
Material Certificate	FDA
HS-Code	70172000
Material	borosilicate glass PBT silicone transparent

Components	1x laboratory bottle [BBI-44130564]; 1x seal for screw cap [BBI-44130451]; 1x screw cap with hole [BBI-44130470]
Related Products	2 L laboratory bottle with DIN thread, GL 45, plastic coated (BBI-44130571) Headpiece with 2 hose nozzles 6 x 1 mm (BBI-44130414) Headpiece with 4 hose nozzles 4 x 1 mm and 1 x Inoculation port with septum (BBI-44130445)
Description: <ul style="list-style-type: none"> • Clear glass with graduation • In a complete package with matching sealing ring and screw cap with hole 	



To the Shop:



Alle / Verkaufsartikel / Accessories / Addition / Laboratory bottles

5 l laboratory bottle GL 45 with gasket and screw cap with hole



bbi Scancode	BBI-44130579
Manufacturer	bbi-biotech GmbH
Internal Thread	GL 45
External Thread	GL 45
Material Certificate	FDA
Country of Origin	DE 
HS-Code	70172000
Material	borosilicate glass PBT silicone transparent

Components	1x laboratory bottle [BBI-44130565]; 1x seal for screw cap [BBI-44130451]; 1x screw cap with hole [BBI-44130470]
Related Products	5 L laboratory bottle with DIN thread, GL 45 (BBI-44130565) 5 L laboratory bottle with DIN thread, GL 45, plastic coated (BBI-44130572) 5 L wide-neck bottle GLS 80 (BBI-44130585)
Description: <ul style="list-style-type: none"> • Clear glass with graduation • In a complete package with matching sealing ring and screw cap with hole 	



Alle / Verkaufsartikel / Accessories / Addition / Laboratory bottles

10 l laboratory bottle GL 45 with gasket and screw cap with hole



bbi Scancode	BBI-44130580
Manufacturer	bbi-biotech GmbH
Internal Thread	GL 45
External Thread	GL 45
Material Certificate	FDA
HS-Code	70172000
Material	borosilicate glass PBT silicone transparent

Components	1x laboratory bottle [BBI-44130566]; 1x seal for screw cap [BBI-44130451]; 1x screw cap with hole [BBI-44130470]
Related Products	10 L wide-neck bottle GLS 80 GLS 80 with seal and screw cap with hole (BBI-44130592) Headpiece with 2 hose nozzles 4 x 1 mm and 1 x Inoculation port with septum (BBI-44130443) Headpiece with 2 hose nozzles 6 x 1 mm (BBI-44130414)
<p>Description:</p> <ul style="list-style-type: none"> • Clear glass with graduation • In a complete package with matching sealing ring and screw cap with hole 	



Alle / Verkaufsartikel / Accessories / Addition / Laboratory bottles

250 ml wide-neck bottle GLS 80



bbi Scancode	BBI-44130581
Manufacturer	bbi-biotech GmbH
External Thread	GLS 80
Material Certificate	FDA
Country of Origin	DE 
Material	borosilicate glass

Components	1x laboratory bottle
Related Products	250 ml laboratory bottle with DIN thread, GL 45 (BBI-44130561) 250 ml wide-neck bottle GLS 80 GLS 80 with seal and screw cap with hole (BBI-44130587) Screw cap GLS 80 with hole, blue (BBI-44130464)
<p>Description:</p> <ul style="list-style-type: none"> • Clear glass with graduation • 80 mm wide bottle neck outer diameter 	



Alle / Verkaufsartikel / Accessories / Addition / Laboratory bottles

500 ml wide-neck bottle GLS 80



bbi Scancode	BBI-44130582
External Thread	GLS 80
Material	borosilicate glass

Components	1x laboratory bottle
Related Products	500 ml laboratory bottle GL 45 with gasket and screw cap with hole (BBI-44130576) 500 ml wide-neck bottle GLS 80 GLS 80 with seal and screw cap with hole (BBI-44130588) Kopfstück für 0,5 L Vorratsflasche GLS 80 (3 x Pg 13,5, 1 x Inokulationsport, 1 x L-Sparger, 1 x Harvest pipe fixed, 1 x Pt100 sleeve, 4 x hose nozzle) (BBI-44130465)
Description: <ul style="list-style-type: none"> • Clear glass with graduation • 80 mm wide bottle neck outer diameter 	



To the Shop:



Alle / Verkaufsartikel / Accessories / Addition / Laboratory bottles

1 L wide-neck bottle GLS 80



bbi Scancode	BBI-44130583
External Thread	GLS 80
Material	borosilicate glass

Components	1x laboratory bottle
Description: <ul style="list-style-type: none"> • Clear glass with graduation • 80 mm wide bottle neck outer diameter 	



To the Shop:



Alle / Verkaufsartikel / Accessories / Addition / Laboratory bottles

2 L wide-neck bottle GLS 80



bbi Scancode	BBI-44130584
External Thread	GLS 80
Material	borosilicate glass

Components	1x laboratory bottle
Related Products	2 L laboratory bottle with DIN thread, GL 45 (BBI-44130564) 2 L wide-neck bottle GLS 80 GLS 80 with seal and screw cap with hole (BBI-44130590) Headpiece 3-1-3-4 with 2 L reservoir bottle GLS 80 (BBI-44130433)
Description: <ul style="list-style-type: none"> • Clear glass with graduation • 80 mm wide bottle neck outer diameter 	



To the Shop:



Alle / Verkaufsartikel / Accessories / Addition / Laboratory bottles

5 L wide-neck bottle GLS 80



bbi Scancode	BBI-44130585
External Thread	GLS 80
Material	borosilicate glass

Components	1x laboratory bottle
Related Products	5 L laboratory bottle with DIN thread, GL 45 (BBI-44130565) 5 L wide-neck bottle GLS 80 GLS 80 with seal and screw cap with hole (BBI-44130591) Headpiece 3-1-3-4 with 5 L reservoir bottle GLS 80 (BBI-44130434)
Description: <ul style="list-style-type: none"> • Clear glass with graduation • 80 mm wide bottle neck outer diameter 	



To the Shop:



Alle / Verkaufsartikel / Accessories / Addition / Laboratory bottles

10 L wide-neck bottle GLS 80



bbi Scancode	BBI-44130586
External Thread	GLS 80
Material	borosilicate glass

Components	1x laboratory bottle
Related Products	10 L laboratory bottle with DIN thread, GL 45 (BBI-44130566) 10 L wide-neck bottle GLS 80 GLS 80 with seal and screw cap with hole (BBI-44130592) Seal for screw cap GLS 80 (package of 5 pieces) (BBI-44130463)
Description: <ul style="list-style-type: none"> • Clear glass with graduation • 80 mm wide bottle neck outer diameter 	



To the Shop:



Alle / Verkaufsartikel / Accessories / Addition / Laboratory bottles

250 ml wide-neck bottle GLS 80 GLS 80 with seal and screw cap with hole



bbi Scancode	BBI-44130587
Manufacturer	bbi-biotech GmbH
Internal Thread	GLS 80
External Thread	GLS 80
Material Certificate	FDA
Material	borosilicate glass PBT silicone transparent

Components	1x laboratory bottle [BBI-44130581]; 1x seal for screw cap [BBI-44130463]; 1x screw cap with hole [BBI-44130464]
Related Products	250 ml laboratory bottle with DIN thread, GL 45 (BBI-44130561) 250 ml wide-neck bottle GLS 80 (BBI-44130581) Screw cap GLS 80 with hole, blue (BBI-44130464)
Description: <ul style="list-style-type: none"> • Clear glass with graduation • 80 mm wide bottle neck outer diameter • In a complete package with matching sealing ring and screw cap with hole 	



To the Shop:



Alle / Verkaufsartikel / Accessories / Addition / Laboratory bottles

500 ml wide-neck bottle GLS 80 GLS 80 with seal and screw cap with hole



bbi Scancode	BBI-44130588
Manufacturer	bbi-biotech GmbH
Internal Thread	GLS 80
External Thread	GLS 80
Material Certificate	FDA
Country of Origin	DE 
Material	borosilicate glass PBT silicone transparent

Components	1x laboratory bottle [BBI-44130582]; 1x seal for screw cap [BBI-44130463]; 1x screw cap with hole [BBI-44130464]
Related Products	500 ml laboratory bottle GL 45 with gasket and screw cap with hole (BBI-44130576) 500 ml wide-neck bottle GLS 80 GLS 80 with seal and screw cap with hole (BBI-44130588) Kopfstück für 0,5 L Vorratsflasche GLS 80 (3 x Pg 13,5, 1 x Inokulationsport, 1 x L-Sparger, 1 x Harvest pipe fixed, 1 x Pt100 sleeve, 4 x hose nozzle) (BBI-44130465)
Description: <ul style="list-style-type: none"> • Clear glass with graduation • 80 mm wide bottle neck outer diameter • In a complete package with matching sealing ring and screw cap with hole 	



To the Shop:



Alle / Verkaufsartikel / Accessories / Addition / Laboratory bottles

1 L wide-neck bottle GLS 80 GLS 80 with seal and screw cap with hole



bbi Scancode	BBI-44130589
Manufacturer	bbi-biotech GmbH
Internal Thread	GLS 80
External Thread	GLS 80
Material Certificate	FDA
Material	borosilicate glass PBT silicone transparent

Components

1x laboratory bottle [BBI-44130583]; 1x seal for screw cap [BBI-44130463]; 1x screw cap with hole [BBI-44130464]

Description:

- Clear glass with graduation
- 80 mm wide bottle neck outer diameter
- In a complete package with matching sealing ring and screw cap with hole



To the Shop:



Alle / Verkaufsartikel / Accessories / Addition / Laboratory bottles

2 L wide-neck bottle GLS 80 GLS 80 with seal and screw cap with hole



bbi Scancode	BBI-44130590
Manufacturer	bbi-biotech GmbH
Internal Thread	GLS 80
External Thread	GLS 80
Material Certificate	FDA
Material	borosilicate glass PBT silicone transparent

Components	1x laboratory bottle [BBI-44130584]; 1x seal for screw cap [BBI-44130463]; 1x screw cap with hole [BBI-44130464]
Related Products	2 L wide-neck bottle GLS 80 (BBI-44130584) 2 l laboratory bottle GL 45 with gasket and screw cap with hole (BBI-44130578) Headpiece 3-1-3-4 with 2 L reservoir bottle GLS 80 (BBI-44130433)
Description: <ul style="list-style-type: none"> • Clear glass with graduation • 80 mm wide bottle neck outer diameter • In a complete package with matching sealing ring and screw cap with hole 	



To the Shop:



Alle / Verkaufsartikel / Accessories / Addition / Laboratory bottles

5 L wide-neck bottle GLS 80 GLS 80 with seal and screw cap with hole



bbi Scancode	BBI-44130591
Manufacturer	bbi-biotech GmbH
Internal Thread	GLS 80
External Thread	GLS 80
Material Certificate	FDA
Material	borosilicate glass PBT silicone transparent

Components	1x laboratory bottle [BBI-44130585]; 1x seal for screw cap [BBI-44130463]; 1x screw cap with hole [BBI-44130464]
Related Products	5 L laboratory bottle with DIN thread, GL 45 (BBI-44130565) 5 L wide-neck bottle GLS 80 (BBI-44130585) Headpiece 3-1-3-4 with 5 L reservoir bottle GLS 80 (BBI-44130434)
<p>Description:</p> <ul style="list-style-type: none"> • Clear glass with graduation • 80 mm wide bottle neck outer diameter • In a complete package with matching sealing ring and screw cap with hole 	



Alle / Verkaufsartikel / Accessories / Addition / Laboratory bottles

10 L wide-neck bottle GLS 80 GLS 80 with seal and screw cap with hole



bbi Scancode	BBI-44130592
Manufacturer	bbi-biotech GmbH
Internal Thread	GLS 80
External Thread	GLS 80
Material Certificate	FDA
Country of Origin	DE 
Material	borosilicate glass PBT silicone transparent

Components	1x laboratory bottle [BBI-44130586]; 1x seal for screw cap [BBI-44130463]; 1x screw cap with hole [BBI-44130464]
Related Products	10 L laboratory bottle with DIN thread, GL 45 (BBI-44130566) 10 L wide-neck bottle GLS 80 (BBI-44130586) Seal for screw cap GLS 80 (package of 5 pieces) (BBI-44130463)
<p>Description:</p> <ul style="list-style-type: none"> • Clear glass with graduation • 80 mm wide bottle neck outer diameter • In a complete package with matching sealing ring and screw cap with hole 	



Alle / Verkaufsartikel / Accessories / Addition / Membrane holders

Membrane Holder Rd 28 x 1/8



bbi Scancode	BBI-44130005
Manufacturer	bbi-biotech GmbH
Internal Thread	Rd 28 x 1/8
External Thread	Rd 28 x 1/8
Material Certificate	3.1, Rauigkeit
Country of Origin	DE 
HS-Code	73269098
Weight	0.1 kg
Material	Stainless steel 316L

Components	1x membrane holder
Related Products	Membrane 19 mm (Package of 20 pieces) (BBI-44130021) Membrane holder 25 mm for G 1 1/4" (Ingold socket) with Rd 28 x 1/8 inner thread (BBI-44130117) Membrane holder M 26 x 1 (BBI-44130018)
Description: <ul style="list-style-type: none"> • For use with membranes in bioreactor headplates • For use with addition ports and inoculation needles • Common for autoclavable systems • With inner thread for closing with blind plugs or use with screwable inoculation kits • Membranes [BBI-44130004] or [BBI-44130021] are available separately 	



To the Shop:



Alle / Verkaufsartikel / Accessories / Addition / Membrane holders

Membrane holder M 26 x 1



bbi Scancode	BBI-44130018
Manufacturer	bbi-biotech GmbH
Internal Thread	M 26 x 1
External Thread	M 26 x 1
Material Certificate	3.1, Rauigkeit
Country of Origin	DE 
HS-Code	73269098
Weight	0.1 kg
Material	Stainless steel 316L

Components	1x membrane holder
Related Products	<p>Membrane 19 mm (Package of 20 pieces) (BBI-44130021)</p> <p>Membrane Holder Rd 28 x 1/8 (BBI-44130005)</p> <p>Membrane holder 25 mm for G 1 1/4" (Ingold socket) with Rd 28 x 1/8 inner thread (BBI-44130117)</p>
<p>Description:</p> <ul style="list-style-type: none"> • For use with membranes in bioreactor headplates • For use with addition ports and inoculation needles • Common for autoclavable systems • With inner thread for closing with blind plugs or use with screwable inoculation kits • Membranes [BBI-44130004] or [BBI-44130021] are available separately 	



Alle / Verkaufsartikel / Accessories / Addition / Membrane holders

Membrane holder 25 mm for G 1 1/4" (Ingold socket) with Rd 28 x 1/8 inner thread



bbi Scancode	BBI-44130117
Manufacturer	bbi-biotech GmbH
Internal Thread	G 1 1/4
Material Certificate	3.1, Rauigkeit, FDA
Country of Origin	DE 
HS-Code	73269098
Weight	0.33 kg
Material	Stainless steel 316L EPDM black Brombutyl

Components	1x membrane holder, 1x coupling nut with circlip [BBI-44130011], 1x membrane [BBI-44130004], 1x O-ring [BBI-45100014]
Related Products	Membrane 19mm (Package of 20 pieces) (BBI-44130004) Membrane Holder Rd 28 x 1/8 (BBI-44130005) Membrane holder M 26 x 1 (BBI-44130018)

Description:

- For use with membranes in bioreactor headplates
- For use with addition ports and inoculation needles
- Common for in-situ systems for 25 mm standard Ingold port
- With inner thread for closing with blind plugs or use with screwable inoculation kits
- Membranes [BBI-44130004] or [BBI-44130021] are available separately



To the Shop:



Alle / Verkaufsartikel / Accessories / Addition / STT couplings

STT quick connect coupling (3.2 - 5.0 mm, half, female)



bbi Scancode	BBI-44130650
Manufacturer	bbi-biotech GmbH
Material Certificate	FDA
Country of Origin	DE 
HS-Code	73269098
Weight	0.04 kg
Material	Stainless steel 316L NK 417 nature

Components	1x STT quick connect coupling (female half); 1x blind plug; 1x o-ring [BBI-45100011]; 1x slit membrane [BBI-44130654]
Consumables	Membrane for STT-couplings (package of 20 pieces) (BBI-44130654) O-ring for items to install in 11 mm ports (package of 10 pieces) (BBI-45100011)
Related Products	Membrane for STT-couplings (package of 20 pieces) (BBI-44130654) STT quick connect coupling (1.6 - 2.0 mm, half, female) (BBI-44130652) STT quick connect coupling (3.2 - 5.0 mm, half, male) (BBI-44130651)

Description:

- STT quick connect couplings are used for sterile tube connections between culture vessel and harvest or inoculation vessels. Easy, secure and fast handling! The female part of a STT quick coupling is normally used on the side of the culture vessel.
- Autoclavable quick connect coupling half made of stainless steel
- For sterile connections of tubes with an internal diameter of 3.2 ... 5.0 mm
- With membrane [BBI-44130654]
- Male coupling is available separately



Alle / Verkaufsartikel / Accessories / Addition / STT couplings

STT quick connect coupling (3.2 - 5.0 mm, half, male)



bbi Scancode	BBI-44130651
Manufacturer	bbi-biotech GmbH
Country of Origin	DE 
HS-Code	73269098
Weight	0.03 kg
Material	Stainless steel 316L

Components	1x STT quick connect coupling (male half); 1x cap; 1x o-ring [BBI-45100011]
Consumables	O-ring for items to install in 11 mm ports (package of 10 pieces) (BBI-45100011)
Related Products	Membrane for STT-couplings (package of 20 pieces) (BBI-44130654) STT quick connect coupling (1.6 - 2.0 mm, half, male) (BBI-44130653) STT quick connect coupling (3.2 - 5.0 mm, half, female) (BBI-44130650)

Description:

- STT quick connect couplings are used for sterile tube connections between culture vessel and harvest or inoculation vessels. Easy, secure and fast handling! The male part of a STT quick coupling is normally used on the side of the harvest/inoculation vessel.
- Autoclavable quick connect coupling half made of stainless steel
- For sterile connections of tubes with an internal diameter of 3.2 ... 5.0 mm
- Female coupling is available separately



Alle / Verkaufsartikel / Accessories / Addition / STT couplings

STT quick connect coupling (1.6 - 2.0 mm, half, female)



bbi Scancode	BBI-44130652
Manufacturer	bbi-biotech GmbH
Material Certificate	FDA
Country of Origin	DE 
HS-Code	73269098
Weight	0.04 kg
Material	Stainless steel 316L NK 417 nature

Components	1x STT quick connect coupling (female half); 1x blind plug; 1x o-ring [BBI-45100011]; 1x slit membrane [BBI-44130654]
Consumables	O-ring for items to install in 11 mm ports (package of 10 pieces) (BBI-45100011) Membrane for STT-couplings (package of 20 pieces) (BBI-44130654)
Related Products	Membrane for STT-couplings (package of 20 pieces) (BBI-44130654) STT quick connect coupling (1.6 - 2.0 mm, half, male) (BBI-44130653) STT quick connect coupling (3.2 - 5.0 mm, half, female) (BBI-44130650)

Description:

- STT quick connect couplings are used for sterile tube connections between culture vessel and harvest or inoculation vessels. Easy, secure and fast handling! The female part of a STT quick coupling is normally used on the side of the culture vessel.
- Autoclavable quick connect coupling half made of stainless steel
- For sterile connections of tubes with an internal diameter of 1.6... 2.0 mm
- With membrane [BBI-44130654]
- Male coupling is available separately



Alle / Verkaufsartikel / Accessories / Addition / STT couplings

STT quick connect coupling (1.6 - 2.0 mm, half, male)



bbi Scancode	BBI-44130653
Manufacturer	bbi-biotech GmbH
Country of Origin	DE 
HS-Code	73269098
Weight	0.03 kg
Material	Stainless steel 316L

Components	1x STT quick connect coupling, male half; 1x cap; 1x o-ring [BBI-45100011]
Consumables	O-ring for items to install in 11 mm ports (package of 10 pieces) (BBI-45100011)
Related Products	Membrane for STT-couplings (package of 20 pieces) (BBI-44130654) STT quick connect coupling (1.6 - 2.0 mm, half, female) (BBI-44130652) STT quick connect coupling (3.2 - 5.0 mm, half, male) (BBI-44130651)

Description:

- Autoclavable quick connect coupling half made of stainless steel
- STT quick connect couplings are used for sterile tube connections between culture vessel and harvest or inoculation vessels. Easy, secure and fast handling! The male part of a STT quick coupling is normally used on the side of the harvest/inoculation vessel.
- For sterile connections of tubes with an internal diameter of 1.6 ... 2.0 mm
- Female coupling is available separately



Alle / Verkaufsartikel / Accessories / Addition / Sacovas

1-way Sacova 4 mm for Rd 28 x 1/8 standard port



bbi Scancode	BBI-43630203
Manufacturer	bbi-biotech GmbH
External Thread	Rd 28 x 1/8
Material Certificate	3.1, Rauigkeit, FDA
Country of Origin	DE 
HS-Code	73269098
Weight	0.15 kg
Material	Stainless steel 316L EPDM black

Components	1x Sacova-valve; 1x o-ring [BBI-45100015]
Consumables	O-ring for items to install in M 26 x 1 ports (package of 10 pieces) (BBI-45100015)
Description: <ul style="list-style-type: none"> • Needle less addition valve/addition port • Installation in standard headplate port • For adding media and correction fluids • Adding without piercing a membrane or prior flaming • After autoclave or in-situ sterilization a valve can be opened to add media in an aseptic way • Hose nozzle Di = 4 mm • Accessories for bioreactors 	



To the Shop:



Alle / Verkaufsartikel / Accessories / Addition / Sacovas

1-way Sacova 4 mm for 19 mm Ingold-port



bbi Scancode	BBI-43630204
Manufacturer	bbi-biotech GmbH
Internal Thread	Rd 28 × 1/8
Material Certificate	3.1, Rauigkeit, FDA
Country of Origin	DE 
HS-Code	73269098
Weight	0.3 kg
Material	Stainless steel 316L EPDM black

Components	1x Sacova-valve; 1x o-ring
Description: <ul style="list-style-type: none"> • Needle less addition valve/addition port • Installation in side port of a bioreactor • For adding media and correction fluids • Adding without piercing a membrane or prior flaming • After autoclave or in-situ sterilization a valve can be opened to add media in an aseptic way • Hose nozzle Di = 4 mm • Accessories for bioreactors 	



To the Shop:



Alle / Verkaufsartikel / Accessories / Addition / Sacovas

3-way Sacova 4 mm for 25 mm Ingold-port



bbi Scancode	BBI-43630205
Manufacturer	bbi-biotech GmbH
Internal Thread	G 1 1/4
Material Certificate	3.1, Rauigkeit, FDA
Country of Origin	DE 
HS-Code	73269098
Material	Stainless steel 316L EPDM black

Components	1x Sacova-valve; 1x o-ring
Related Products	1-way Sacova 6 mm for 25 mm Ingold-port (BBI-43630212) 1-way Sacova 8 mm for 25 mm Ingold-port (BBI-43630211) 3-way Sacova 4 mm for 25 mm Ingold-port (BBI-43630205)

Description:

- Needle less addition valve/addition port
- Installation in side port of a bioreactor
- For adding media and correction fluids
- Adding without piercing a membrane or prior flaming
- After autoclave or in-situ sterilization a valve can be opened to add media in an aseptic way
- 3x hose nozzles Di = 2 mm
- Accessories for bioreactors



Alle / Verkaufsartikel / Accessories / Addition / Sacovas

3-way Sacova 4 mm for Rd 28 x 1/8 standard port



bbi Scancode	BBI-43630206
Manufacturer	bbi-biotech GmbH
External Thread	Rd 28 x 1/8
Material Certificate	3.1, Rauigkeit, FDA
Country of Origin	DE 
HS-Code	73269098
Weight	0.24 kg
Material	Stainless steel 316L EPDM black

Components	1x Sacova-valve; 1x o-ring [BBI-45100015]
Consumables	O-ring 14.00 x 1.78 mm (package of 5 pieces) (BBI-45100017)
Related Products	1-way Sacova 6 mm for Rd 28 x 1/8 standard port (BBI-43630207) 1-way Sacova 8 mm for Rd 28 x 1/8 standard port (BBI-43630209) 3-way Sacova 4 mm for Rd 28 x 1/8 standard port (BBI-43630206)

Description:

- Needle less addition valve / addition port
- Installation in standard headplate port of a bioreactor
- For adding media and correction fluids
- Adding without piercing a membrane and prior flaming
- After autoclave or in-situ sterilization a valve can be opened to add media in an aseptic way
- With 3 hose nozzles ID = 2 mm
- Accessories for bioreactors



Alle / Verkaufsartikel / Accessories / Addition / Sacovas

1-way Sacova 6 mm for Rd 28 x 1/8 standard port



bbi Scancode	BBI-43630207
Manufacturer	bbi-biotech GmbH
External Thread	Rd 28 x 1/8
Material Certificate	3.1, Rauigkeit, FDA
Country of Origin	DE 
HS-Code	73269098
Weight	0.07 kg
Material	Stainless steel 316L EPDM black

Components	1x Sacova-valve; 1x o-ring [BBI-45100015]
Consumables	O-ring for items to install in M 26 x 1 ports (package of 10 pieces) (BBI-45100015)

Description:

- Needle less addition valve/addition port
- Installation in side port of a bioreactor
- For adding media and correction fluids
- Adding without piercing a membrane or prior flaming
- After autoclave or in-situ sterilization a valve can be opened to add media in an aseptic way
- Hose nozzle Di = 6 mm
- Accessories for bioreactors



To the Shop:



Alle / Verkaufsartikel / Accessories / Addition / Sacovas

1-way Sacova 6 mm for 19 mm Ingold-port



bbi Scancode	BBI-43630208
Manufacturer	bbi-biotech GmbH
Internal Thread	Rd 28 x 1/8
Material Certificate	3.1, Rauigkeit, FDA
Country of Origin	DE 
HS-Code	73269098
Material	Stainless steel 316L EPDM black

Components	1x Sacova-valve; 1x o-ring
<p>Description:</p> <ul style="list-style-type: none"> • Needle less addition valve/addition port • Installation in side port of a bioreactor • For adding media and correction fluids • Adding without piercing a membrane or prior flaming • After autoclave or in-situ sterilization a valve can be opened to add media in an aseptic way • Hose nozzle Di = 6 mm • Accessories for bioreactors 	



Alle / Verkaufsartikel / Accessories / Addition / Sacovas

1-way Sacova 8 mm for Rd 28 x 1/8 standard port



bbi Scancode	BBI-43630209
Manufacturer	bbi-biotech GmbH
External Thread	Rd 28 x 1/8
Material Certificate	3.1, Rauigkeit, FDA
Country of Origin	DE 
HS-Code	73269098
Weight	0.23 kg
Material	Stainless steel 316L EPDM black

Components	1x Sacova-valve; 1x o-ring [BBI-45100015]
<p>Description:</p> <ul style="list-style-type: none"> • Needle less addition valve/addition port • Installation in standard headplate port • For adding media and correction fluids • Adding without piercing a membrane or prior flaming • After autoclave or in-situ sterilization a valve can be opened to add media in an aseptic way • Hose nozzle Di = 8 mm • Accessories for bioreactors 	



Alle / Verkaufsartikel / Accessories / Addition / Sacovas

1-way Sacova 8 mm for 19 mm Ingold-port



bbi Scancode	BBI-43630210
Manufacturer	bbi-biotech GmbH
Internal Thread	Rd 28 x 1/8
Material Certificate	3.1, Rauigkeit, FDA
Country of Origin	DE 
HS-Code	73269098
Material	Stainless steel 316L EPDM black

Components	1x Sacova-valve; 1x o-ring
<p>Description:</p> <ul style="list-style-type: none"> • Needle less addition valve/addition port • Installation in standard headplate port • For adding media and correction fluids • Adding without piercing a membrane or prior flaming • After autoclave or in-situ sterilization a valve can be opened to add media in an aseptic way • Hose nozzle Di = 8 mm • Accessories for bioreactors 	



Alle / Verkaufsartikel / Accessories / Addition / Sacovas

1-way Sacova 8 mm for 25 mm Ingold-port



bbi Scancode	BBI-43630211
Manufacturer	bbi-biotech GmbH
Internal Thread	G 1 1/4
Material Certificate	3.1, Rauigkeit, FDA
Country of Origin	DE 
HS-Code	73269098
Material	Stainless steel 316L EPDM black

Components	1x Sacova-valve; 1x o-ring
-------------------	----------------------------

Description:

- Needle less addition valve/addition port
- Installation in standard headplate port
- For adding media and correction fluids
- Adding without piercing a membrane or prior flaming
- After autoclave or in-situ sterilization a valve can be opened to add media in an aseptic way
- Hose nozzle Di = 8 mm
- Accessories for bioreactors



Alle / Verkaufsartikel / Accessories / Addition / Sacovas

1-way Sacova 6 mm for 25 mm Ingold-port



bbi Scancode	BBI-43630212
Manufacturer	bbi-biotech GmbH
Internal Thread	G 1 1/4
Material Certificate	3.1, Rauigkeit, FDA
Country of Origin	DE 
HS-Code	73269098
Material	Stainless steel 316L EPDM black

Components	1x Sacova-valve; 1x o-ring
<p>Description:</p> <ul style="list-style-type: none"> • Needle less addition valve/addition port • Installation in side port of a bioreactor • For adding media and correction fluids • Adding without piercing a membrane or prior flaming • After autoclave or in-situ sterilization a valve can be opened to add media in an aseptic way • Hose nozzle Di = 6 mm • Accessories for bioreactors 	



Alle / Verkaufsartikel / Accessories / Addition / Sacovas

1-way Sacova 4 mm for 25 mm Ingold-port



bbi Scancode	BBI-43630213
Manufacturer	bbi-biotech GmbH
Internal Thread	G 1 1/4
Material Certificate	3.1, Rauigkeit, FDA
Country of Origin	DE 
HS-Code	73269098
Material	Stainless steel 316L EPDM black

Components	1x Sacova-valve; 1x o-ring
<p>Description:</p> <ul style="list-style-type: none"> • Needle less addition valve/addition port • Installation in standard headplate port • For adding media and correction fluids • Adding without piercing a membrane or prior flaming • After autoclave or in-situ sterilization a valve can be opened to add media in an aseptic way • Hose nozzle Di = 4 mm • Accessories for bioreactors 	



Alle / Verkaufsartikel / Accessories / Addition / Sacovas

1-way Sacova 8 mm for 30 mm-Port



bbi Scancode	BBI-43630214
Manufacturer	bbi-biotech GmbH
Internal Thread	G 1 1/4
Material Certificate	3.1, Rauigkeit, FDA
Country of Origin	DE 
HS-Code	73269098
Material	Stainless steel 316L EPDM black

Components

1x Sacova-valve; 1x o-ring

Description:

- Needle less addition valve/addition port
- Installation in standard headplate port
- For adding media and correction fluids
- Adding without piercing a membrane or prior flaming
- After autoclave or in-situ sterilization a valve can be opened to add media in an aseptic way
- Hose nozzle Di = 8 mm
- Accessories for bioreactors



To the Shop:



Alle / Verkaufsartikel / Accessories / Addition / Screw caps

Screw cap GL 45 with hole, red (package of 10 pieces)



bbi Scancode	BBI-44130450
Internal Thread	GL 45
Country of Origin	DE 
HS-Code	39235010
Weight	0.2 kg
Material	PBT

Components	10x screw cap
Related Products	Screw cap GL 45 with hole (set: red, yellow, green, blue) (BBI-44130473) Screw cap GL 45 with hole, green (package of 10 pieces) (BBI-44130470) Screw cap GL 45 with hole, yellow (package of 10 pieces) (BBI-44130472)
Description: <ul style="list-style-type: none"> • Screw cap GL 45 with central hole \varnothing 34 mm • Red • For corrective media bottles • For use with headpieces and seals (available separately) • Usable up to 180°C • Package: 10 pieces 	



To the Shop:



Alle / Verkaufsartikel / Accessories / Addition / Screw caps

Screw cap GL 18 with hole (package of 10 pieces)



bbi Scancode	BBI-44130452
Internal Thread	GL 18
Country of Origin	NU
HS-Code	39235010
Material	PBT

Components	10x screw cap
Related Products	Hose connection set vessel GL 18 (BBI-44430111) Screw cap GL 18 with hose nozzle (BBI-44130459) Seal for screw cap GL 18 (package of 10 pieces) (BBI-44130453)
<p>Description:</p> <ul style="list-style-type: none"> • Screw cap GL 18 with central hole Ø 11 mm • Red • Usable up to 180°C • Package: 10 pieces 	



Alle / Verkaufsartikel / Accessories / Addition / Screw caps

Screw cap GL 25 with hole (package of 10 pieces)



bbi Scancode	BBI-44130454
Internal Thread	GL 25
Country of Origin	DE 
HS-Code	39235010
Weight	0.09 kg
Material	PBT

Components	10x screw cap
Related Products	Screw cap GL 14 with hole (package of 10 pieces) (BBI-44130457) Screw cap GL 25 with hole (for manual sampler) (BBI-44130456) Seal for screw cap GL 25 (package of 10 pieces) (BBI-44130455)
Description: <ul style="list-style-type: none"> • Screw cap GL 25 with central hole \varnothing 15 mm • Red • Usable up to 180°C • Package: 10 pieces 	



To the Shop:



Alle / Verkaufsartikel / Accessories / Addition / Screw caps

Screw cap GL 25 with hole (for manual sampler)



bbi Scancode	BBI-44130456
Internal Thread	GL 25
Country of Origin	DE 
HS-Code	39235010
Weight	0.01 kg
Material	PBT

Components	1x screw cap
Related Products	Screw cap GL 25 with hole (package of 10 pieces) (BBI-44130454) Screw cap GL 32 with hole (package of 10 pieces) (BBI-44130461) Seal for screw cap GL 25 (package of 10 pieces) (BBI-44130455)
Description: <ul style="list-style-type: none"> • Screw cap GL 25 with central hole \varnothing 18 mm • Red • Usable up to 180°C • Package: 10 pieces 	



To the Shop:



Alle / Verkaufsartikel / Accessories / Addition / Screw caps

Screw cap GL 14 with hole (package of 10 pieces)



bbi Scancode	BBI-44130457
Internal Thread	GL 14
Country of Origin	DE 
HS-Code	39235010
Material	PBT

Components	10x screw cap
Related Products	Hose connection set vessel GL 14 (BBI-44430110) Olive, curved, GL 14 (BBI-44430100) Screw cap GL 14 with hose nozzle (BBI-44130458)
<p>Description:</p> <ul style="list-style-type: none"> • Screw cap GL 14 with central hole \varnothing 9,5 mm • Red • For jacketed glass vessels • For use with hose nozzle for GL 14 (available separately) • Usable up to 180°C 	



Alle / Verkaufsartikel / Accessories / Addition / Screw caps

Screw cap GL 14 with hose nozzle



bbi Scancode	BBI-44130458
Internal Thread	GL 14
Country of Origin	DE 
HS-Code	39174000
Material	PBT PP

Components	1x screw cap; 1x hose nozzle
Consumables	Olive, curved, GL 14 (BBI-44430100) Screw cap GL 14 with hole (package of 10 pieces) (BBI-44130457)
Related Products	Hose connection set vessel GL 14 (BBI-44430110) Olive, curved, GL 14 (BBI-44430100) Screw cap GL 14 with hole (package of 10 pieces) (BBI-44130457)
<p>Description:</p> <ul style="list-style-type: none"> • Screw cap GL 14 with central hole and hose nozzle • Red • For jacketed glass vessels • Hose nozzle GL 14 also available separately • Usable up to 180°C 	



Alle / Verkaufsartikel / Accessories / Addition / Screw caps

Screw cap GL 18 with hose nozzle



bbi Scancode	BBI-44130459
Internal Thread	GL 18
Country of Origin	DE 
HS-Code	39174000
Material	PBT PP

Components	1x screw cap; 1x hose nozzle
Consumables	Screw cap GL 18 with hole (package of 10 pieces) (BBI-44130452) Olive, curved, GL 18 (BBI-44430101)
Related Products	Hose connection set vessel GL 18 (BBI-44430111) Screw cap GL 18 with hole (package of 10 pieces) (BBI-44130452) Seal for screw cap GL 18 (package of 10 pieces) (BBI-44130453)
<p>Description:</p> <ul style="list-style-type: none"> • Screw cap GL 18 with central hole and hose nozzle • Red • For jacketed glass vessels • Hose nozzle for GL 18 also available separately • Usable up to 180°C 	



Alle / Verkaufsartikel / Accessories / Addition / Screw caps

Screw Cap GL 45 (package of 10 pieces)



bbi Scancode	BBI-44130460
Internal Thread	GL 45
Country of Origin	DE 
HS-Code	39235010
Weight	0.16 kg
Material	PBT

Components	10x screw cap
Related Products	<p>Screw cap GL 45 with hole, blue (package of 10 pieces) (BBI-44130471)</p> <p>Screw cap GL 45 with hole, red (package of 10 pieces) (BBI-44130450)</p> <p>Seal for screw cap GL 45 (package of 10 pieces) (BBI-44130451)</p>
<p>Description:</p> <ul style="list-style-type: none"> • Screw cap GL 45 • For corrective media bottles • Usable up to 180°C 	



Alle / Verkaufsartikel / Accessories / Addition / Screw caps

Screw cap GL 32 with hole (package of 10 pieces)



bbi Scancode	BBI-44130461
Internal Thread	GL 32
HS-Code	39235010
Weight	0.16 kg
Material	PBT

Components	10x screw cap
Related Products	<p>Screw cap GL 14 with hole (package of 10 pieces) (BBI-44130457)</p> <p>Screw cap GL 45 with hole (set: red, yellow, green, blue) (BBI-44130473)</p> <p>Seal for screw cap GL 32 (package of 10 pieces) (BBI-44130462)</p>
<p>Description:</p> <ul style="list-style-type: none"> • Screw cap GL 25 with central hole Ø 20 mm • Red • Usable up to 180°C • Package: 10 pieces 	



Alle / Verkaufsartikel / Accessories / Addition / Screw caps

Screw cap GL 45 with hole, green (package of 10 pieces)



bbi Scancode	BBI-44130470
Manufacturer	bbi-biotech GmbH
Internal Thread	GL 45
Country of Origin	DE 
HS-Code	39235010
Weight	0.11 kg
Material	PBT

Components	10x screw cap
Related Products	<p>Screw cap GL 45 with hole (set: red, yellow, green, blue) (BBI-44130473)</p> <p>Screw cap GL 45 with hole, blue (package of 10 pieces) (BBI-44130471)</p> <p>Screw cap GL 45 with hole, yellow (package of 10 pieces) (BBI-44130472)</p>

Description:

- Screw cap GL 45 with central hole \varnothing 34 mm
- Green
- For corrective media bottles
- For use with headpieces and seals (available separately)
- Usable up to 180°C
- Package: 10 pieces



To the Shop:



Alle / Verkaufsartikel / Accessories / Addition / Screw caps

Screw cap GL 45 with hole, blue (package of 10 pieces)



bbi Scancode	BBI-44130471
Manufacturer	bbi-biotech GmbH
Internal Thread	GL 45
Country of Origin	DE 
HS-Code	39235010
Weight	0.11 kg
Material	PBT

Components	10x screw cap
Related Products	Screw cap GL 45 with hole (set: red, yellow, green, blue) (BBI-44130473) Screw cap GL 45 with hole, green (package of 10 pieces) (BBI-44130470) Screw cap GL 45 with hole, red (package of 10 pieces) (BBI-44130450)

Description:

- Screw cap GL 45 with central hole \varnothing 34 mm
- Blue
- For corrective media bottles
- For use with headpieces and seals (available separately)
- Usable up to 180°C
- Package: 10 pieces



To the Shop:



Alle / Verkaufsartikel / Accessories / Addition / Screw caps

Screw cap GL 45 with hole, yellow (package of 10 pieces)



bbi Scancode	BBI-44130472
Manufacturer	bbi-biotech GmbH
Internal Thread	GL 45
Country of Origin	DE 
HS-Code	39235010
Weight	0.11 kg
Material	PBT

Components	10x screw cap
Related Products	<p>Screw cap GL 45 with hole (set: red, yellow, green, blue) (BBI-44130473)</p> <p>Screw cap GL 45 with hole, green (package of 10 pieces) (BBI-44130470)</p> <p>Screw cap GL 45 with hole, red (package of 10 pieces) (BBI-44130450)</p>

Description:

- Screw cap GL 45 with central hole \varnothing 34 mm
- Yellow
- For corrective media bottles
- For use with headpieces and seals (available separately)
- Usable up to 180°C
- Package: 10 pieces



To the Shop:



Alle / Verkaufsartikel / Accessories / Addition / Screw caps

Screw cap GL 45 with hole (set: red, yellow, green, blue)



bbi Scancode	BBI-44130473
Manufacturer	bbi-biotech GmbH
Internal Thread	GL 45
Country of Origin	DE 
HS-Code	39235010
Material	PBT

Components	4x screw cap
Related Products	<p>Screw cap GL 45 with hole, blue (package of 10 pieces) (BBI-44130471)</p> <p>Screw cap GL 45 with hole, green (package of 10 pieces) (BBI-44130470)</p> <p>Screw cap GL 45 with hole, red (package of 10 pieces) (BBI-44130450)</p>
<p>Description:</p> <ul style="list-style-type: none"> • Screw cap GL 45 with central hole \varnothing 34 mm • Red, yellow, green, blue • For corrective media bottles • For use with headpieces and seals (available separately) • Usable up to 180°C • Package: 4 pieces 	



Alle / Verkaufsartikel / Accessories / Addition / Screw caps

Olive, curved, GL 14



bbi Scancode	BBI-44430100
Country of Origin	DE 
HS-Code	39269097
Material	PP with silicone rubber seal

Components	1x olive
Related Products	Hose connection set vessel GL 14 (BBI-44430110) Olive, curved, GL 18 (BBI-44430101) Screw cap GL 14 with hose nozzle (BBI-44130458)
Description: <ul style="list-style-type: none"> • 8.6 mm spout • ID = 4 mm • Autoclavable; temperature resistant from -40 to +140 °C • For screw caps with holes and GL 14 thread 	



To the Shop:



Alle / Verkaufsartikel / Accessories / Addition / Screw caps

Olive, curved, GL 18



bbi Scancode	BBI-44430101
Country of Origin	DE 
HS-Code	39269097
Material	PP with silicone rubber seal

Components	1x olive
Related Products	Hose connection set vessel GL 18 (BBI-44430111) Olive, curved, GL 14 (BBI-44430100) Screw cap GL 18 with hose nozzle (BBI-44130459)
Description: <ul style="list-style-type: none"> • 10.8 mm spout • ID = 6.8 mm • Autoclavable; temperature resistant from -40 to +140 °C • For screw caps with holes and GL 18 thread 	



To the Shop:



Alle / Verkaufsartikel / Accessories / Addition / Sterile sleeves

Sterile sleeve Rd 28 × 1/8



bbi Scancode	BBI-44130013
Manufacturer	bbi-biotech GmbH
Internal Thread	Rd 28 × 1/8
Country of Origin	DE 
HS-Code	73269098
Weight	0.39 kg
Material	Stainless steel 316L

Components	1x sterile sleeve; 1x glass fiber sterile barrier [BBI-44130911]
Consumables	Glass wool (BBI-44130911)
Related Products	Glass wool (BBI-44130911) Sterile sleeve M 26 x 1 (BBI-44130019) Sterile sleeve Tri-Clamp 25 mm (BBI-44130014)

Description:

- Accessory for autoclaving
- Used for autoclaving additionports, inoculation ports, exhaust cooler, etc. with Rd 28 x 1/8 thread
- Detachable cap
- Glass fiber filling for sterile barrier during autoclaving or in-situ
- Also used for in-situ Rd 28 x 1/8 external flanges



To the Shop:



Alle / Verkaufsartikel / Accessories / Addition / Sterile sleeves

Sterile sleeve Tri-Clamp 25 mm



bbi Scancode	BBI-44130014
Manufacturer	bbi-biotech GmbH
Country of Origin	DE 
HS-Code	73269098
Weight	0.25 kg
Material	Stainless steel 316L

Components	1x sterile sleeve; 1x glass fiber sterile barrier [BBI-44130911]
Consumables	Glass wool (BBI-44130911) O-ring for items to install in M 26 x 1 ports (package of 10 pieces) (BBI-45100015)
Related Products	Glass wool (BBI-44130911) Sterile sleeve M 26 x 1 (BBI-44130019) Sterile sleeve Rd 28 x 1/8 (BBI-44130013)

Description:

- Accessory for autoclaving
- For the use with Tri-Clamp 25 mm fittings
- Used for autoclaving addition ports, Inoculation ports, exhaust cooler, etc. with Tri-Clamp 25 mm
- Detachable cap
- Glass fiber filling for sterile barrier during autoclaving or in-situ



To the Shop:



Alle / Verkaufsartikel / Accessories / Addition / Sterile sleeves

Sterile sleeve M 26 x 1



bbi Scancode	BBI-44130019
Manufacturer	bbi-biotech GmbH
Internal Thread	M 26 x 1
Country of Origin	DE 
HS-Code	73269098
Weight	0.37 kg

Components	1x sterile sleeve; 1x glass fiber sterile barrier [BBI-44130911]
Consumables	Glass wool (BBI-44130911)
Related Products	Glass wool (BBI-44130911) Sterile sleeve Rd 28 x 1/8 (BBI-44130013) Sterile sleeve Tri-Clamp 25 mm (BBI-44130014)

Description:

- Accessory for autoclaving
- Used for autoclaving additionports, inoculation ports, exhaust cooler, etc. with M26x1 thread
- Detachable cap
- Glass fiber filling for sterile barrier during autoclaving or in-situ



To the Shop:



Alle / Verkaufsartikel / Accessories / Addition / Sterile sleeves

Glass wool



bbi Scancode	BBI-44130911
Manufacturer	bbi-biotech GmbH
Country of Origin	DE 
HS-Code	70198090
Material	Filter glass wool

Components	1x package glass wool
Related Products	1-way addition port Ø 4 mm, Rd 28 x 1/8 (BBI-43630106) Sterile sleeve M 26 x 1 (BBI-44130019) Sterile sleeve Rd 28 x 1/8 (BBI-44130013)
<p>Description:</p> <ul style="list-style-type: none"> • E.g. for sterile sleeves • 11 µm (filter glass wool) • 500 g 	



Alle / Verkaufsartikel / Accessories / Culture vessels / Equipped glass vessels

5 L double-wall stainless steel vessel, complete with accessories MO without sensors



bbi Scancode	BBI-44436050
Manufacturer	bbi-biotech GmbH
Material Certificate	3.1, Rauigkeit, FDA
Country of Origin	DE 
Material	Stainless steel 316L EPDM black borosilicate glass div.

Components	
Related Products	<p>5 L double-wall vessel, complete with 2 spargers CC and accessories without sensors (BBI-44439051)</p> <p>5 L double-wall vessel, complete with accessories CC without sensors (BBI-44439050)</p> <p>5 L double-wall vessel, complete with accessories MO without sensors (BBI-44438050)</p>
Description:	



Alle / Verkaufsartikel / Accessories / Culture vessels / Equipped glass vessels

2 L single-wall vessel, complete with accessories CC without sensors and heating jacket



bbi Scancode	BBI-44437020
Manufacturer	bbi-biotech GmbH
Material Certificate	3.1, Rauigkeit, FDA
Country of Origin	DE 
Weight	14,28 kg
Material	Stainless steel 316L EPDM black borosilicate glass div.

Components

1x 2 L stainless steel stand [BBI-44430021] 1x 2 L lid [BBI-44430022] 1x 2 L single-wall vessel [BBI-44430302] 1x 2 L stirrer shaft, 10 mm [BBI-43230041] 1x powergrip coupling for 10 mm- stirrer shaft [BBI-44430402] 2x 2 L 3-bladed segment impeller [BBI-43230304] 1x 2 L exhaust cooler M 26 x 1 [BBI-43930005] 1x 4-fold addition port, M 26 x 1 [BBI-43630202] 4x blind plug Pg 13.5 [BBI-44130206] 5x blind plug M 10 x 1 [BBI-44130207] 1x 2 L harvest pipe fixed, Di = 4 mm, M 10 x 1 [BBI-43630012] 1x inoculation port with septa for 11 mm port [BBI-43630200] 1x universal adapter 6-4 [BBI-43930003] 1x 2 L Pt100 casing [BBI-43430004] 1x Pt100 temperature sensor, 1 m [BBI-43430020] 2x adapter for 6 mm level probes or dip tubes for harvesting in 11 mm ports [BBI-44630103] 1x antifoam or level probe L=100 mm [BBI-44630003] 1x cable for antifoam or level probe [BBI-44630010] 1x 2 L microsparger without frit [BBI-43530202] 1x Frit, G 1/8, 20 µm [BBI-43530050] 1x 2 L harvest pipe flex, Di = 4 mm, without adapter [BBI-43630037] 1x equipotential bonding cable [BBI-44640980] 1x Consumable starter set autoclavables [BBI-45110100]



To the Shop:



<p>Consumables</p>	<p>Support for glass vessel (BBI-44430203) Lid screw (BBI-44430052) Grounding screw (for lid) (BBI-44430053) Wear parts for stirrer shafts up to 10 L (BBI-60000205) Replacement-connection-kit exhaust cooler (BBI-43930201) Silicone tube 3.2 x 1.6 mm (package with 5 m) (BBI-44130605) Innovaprene tube (ID x WT: 0.5 mm x 1.0 mm) (package of 5 m) (BBI-44130613) Sterile filter 30 mm 0.2 µm (package of 10 pieces) (BBI-44130510) Silicone tube 1.6 x 1.6 mm (package with 5 m) (BBI-44130604) Silicone tube 2.0 x 1.0 mm (package with 5 m) (BBI-44130612) Sterile filter gas 50 mm (BBI-44130511) Membrane/septa for inoculation port or manual bypass sampler (package of 10 pieces) (BBI-43830001) Stainless steel fitting grease, 5 ml (BBI-44130902) Clamping cone (Package of 5 pieces) (BBI-44130017) Flat seal with hole for 12 mm ports (package of 5 pieces) (BBI-44130214) Flat seal for 12 mm ports (Package of 5 pieces) (BBI-44130210) Gasket TC25 for hose connector exhaust cooler (package of 5 pieces) (BBI-45100302) O-ring for items to install in 11 mm ports (package of 10 pieces) (BBI-45100011) O-ring for items to install in M 26 x 1 ports (package of 10 pieces) (BBI-45100015) O-ring for adapter (package of 5 pieces) (BBI-45100025) Silicone grease, 5 ml (BBI-44130901)</p>
<p>Related Products</p>	<p>2 L single-wall vessel, complete with accessories CC without sensors (BBI-44439022) 2 L vessel DW complete with 2 spargers CC and standard accessories without sensors (BBI-44439021) 2 L vessel SW complete with 2 spargers CC without sensors and heating jacket (BBI-44437021)</p>
<p>Description:</p>	



Alle / Verkaufsartikel / Accessories / Culture vessels / Equipped glass vessels

2 L vessel SW complete with 2 spargers CC without sensors and heating jacket



bbi Scancode	BBI-44437021
Manufacturer	bbi-biotech GmbH
Material Certificate	3.1, Rauigkeit, FDA
Country of Origin	DE 
Material	Stainless steel 316L EPDM black borosilicate glass div.

Components

1x 2 L stainless steel stand [BBI-44430021] 1x 2 L lid [BBI-44430022] 1x 2 L single-wall vessel [BBI-44430302] 1x 2 L stirrer shaft, 10 mm [BBI-43230041] 1x powergrip coupling for 10 mm- stirrer shaft [BBI-44430402] 2x 2 L 3-bladed segment impeller [BBI-43230304] 1x 2 L exhaust cooler M 26 x 1 [BBI-43930005] 1x 4-fold addition port, M 26 x 1 [BBI-43630202] 4x blind plug Pg 13.5 [BBI-44130206] 5x blind plug M 10 x 1 [BBI-44130207] 1x 2 L harvest pipe fixed, Di = 4 mm, M 10 x 1 [BBI-43630012] 1x inoculation port with septa for 11 mm port [BBI-43630200] 1x universal adapter 6-4 [BBI-43930003] 1x 2 L Pt100 casing [BBI-43430004] 1x Pt100 temperature sensor, 1 m [BBI-43430020] 2x adapter for 6 mm level probes or dip tubes for harvesting in 11 mm ports [BBI-44630103] 1x antifoam or level probe L=100 mm [BBI-44630003] 1x cable for antifoam or level probe [BBI-44630010] 1x 2 L ringsparger, downward-facing holes [BBI-43530089] 1x 2 L microsparger without frit [BBI-43530202] 1x Frit, G 1/8, 20 µm [BBI-43530050] 1x 2 L harvest pipe flex, Di = 4 mm, without adapter [BBI-43630037] 1x equipotential bonding cable [BBI-44640980] 1x Consumable starter set autoclavables [BBI-45110100]

Related Products

2 L double-wall vessel, complete with accessories CC without sensors (BBI-44439020)
 2 L single-wall vessel, complete with accessories CC without sensors (BBI-44439022)
 2 L vessel DW complete with 2 spargers CC and standard accessories without sensors (BBI-44439021)

Description:



To the Shop:



Alle / Verkaufsartikel / Accessories / Culture vessels / Equipped glass vessels

5 L vessel SW complete with standard accessories CC without sensors and heating jacket



bbi Scancode	BBI-44437050
Manufacturer	bbi-biotech GmbH
Material Certificate	3.1, Rauigkeit, FDA
Country of Origin	DE 
Material	Stainless steel 316L EPDM black borosilicate glass div.

Components	1x 5 L stainless steel stand [BBI-44430031] 1x 5 L lid [BBI-44430032] 1x 5 L single-wall vessel [BBI-44430303] 1x 5 L stirrer shaft, 10 mm [BBI-43230046] 1x powergrip coupling for 10 mm- stirrer shaft [BBI-44430402] 2x 5 L 3-bladed segment impeller [BBI-43230305] 1x 4-fold addition port, M 26 x 1 [BBI-43630202] 1x 5-10 L exhaust cooler M 26 x 1 [BBI-43930007] 1x blind plug for 19 mm ports M 26 x 1 [BBI-444130201] 4x blind plug Pg 13.5 [BBI-44130206] 1x universal adapter 6-4 [BBI-43930003] 1x 5 L microsparger without frit [BBI-43530203] 1x Frit, G 1/8, 20 µm [BBI-43530050] 5x blind plug M 10 x 1 [BBI-44130207] 1x 5 L harvest pipe fixed, Di = 4 mm, M 10 x 1 [BBI-43630005] 2x adapter for 6 mm level probes or dip tubes for harvesting in 11 mm ports [BBI-44630103] 1x 5 L harvest pipe flex, Di = 4 mm, without adapter [BBI-43630038] 1x inoculation port with septa for 11 mm port [BBI-43630200] 1x antifoam or level probe L=100 mm [BBI-44630003] 1x cable for antifoam or level probe [BBI-44630010] 1x 5 L Pt100 casing [BBI-43430005] 1x Pt100 temperature sensor, 1 m [BBI-43430020] 1x equipotential bonding cable [BBI-44640980] 1x Consumable starter set autoclavables [BBI-45110100]
Related Products	5 L double-wall vessel, complete with accessories CC without sensors (BBI-44439050) 5 L double-wall vessel, complete with accessories MO without sensors (BBI-44438050) 5 L vessel SW complete with 2 spargers CC without sensors and heating jacket (BBI-44437051)
Description:	



To the Shop:



Alle / Verkaufsartikel / Accessories / Culture vessels / Equipped glass vessels

5 L vessel SW complete with 2 spargers CC without sensors and heating jacket



bbi Scancode	BBI-44437051
Manufacturer	bbi-biotech GmbH
Material Certificate	3.1, Rauigkeit, FDA
Country of Origin	DE 
Material	Stainless steel 316L EPDM black borosilicate glass div.

Components	1x 5 L stainless steel stand [BBI-44430031] 1x 5 L lid [BBI-44430032] 1x 5 L single-wall vessel [BBI-44430303] 1x 5 L stirrer shaft, 10 mm [BBI-43230046] 1x powergrip coupling for 10 mm- stirrer shaft [BBI-44430402] 2x 5 L 3-bladed segment impeller [BBI-43230305] 1x 4-fold addition port, M 26 x 1 [BBI-43630202] 1x 5-10 L exhaust cooler M 26 x 1 [BBI-43930007] 1x blind plug for 19 mm ports M 26 x 1 [BBI-444130201] 4x blind plug Pg 13.5 [BBI-44130206] 1x universal adapter 6-4 [BBI-43930003] 1x 5 L ring sparger, downwards-facing holes with 0.5 mm [BBI-43530090] 1x 5 L microsparger without frit [BBI-43530203] 1x Frit, G 1/8, 20 µm [BBI-43530050] 4x blind plug M 10 x 1 [BBI-44130207] 1x 5 L harvest pipe fixed, Di = 4 mm, M 10 x 1 [BBI-43630005] 2x adapter for 6 mm level probes or dip tubes for harvesting in 11 mm ports [BBI-44630103] 1x 5 L harvest pipe flex, Di = 4 mm, without adapter [BBI-43630038] 1x inoculation port with septa for 11 mm port [BBI-43630200] 1x antifoam or level probe L=100 mm [BBI-44630003] 1x cable for antifoam or level probe [BBI-44630010] 1x 5 L Pt100 casing [BBI-43430005] 1x Pt100 temperature sensor, 1 m [BBI-43430020] 1x equipotential bonding cable [BBI-44640980] 1x Consumable starter set autoclavables [BBI-45110100]
Related Products	5 L double-wall vessel, complete with 2 spargers CC and accessories without sensors (BBI-44439051) 5 L double-wall vessel, complete with accessories CC without sensors (BBI-44439050) 5 L double-wall vessel, complete with accessories MO without sensors (BBI-44438050)
Description:	



To the Shop:



Alle / Verkaufsartikel / Accessories / Culture vessels / Equipped glass vessels

10 L vessel SW complete with standard accessories CC without sensors and heating jacket



bbi Scancode	BBI-44437100
Manufacturer	bbi-biotech GmbH
Material Certificate	3.1, Rauigkeit, FDA
Material	Stainless steel 316L EPDM black borosilicate glass div.

Components

1x 10 L stainless steel stand [BBI-44430041] 1x 10 L lid [BBI-44430042] 1x 10 L single-wall vessel [BBI-44430304] 1x 10 L stirrer shaft, 16 mm [BBI-43230044] 1x powergrip coupling for 10 mm- stirrer shaft [BBI-44430402] 3x 10 L 3-bladed segment impeller [BBI-43230306] 1x 5-10 L exhaust cooler M 26 x 1 [BBI-43930007] 1x 4-fold addition port, M 26 x 1 [BBI-43630202] 1x blind plug for 19 mm ports M 26 x 1 [BBI-44130201] 5x blind plug Pg 13.5 [BBI-44130206] 6x blind plug M 10 x 1 [BBI-44130207] 1x 10 L Pt100 casing [BBI-43430006] 1x Pt100 temperature sensor, 1 m [BBI-43430020] 1x 10 L harvest pipe fixed, Di = 4 mm, M 10 x 1 [BBI-43630014] 2x adapter for 6 mm level probes or dip tubes for harvesting in 11 mm ports [BBI-44630103] 1x antifoam or level probe L=100 mm [BBI-44630003] 1x cable for antifoam or level probe [BBI-44630010] 1x 10 L microsparger without frit [BBI-43530204] 1x Frit, G 1/8, 20 µm [BBI-43530050] 1x inoculation port with septa for 11 mm port [BBI-43630200] 1x universal adapter 6-4 [BBI-43930003] 1x 10 L harvest pipe flex, Di = 4 mm, without adapter [BBI-43630039] 1x equipotential bonding cable [BBI-44640980] 1x Consumable starter set autoclavables [BBI-45110100]

Description:



To the Shop:



Alle / Verkaufsartikel / Accessories / Culture vessels / Equipped glass vessels

0.5 L double-wall vessel, complete with accessories MO without sensors



bbi Scancode	BBI-44438005
Manufacturer	bbi-biotech GmbH
Material Certificate	3.1, Rauigkeit, FDA
Country of Origin	DE 
Material	Stainless steel 316L EPDM black borosilicate glass div.

Components

1x 0.5 L stainless steel stand [BBI-44430001] 1x 0.5 L lid [BBI-44430002] 1x 0.5 L jacketed glass vessel [BBI-44430004] 1x 0.5 L stirrer shaft, 8 mm [BBI-43230042] 1x powergrip coupling for 10 mm- stirrer shaft [BBI-44430402] 2x 0.5 L Rushton impeller [BBI-43230322] 1x blind plug for 19 mm ports M 26 x 1 [BBI-44130201] 1x 3-fach Zugabestutzen 4 mm, PG 13,5 [BBI-43630252] 1x 0.5-1 L exhaust cooler Pg 13.5 [BBI-43930009] 1x blind plug Pg 13.5 [BBI-44130206] 1x inoculation port with septa for 11 mm port [BBI-43630200] 1x universal adapter 6-4 [BBI-43930003] 1x 0.5 L harvest pipe fixed, Di = 4 mm, M 10 x 1 [BBI-43630023] 1x blind plug M 10 x 1 [BBI-44130207] 1x 0.5 L Pt100 casing [BBI-43430007] 1x Pt100 temperature sensor, 1 m [BBI-43430020] 1x 0.5 L ring sparger, downwards-facing holes with 0.5 mm [BBI-43530087] 2x adapter for 6 mm level probes or dip tubes for harvesting in 11 mm ports [BBI-44630103] 1x antifoam or level probe L=100 mm [BBI-44630003] 1x cable for antifoam or level probe [BBI-44630010] 1x 0.5 L harvest pipe flex, Di = 4 mm, without adapter [BBI-43630035] 1x equipotential bonding cable [BBI-44640980] 1x hose connection set vessel GL 14 [BBI-44430110] 1x consumable starter set autoclavables [BBI-45110100]



To the Shop:



<p>Consumables</p>	<p>Support for glass vessel (BBI-44430203) Lid screw (BBI-44430052) Grounding screw (for lid) (BBI-44430053) Wear parts for stirrer shafts up to 10 L (BBI-60000205) Replacement-connection-kit exhaust cooler (BBI-43930201) Silicone tube 3.2 x 1.6 mm (package with 5 m) (BBI-44130605) Innovaprene tube (ID x WT: 0.5 mm x 1.0 mm) (package of 5 m) (BBI-44130613) Sterile filter 30 mm 0.2 µm (package of 10 pieces) (BBI-44130510) Silicone tube 1.6 x 1.6 mm (package with 5 m) (BBI-44130604) Silicone tube 2.0 x 1.0 mm (package with 5 m) (BBI-44130612) Sterile filter gas 50 mm (BBI-44130511) Membrane/septa for inoculation port or manual bypass sampler (package of 10 pieces) (BBI-43830001) Stainless steel fitting grease, 5 ml (BBI-44130902) Clamping cone (Package of 5 pieces) (BBI-44130017) Flat seal with hole for 12 mm ports (package of 5 pieces) (BBI-44130214) Flat seal for 12 mm ports (Package of 5 pieces) (BBI-44130210) Gasket TC25 for hose connector exhaust cooler (package of 5 pieces) (BBI-45100302) O-ring for items to install in 11 mm ports (package of 10 pieces) (BBI-45100011) O-ring for items to install in M 26 x 1 ports (package of 10 pieces) (BBI-45100015) O-ring for adapter (package of 5 pieces) (BBI-45100025) Silicone grease, 5 ml (BBI-44130901)</p>
<p>Related Products</p>	<p>0.5 L Rushton impeller (BBI-43230322) 0.5 L double-wall vessel, complete with accessories CC without sensors (BBI-44439005) 0.5 L ring sparger, downwards-facing holes with 0.5 mm (BBI-43530087)</p>
<p>Description:</p>	



Alle / Verkaufsartikel / Accessories / Culture vessels / Equipped glass vessels

1 L double-wall vessel, complete with accessories MO without sensors



bbi Scancode	BBI-44438010
Manufacturer	bbi-biotech GmbH
Material Certificate	3.1, Raugkeit, FDA
Country of Origin	DE 
Material	Stainless steel 316L EPDM black borosilicate glass div.

Components

1x 1 L stainless steel stand [BBI-44430011] 1x 1 L lid [BBI-44430012] 1x 1 L jacketed glass vessel [BBI-44430014] 1x 1 L stirrer shaft, 10 mm [BBI-43230040] 1x powergrip coupling for 10 mm- stirrer shaft [BBI-44430402] 2x 1 L Rushton impeller [BBI-43230323] 1x 4-fold addition port, M 26 x 1 [BBI-43630202] 1x 0.5-1 L exhaust cooler, Pg 13,5 [BBI-43930009] 3x blind plug Pg 13.5 [BBI-44430206] 1x 1 L harvest pipe fixed, Di = 4 mm, M 10 x 1 [BBI-43630013] 2x adapter for 6 mm level probes or dip tubes for harvesting in 11 mm ports [BBI-44630103] 1x 1 L harvest pipe flex, Di = 4 mm, without adapter [BBI-43630036] 1x 1 L baffle [BBI-43230031] 1x antifoam or level probe L=100 mm [BBI-44630003] 1x cable for antifoam or level probe [BBI-44630010] 1x universal adapter 6-4 [BBI-43930003] 1x 1 L Pt100 casing [BBI-43430021] 1x Pt100 temperature sensor, 1 m [BBI-43430020] 1x inoculation port with septa for 11 mm port [BBI-43630200] 1x 1 L ringsparger, downward-facing holes [BBI-43530088] 1x equipotential bonding cable [BBI-44640980] 1x hose connection set vessel GL 14 [BBI-44430110] 1x consumable starter set autoclavables [BBI-45110100]



To the Shop:



<p>Consumables</p>	<p>Support for glass vessel (BBI-44430203) Lid screw (BBI-44430052) Grounding screw (for lid) (BBI-44430053) Wear parts for stirrer shafts up to 10 L (BBI-60000205) Replacement-connection-kit exhaust cooler (BBI-43930201) Silicone tube 3.2 x 1.6 mm (package with 5 m) (BBI-44130605) Innovaprene tube (ID x WT: 0.5 mm x 1.0 mm) (package of 5 m) (BBI-44130613) Sterile filter 30 mm 0.2 µm (package of 10 pieces) (BBI-44130510) Silicone tube 1.6 x 1.6 mm (package with 5 m) (BBI-44130604) Silicone tube 2.0 x 1.0 mm (package with 5 m) (BBI-44130612) Sterile filter gas 50 mm (BBI-44130511) Membrane/septa for inoculation port or manual bypass sampler (package of 10 pieces) (BBI-43830001) Stainless steel fitting grease, 5 ml (BBI-44130902) Clamping cone (Package of 5 pieces) (BBI-44130017) Flat seal with hole for 12 mm ports (package of 5 pieces) (BBI-44130214) Flat seal for 12 mm ports (Package of 5 pieces) (BBI-44130210) Gasket TC25 for hose connector exhaust cooler (package of 5 pieces) (BBI-45100302) O-ring for items to install in 11 mm ports (package of 10 pieces) (BBI-45100011) O-ring for items to install in M 26 x 1 ports (package of 10 pieces) (BBI-45100015) O-ring for adapter (package of 5 pieces) (BBI-45100025) Silicone grease, 5 ml (BBI-44130901)</p>
<p>Related Products</p>	<p>1 L double-wall vessel, complete with accessories CC without sensors (BBI-44439010) 1 L single-wall vessel, complete with accessories CC without sensors and heating jacket (BBI-44437010) 1 L vessel DW complete with 2 spargers CC without sensors (BBI-44439011)</p>
<p>Description:</p>	



Alle / Verkaufsartikel / Accessories / Culture vessels / Equipped glass vessels

2 L double-wall vessel, complete with accessories MO without sensors



bbi Scancode	BBI-44438020
Manufacturer	bbi-biotech GmbH
Material Certificate	3.1, Rauigkeit, FDA
Country of Origin	DE 
Weight	14.28 kg
Material	Stainless steel 316L EPDM black borosilicate glass div.

Components

1x 2 L stainless steel stand [BBI-44430021] 1x 2 L lid [BBI-44430022] 1x 2 L jacketed glass vessel [BBI-44430024] 1x 2 L stirrer shaft, 10 mm [BBI-43230041] 1x powergrip coupling for 10 mm- stirrer shaft [BBI-44430402] 2x 2 L Rushton impeller [BBI-43230324] 1x 2 L exhaust cooler M 26 x 1 [BBI-43930005] 1x 4-fold addition port, M 26 x 1 [BBI-43630202] 4x blind plug Pg 13.5 [BBI-444130206] 4x blind plug M 10 x 1 [BBI-444130207] 1x 2 L baffle [BBI-43230032] 1x 2 L harvest pipe fixed, Di = 4 mm, M 10 x 1 [BBI-43630012] 1x inoculation port with septa for 11 mm port [BBI-43630200] 1x universal adapter 6-4 [BBI-43930003] 1x 2 L Pt100 casing [BBI-43430004] 1x Pt100 temperature sensor, 1 m [BBI-43430020] 2x adapter for 6 mm level probes or dip tubes for harvesting in 11 mm ports [BBI-44630103] 1x antifoam or level probe L=100 mm [BBI-44630003] 1x cable for antifoam or level probe [BBI-44630010] 1x 2 L ring sparger, downwards-facing holes with 0.5 mm [BBI-43530089] 1x 2 L harvest pipe flex, Di = 4 mm, without adapter [BBI-43630037] 1x equipotential bonding cable [BBI-44640980] 1x hose connection set vessel GL 14 [BBI-44430110] 1x consumable starter set autoclavables [BBI-45110100]



To the Shop:



<p>Consumables</p>	<p>Support for glass vessel (BBI-44430203) Lid screw (BBI-44430052) Grounding screw (for lid) (BBI-44430053) Wear parts for stirrer shafts up to 10 L (BBI-60000205) Replacement-connection-kit exhaust cooler (BBI-43930201) Silicone tube 3.2 x 1.6 mm (package with 5 m) (BBI-44130605) Innovaprene tube (ID x WT: 0.5 mm x 1.0 mm) (package of 5 m) (BBI-44130613) Sterile filter 30 mm 0.2 µm (package of 10 pieces) (BBI-44130510) Silicone tube 1.6 x 1.6 mm (package with 5 m) (BBI-44130604) Silicone tube 2.0 x 1.0 mm (package with 5 m) (BBI-44130612) Sterile filter gas 50 mm (BBI-44130511) Membrane/septa for inoculation port or manual bypass sampler (package of 10 pieces) (BBI-43830001) Stainless steel fitting grease, 5 ml (BBI-44130902) Clamping cone (Package of 5 pieces) (BBI-44130017) Flat seal with hole for 12 mm ports (package of 5 pieces) (BBI-44130214) Flat seal for 12 mm ports (Package of 5 pieces) (BBI-44130210) Gasket TC25 for hose connector exhaust cooler (package of 5 pieces) (BBI-45100302) O-ring for items to install in 11 mm ports (package of 10 pieces) (BBI-45100011) O-ring for items to install in M 26 x 1 ports (package of 10 pieces) (BBI-45100015) O-ring for adapter (package of 5 pieces) (BBI-45100025) Silicone grease, 5 ml (BBI-44130901)</p>
<p>Related Products</p>	<p>2 L double-wall vessel, complete with accessories CC without sensors (BBI-44439020) 2 L single-wall vessel, complete with accessories CC without sensors (BBI-44439022) 2 L vessel DW complete with 2 spargers CC and standard accessories without sensors (BBI-44439021)</p>
<p>Description:</p>	



Alle / Verkaufsartikel / Accessories / Culture vessels / Equipped glass vessels

5 L double-wall vessel, complete with accessories MO without sensors



bbi Scancode	BBI-44438050
Manufacturer	bbi-biotech GmbH
Material Certificate	3.1, Raugkeit, FDA
Country of Origin	DE 
Weight	22.75 kg
Material	Stainless steel 316L EPDM black borosilicate glass div.

Components

1x 5 L stainless steel stand [BBI-44430031] 1x 5 L lid [BBI-44430032] 1x 5 L jacketed glass vessel [BBI-44430034] 1x 5 L stirrer shaft, 10 mm [BBI-43230046] 1x powergrip coupling for 10 mm- stirrer shaft [BBI-44430402] 2x 5 L Rushton impeller [BBI-43230325] 1x 4-fold addition port, M 26 x 1 [BBI-43630202] 1x 5-10 L exhaust cooler M 26 x 1 [BBI-43930007] 1x blind plug for 19 mm ports M 26 x 1 [BBI-44130201] 4x blind plug Pg 13.5 [BBI-44130206] 1x universal adapter 6-4 [BBI-43930003] 1x 5 L ring sparger, downwards-facing holes with 0.5 mm [BBI-43530090] 3x blind plug M 10 x 1 [BBI-44130207] 1x 5 L baffle [BBI-43230033] 1x 5 L harvest pipe fixed, Di = 4 mm, M 10 x 1 [BBI-43630005] 2x adapter for 6 mm level probes or dip tubes for harvesting in 11 mm ports [BBI-44630103] 1x 5 L harvest pipe flex, Di = 4 mm, without adapter [BBI-43630038] 1x inoculation port with septa for 11 mm port [BBI-43630200] 1x antifoam or level probe L=100 mm [BBI-44630003] 1x cable for antifoam or level probe [BBI-44630010] 1x 5 L Pt100 casing [BBI-43430005] 1x Pt100 temperature sensor, 1 m [BBI-43430020] 1x equipotential bonding cable [BBI-44640980] 1x hose connection set vessel GL 18 [BBI-44430111] 1x consumable starter set autoclavables [BBI-45110100]



To the Shop:



<p>Consumables</p>	<p>Support for glass vessel (BBI-44430203) Lid screw (BBI-44430052) Grounding screw (for lid) (BBI-44430053) Wear parts for stirrer shafts up to 10 L (BBI-60000205) Replacement-connection-kit exhaust cooler (BBI-43930201) Silicone tube 3.2 x 1.6 mm (package with 5 m) (BBI-44130605) Innovaprene tube (ID x WT: 0.5 mm x 1.0 mm) (package of 5 m) (BBI-44130613) Sterile filter 30 mm 0.2 µm (package of 10 pieces) (BBI-44130510) Silicone tube 1.6 x 1.6 mm (package with 5 m) (BBI-44130604) Silicone tube 2.0 x 1.0 mm (package with 5 m) (BBI-44130612) Sterile filter gas 50 mm (BBI-44130511) Membrane/septa for inoculation port or manual bypass sampler (package of 10 pieces) (BBI-43830001) Stainless steel fitting grease, 5 ml (BBI-44130902) Clamping cone (Package of 5 pieces) (BBI-44130017) Flat seal with hole for 12 mm ports (package of 5 pieces) (BBI-44130214) Flat seal for 12 mm ports (Package of 5 pieces) (BBI-44130210) Gasket TC25 for hose connector exhaust cooler (package of 5 pieces) (BBI-45100302) O-ring for items to install in 11 mm ports (package of 10 pieces) (BBI-45100011) O-ring for items to install in M 26 x 1 ports (package of 10 pieces) (BBI-45100015) O-ring for adapter (package of 5 pieces) (BBI-45100025) Silicone grease, 5 ml (BBI-44130901)</p>
<p>Related Products</p>	<p>5 L double-wall vessel, complete with 2 spargers CC and accessories without sensors (BBI-44439051) 5 L double-wall vessel, complete with accessories CC without sensors (BBI-44439050) 5 L vessel SW complete with standard accessories CC without sensors and heating jacket (BBI-44437050)</p>
<p>Description:</p>	



Alle / Verkaufsartikel / Accessories / Culture vessels / Equipped glass vessels

10 L double-wall vessel, complete with accessories MO without sensors



bbi Scancode	BBI-44438100
Manufacturer	bbi-biotech GmbH
Material Certificate	3.1, Rauigkeit, FDA
Country of Origin	DE 
Weight	37.56 kg
Material	Stainless steel 316L EPDM black borosilicate glass div.

Components

1x 10 L stainless steel stand [BBI-44430041] 1x 10 L lid [BBI-44430042] 1x 10 L jacketed glass vessel [BBI-44430044] 1x 10 L stirrer shaft, 16 mm [BBI-43230044] 1x powergrip coupling for 10 mm- stirrer shaft [BBI-44430402] 3x 10 L Rushton impeller [BBI-43230326] 1x 5-10 L exhaust cooler M 26 x 1 [BBI-43930007] 1x 4-fold addition port, M 26 x 1 [BBI-43630202] 1x blind plug for 19 mm ports M 26 x 1 [BBI-444130201] 5x blind plug Pg 13.5 [BBI-44130206] 4x blind plug M 10 x 1 [BBI-44130207] 1x 10 L baffle [BBI-43230034] 1x 10 L Pt100 casing [BBI-43430006] 1x Pt100 temperature sensor, 1 m [BBI-43430020] 1x 10 L harvest pipe fixed, Di = 4 mm, M 10 x 1 [BBI-43630014] 2x adapter for 6 mm level probes or dip tubes for harvesting in 11 mm ports [BBI-44630103] 1x antifoam or level probe L=100 mm [BBI-44630003] 1x cable for antifoam or level probe [BBI-44630010] 1x 10 L ring sparger, downwards-facing holes with 0.5 mm [BBI-43530092] 1x inoculation port with septa for 11 mm port [BBI-43630200] 1x universal adapter 6-4 [BBI-43930003] 1x 10 L harvest pipe flex, Di = 4 mm, without adapter [BBI-43630039] 1x equipotential bonding cable [BBI-44640980] 1x hose connection set vessel GL 18 [BBI-44430111] 1x consumable starter set autoclavables [BBI-45110100]



To the Shop:



Consumables

- Support for glass vessel (BBI-44430203)
- Lid screw (BBI-44430052)
- Grounding screw (for lid) (BBI-44430053)
- Wear parts for stirrer shafts up to 10 L (BBI-60000205)
- Replacement-connection-kit exhaust cooler (BBI-43930201)
- Silicone tube 3.2 x 1.6 mm (package with 5 m) (BBI-44130605)
- Innovaprene tube (ID x WT: 0.5 mm x 1.0 mm) (package of 5 m) (BBI-44130613)
- Sterile filter 30 mm 0.2 µm (package of 10 pieces) (BBI-44130510)
- Silicone tube 1.6 x 1.6 mm (package with 5 m) (BBI-44130604)
- Silicone tube 2.0 x 1.0 mm (package with 5 m) (BBI-44130612)
- Sterile filter gas 50 mm (BBI-44130511)
- Membrane/septa for inoculation port or manual bypass sampler (package of 10 pieces) (BBI-43830001)
- Stainless steel fitting grease, 5 ml (BBI-44130902)
- Clamping cone (Package of 5 pieces) (BBI-44130017)
- Flat seal with hole for 12 mm ports (package of 5 pieces) (BBI-44130214)
- Flat seal for 12 mm ports (Package of 5 pieces) (BBI-44130210)
- Gasket TC25 for hose connector exhaust cooler (package of 5 pieces) (BBI-45100302)
- O-ring for items to install in 11 mm ports (package of 10 pieces) (BBI-45100011)
- O-ring for items to install in M 26 x 1 ports (package of 10 pieces) (BBI-45100015)
- O-ring for adapter (package of 5 pieces) (BBI-45100025)
- Silicone grease, 5 ml (BBI-44130901)

Description:



Alle / Verkaufsartikel / Accessories / Culture vessels / Equipped glass vessels

0.5 L double-wall vessel, complete with accessories CC without sensors



bbi Scancode	BBI-44439005
Manufacturer	bbi-biotech GmbH
Material Certificate	3.1, Rauigkeit, FDA
Country of Origin	DE 
Material	Stainless steel 316L EPDM black borosilicate glass div.

Components

1x 0.5 L stainless steel stand [BBI-44430001] 1x 0.5 L lid [BBI-44430002] 1x 0.5 L jacketed glass vessel [BBI-44430004] 1x 0.5 L stirrer shaft, 8 mm [BBI-43230042] 1x powergrip coupling for 10 mm- stirrer shaft [BBI-44430402] 2x 0.5 L 3-bladed-segment impeller [BBI-43230302] 1x blind plug for 19 mm ports M 26 x 1 [BBI-44130201] 1x 3-fach Zugabestutzen 4 mm, PG 13,5 [BBI-43630252] 1x 0.5-1 L exhaust cooler Pg 13,5 [BBI-43930009] 1x blind plug Pg 13.5 [BBI-44130206] 1x inoculation port with septa for 11 mm port [BBI-43630200] 1x universal adapter 6-4 [BBI-43930003] 1x 0.5 L harvest pipe fixed, Di = 4 mm, M 10 x 1 [BBI-43630023] 1x blind plug M 10 x 1 [BBI-44130207] 1x 0.5 L Pt100 casing [BBI-43430007] 1x Pt100 temperature sensor, 1 m [BBI-43430020] 1x 0.5 L Microsparger without frit [BBI-43530200] 1x Frit M5, 20µm [BBI-43530064] 2x adapter for 6 mm level probes or dip tubes for harvesting in 11 mm ports [BBI-44630103] 1x antifoam or level probe L=100 mm [BBI-44630003] 1x cable for antifoam or level probe [BBI-44630010] 1x 0.5 L harvest pipe flex, Di = 4 mm, without adapter [BBI-43630035] 1x equipotential bonding cable [BBI-44640980] 1x hose connection set vessel GL 14 [BBI-44430110] 1x consumable starter set autoclavables [BBI-45110100]



To the Shop:



<p>Consumables</p>	<p>Support for glass vessel (BBI-44430203) Lid screw (BBI-44430052) Grounding screw (for lid) (BBI-44430053) Wear parts for stirrer shafts up to 10 L (BBI-60000205) Replacement-connection-kit exhaust cooler (BBI-43930201) Silicone tube 3.2 x 1.6 mm (package with 5 m) (BBI-44130605) Innovaprene tube (ID x WT: 0.5 mm x 1.0 mm) (package of 5 m) (BBI-44130613) Sterile filter 30 mm 0.2 µm (package of 10 pieces) (BBI-44130510) Silicone tube 1.6 x 1.6 mm (package with 5 m) (BBI-44130604) Silicone tube 2.0 x 1.0 mm (package with 5 m) (BBI-44130612) Sterile filter gas 50 mm (BBI-44130511) Membrane/septa for inoculation port or manual bypass sampler (package of 10 pieces) (BBI-43830001) Stainless steel fitting grease, 5 ml (BBI-44130902) Clamping cone (Package of 5 pieces) (BBI-44130017) Flat seal with hole for 12 mm ports (package of 5 pieces) (BBI-44130214) Flat seal for 12 mm ports (Package of 5 pieces) (BBI-44130210) Gasket TC25 for hose connector exhaust cooler (package of 5 pieces) (BBI-45100302) O-ring for items to install in 11 mm ports (package of 10 pieces) (BBI-45100011) O-ring for items to install in M 26 x 1 ports (package of 10 pieces) (BBI-45100015) O-ring for adapter (package of 5 pieces) (BBI-45100025) Silicone grease, 5 ml (BBI-44130901)</p>
<p>Related Products</p>	<p>0.5 L 3-bladed-segment impeller (BBI-43230302) 0.5 L Microsparger without frit (BBI-43530200) 0.5 L double-wall vessel, complete with accessories MO without sensors (BBI-44438005)</p>
<p>Description:</p>	



Alle / Verkaufsartikel / Accessories / Culture vessels / Equipped glass vessels

1 L double-wall vessel, complete with accessories CC without sensors



bbi Scancode	BBI-44439010
Manufacturer	bbi-biotech GmbH
Material Certificate	3.1, Rauigkeit, FDA
Country of Origin	DE 
Material	Stainless steel 316L EPDM black borosilicate glass div.

Components

1x 1 L stainless steel stand [BBI-44430011] 1x 1 L lid [BBI-44430012] 1x 1 L jacketed glass vessel [BBI-44430014] 1x 1 L stirrer shaft, 10 mm [BBI-43230040] 1x powergrip coupling for 10 mm- stirrer shaft [BBI-44430402] 2x 1 L 3-bladed-segment impeller [BBI-43230303] 1x 4-fold addition port, M 26 x 1 [BBI-43630202] 1x 0.5-1 L exhaust cooler, Pg 13,5 [BBI-43930009] 3x blind plug Pg 13,5 [BBI-44130206] 1x 1 L harvest pipe fixed, Di = 4 mm, M 10 x 1 [BBI-43630013] 2x adapter for 6 mm level probes or dip tubes for harvesting in 11 mm ports [BBI-44630103] 1x 1 L harvest pipe flex, Di = 4 mm, without adapter [BBI-43630036] 1x blind plug M 10 x 1 [BBI-44130207] 1x antifoam or level probe L=100 mm [BBI-44630003] 1x cable for antifoam or level probe [BBI-44630010] 1x universal adapter 6-4 [BBI-43930003] 1x 1 L Pt100 casing [BBI-43430021] 1x Pt100 temperature sensor, 1 m [BBI-43430020] 1x inoculation port with septa for 11 mm port [BBI-43630200] 1x 1 L microsparger without frit [BBI-43530201] 1x Frit M5, 20 µm [BBI-43530064] 1x equipotential bonding cable [BBI-44640980] 1x hose connection set vessel GL 14 [BBI-44430110] 1x consumable starter set autoclavables [BBI-45110100]



To the Shop:



Consumables	<p>Support for glass vessel (BBI-44430203)</p> <p>Lid screw (BBI-44430052)</p> <p>Grounding screw (for lid) (BBI-44430053)</p> <p>Wear parts for stirrer shafts up to 10 L (BBI-60000205)</p> <p>Replacement-connection-kit exhaust cooler (BBI-43930201)</p> <p>Silicone tube 3.2 x 1.6 mm (package with 5 m) (BBI-44130605)</p> <p>Innovaprene tube (ID x WT: 0.5 mm x 1.0 mm) (package of 5 m) (BBI-44130613)</p> <p>Sterile filter 30 mm 0.2 µm (package of 10 pieces) (BBI-44130510)</p> <p>Silicone tube 1.6 x 1.6 mm (package with 5 m) (BBI-44130604)</p> <p>Silicone tube 2.0 x 1.0 mm (package with 5 m) (BBI-44130612)</p> <p>Sterile filter gas 50 mm (BBI-44130511)</p> <p>Membrane/septa for inoculation port or manual bypass sampler (package of 10 pieces) (BBI-43830001)</p> <p>Stainless steel fitting grease, 5 ml (BBI-44130902)</p> <p>Clamping cone (Package of 5 pieces) (BBI-44130017)</p> <p>Flat seal with hole for 12 mm ports (package of 5 pieces) (BBI-44130214)</p> <p>Flat seal for 12 mm ports (Package of 5 pieces) (BBI-44130210)</p> <p>Gasket TC25 for hose connector exhaust cooler (package of 5 pieces) (BBI-45100302)</p> <p>O-ring for items to install in 11 mm ports (package of 10 pieces) (BBI-45100011)</p> <p>O-ring for items to install in M 26 x 1 ports (package of 10 pieces) (BBI-45100015)</p> <p>O-ring for adapter (package of 5 pieces) (BBI-45100025)</p> <p>Silicone grease, 5 ml (BBI-44130901)</p>
Related Products	<p>1 L double-wall vessel, complete with accessories MO without sensors (BBI-44438010)</p> <p>1 L single-walled glass vessel (BBI-44430301)</p> <p>1 L vessel DW complete with 2 spargers CC without sensors (BBI-44439011)</p>
Description:	



Alle / Verkaufsartikel / Accessories / Culture vessels / Equipped glass vessels

1 L vessel DW complete with 2 spargers CC without sensors



bbi Scancode	BBI-44439011
Manufacturer	bbi-biotech GmbH
Material Certificate	3.1, Rauigkeit, FDA
Material	Stainless steel 316L EPDM black borosilicate glass div.

Components

1x 1 L stainless steel stand [BBI-44430011] 1x 1 L lid [BBI-44430012] 1x 1 L jacketed glass vessel [BBI-44430014] 1x 1 L stirrer shaft, 10 mm [BBI-43230040] 1x powergrip coupling for 10 mm- stirrer shaft [BBI-44430402] 2x 1 L 3-bladed-segment impeller [BBI-43230303] 1x 4-fold addition port, M 26 x 1 [BBI-43630202] 1x 0.5-1 L exhaust cooler, Pg 13,5 [BBI-43930009] 3x blind plug Pg 13,5 [BBI-44130206] 1x 1 L harvest pipe fixed, Di = 4 mm, M 10 x 1 [BBI-43630013] 2x adapter for 6 mm level probes or dip tubes for harvesting in 11 mm ports [BBI-44630103] 1x 1 L harvest pipe flex, Di = 4 mm, without adapter [BBI-43630036] 1x antifoam or level probe L=100 mm [BBI-44630003] 1x cable for antifoam or level probe [BBI-44630010] 1x universal adapter 6-4 [BBI-43930003] 1x 1 L Pt100 casing [BBI-43430021] 1x Pt100 temperature sensor, 1 m [BBI-43430020] 1x inoculation port with septa for 11 mm port [BBI-43630200] 1x 1 L ring sparger, downwards-facing holes with 0.5 mm [BBI-43530088] 1x 1 L microsparger without frit [BBI-43530201] 1x Frit M5, 20 µm [BBI-43530064] 1x equipotential bonding cable [BBI-44640980] 1x hose connection set vessel GL 14 [BBI-44430110] 1x consumable starter set autoclavables [BBI-45110100]

Related Products

1 L double-wall vessel, complete with accessories CC without sensors (BBI-44439010)
 1 L double-wall vessel, complete with accessories MO without sensors (BBI-44438010)
 1 L single-walled glass vessel (BBI-44430301)

Description:



To the Shop:



Alle / Verkaufsartikel / Accessories / Culture vessels / Equipped glass vessels

2 L double-wall vessel, complete with accessories CC without sensors



bbi Scancode	BBI-44439020
Manufacturer	bbi-biotech GmbH
Material Certificate	3.1, Rauigkeit, FDA
Country of Origin	DE 
Weight	14.28 kg
Material	Stainless steel 316L EPDM black borosilicate glass div.

Components

1x 2 L stainless steel stand [BBI-44430021] 1x 2 L lid [BBI-44430022] 1x 2 L jacketed glass vessel [BBI-44430024] 1x 2 L stirrer shaft, 10 mm [BBI-43230041] 1x powergrip coupling for 10 mm- stirrer shaft [BBI-44430402] 2x 2 L 3-bladed-segment impeller [BBI-43230304] 1x 2 L exhaust cooler M 26 x 1 [BBI-43930005] 1x 4-fold addition port, M 26 x 1 [BBI-43630202] 4x blind plug Pg 13.5 [BBI-44130206] 5x blind plug M 10 x 1 [BBI-44130207] 1x 2 L harvest pipe fixed, Di = 4 mm, M 10 x 1 [BBI-43630012] 1x inoculation port with septa for 11 mm port [BBI-43630200] 1x universal adapter 6-4 [BBI-43930003] 1x 2 L Pt100 casing [BBI-43430004] 1x Pt100 temperature sensor, 1 m [BBI-43430020] 2x adapter for 6 mm level probes or dip tubes for harvesting in 11 mm ports [BBI-44630103] 1x antifoam or level probe L=100 mm [BBI-44630003] 1x cable for antifoam or level probe [BBI-44630010] 1x 2 L microsparger without frit [BBI-43530202] 1x frit, G 1/8, 20 µm [BBI-43530050] 1x 2 L harvest pipe flex, Di = 4 mm, without adapter [BBI-43630037] 1x equipotential bonding cable [BBI-44640980] 1x hose connection set vessel GL 14 [BBI-44430110] 1x consumable starter set autoclavables [BBI-45110100]



To the Shop:



<p>Consumables</p>	<p>Support for glass vessel (BBI-44430203) Lid screw (BBI-44430052) Grounding screw (for lid) (BBI-44430053) Wear parts for stirrer shafts up to 10 L (BBI-60000205) Replacement-connection-kit exhaust cooler (BBI-43930201) Silicone tube 3.2 x 1.6 mm (package with 5 m) (BBI-44130605) Innovaprene tube (ID x WT: 0.5 mm x 1.0 mm) (package of 5 m) (BBI-44130613) Sterile filter 30 mm 0.2 µm (package of 10 pieces) (BBI-44130510) Silicone tube 1.6 x 1.6 mm (package with 5 m) (BBI-44130604) Silicone tube 2.0 x 1.0 mm (package with 5 m) (BBI-44130612) Sterile filter gas 50 mm (BBI-44130511) Membrane/septa for inoculation port or manual bypass sampler (package of 10 pieces) (BBI-43830001) Stainless steel fitting grease, 5 ml (BBI-44130902) Clamping cone (Package of 5 pieces) (BBI-44130017) Flat seal with hole for 12 mm ports (package of 5 pieces) (BBI-44130214) Flat seal for 12 mm ports (Package of 5 pieces) (BBI-44130210) Gasket TC25 for hose connector exhaust cooler (package of 5 pieces) (BBI-45100302) O-ring for items to install in 11 mm ports (package of 10 pieces) (BBI-45100011) O-ring for items to install in M 26 x 1 ports (package of 10 pieces) (BBI-45100015) O-ring for adapter (package of 5 pieces) (BBI-45100025) Silicone grease, 5 ml (BBI-44130901)</p>
<p>Related Products</p>	<p>2 L double-wall vessel, complete with accessories MO without sensors (BBI-44438020) 2 L single-wall vessel, complete with accessories CC without sensors (BBI-44439022) 2 L vessel DW complete with 2 spargers CC and standard accessories without sensors (BBI-44439021)</p>
<p>Description:</p>	



Alle / Verkaufsartikel / Accessories / Culture vessels / Equipped glass vessels

2 L vessel DW complete with 2 spargers CC and standard accessories without sensors



bbi Scancode	BBI-44439021
Manufacturer	bbi-biotech GmbH
Material Certificate	3.1, Rauigkeit, FDA
Country of Origin	DE 
Material	Stainless steel 316L EPDM black borosilicate glass div.

Components

1x 2 L stainless steel stand [BBI-44430021] 1x 2 L lid [BBI-44430022] 1x 2 L jacketed glass vessel [BBI-44430024] 1x 2 L stirrer shaft, 10 mm [BBI-43230041] 1x powergrip coupling for 10 mm- stirrer shaft [BBI-44430402] 2x 2 L 3-bladed-segment impeller [BBI-43230304] 1x 2 L exhaust cooler M 26 x 1 [BBI-43930005] 1x 4-fold addition port, M 26 x 1 [BBI-43630202] 4x blind plug Pg 13,5 [BBI-44130206] 4x blind plug M 10 x 1 [BBI-44130207] 1x 2 L harvest pipe fixed, Di = 4 mm, M 10 x 1 [BBI-43630012] 1x universal adapter 6-4 [BBI-43930003] 1x 2 L Pt100 casing [BBI-43430004] 1x Pt100 temperature sensor, 1 m [BBI-43430020] 1x antifoam or level probe L=100 mm [BBI-44630003] 1x cable for antifoam or level probe [BBI-44630010] 1x inoculation port with septum for 11 mm ports [BBI-43630200] 1x 2 L ring sparger, downwards-facing holes with 0,5 mm [BBI-43530089] 1x 2 L microsparger without frit [BBI-43530202] 1x frit, G 1/8, 20 µm [BBI-43530050] 2x adapter for 6 mm level probes or dip tubes for harvesting in 11 mm ports [BBI-44630103] 1x 2 L harvest pipe flex, Di = 4 mm, without adapter [BBI-43630037] 1x equipotential bonding cable [BBI-44640980] 1x hose connection set vessel GL 14 [BBI-44430110] 1x consumable starter set autoclavables [BBI-45110100]

Related Products

2 L double-wall vessel, complete with accessories CC without sensors (BBI-44439020)
 2 L double-wall vessel, complete with accessories MO without sensors (BBI-44438020)
 2 L vessel SW complete with 2 spargers CC without sensors and heating jacket (BBI-44437021)

Description:



To the Shop:



Alle / Verkaufsartikel / Accessories / Culture vessels / Equipped glass vessels

2 L single-wall vessel, complete with accessories CC without sensors



bbi Scancode	BBI-44439022
Manufacturer	bbi-biotech GmbH
Material Certificate	3.1, Raugkeit, FDA
Country of Origin	DE 
Material	Stainless steel 316L EPDM black borosilicate glass div.

Components

1x 2 L stainless steel stand [BBI-44430021] 1x 2 L lid [BBI-44430022] 1x 2 L single-walled glass vessel [BBI-44430302] 1x 2 L stirrer shaft, 10 mm [BBI-43230041] 1x powergrip coupling for 10 mm- stirrer shaft [BBI-44430402] 2x 2 L 3-bladed-segment impeller [BBI-43230304] 1x 2 L exhaust cooler M 26 x 1 [BBI-43930005] 1x 4-fold addition port, M 26 x 1 [BBI-43630202] 4x blind plug Pg 13.5 [BBI-44130206] 5x blind plug M 10 x 1 [BBI-44130207] 1x inoculation port with septum for 11 mm ports [BBI-43630200] 1x 2 L harvest pipe fixed, Di = 4 mm, M 10 x 1 [BBI-43630012] 1x universal adapter 6-4 [BBI-43930003] 1x 2 L Pt100 casing [BBI-43430004] 2x adapter for 6 mm level probes or dip tubes for harvesting in 11 mm ports [BBI-44630103] 1x antifoam or level probe L=100 mm [BBI-44630003] 1x cable for antifoam or level probe [BBI-44630010] 1x Pt100 temperature sensor, 1 m [BBI-43430020] 1x 2 L microsparger without frit [BBI-43530202] 1x frit, G 1/8, 20 µm [BBI-43530050] 1x 2 L harvest pipe flex, Di = 4 mm, without adapter [BBI-43630037] 1x equipotential bonding cable [BBI-44640980] 1x hose connection set vessel GL 14 [BBI-44430110] 1x consumable starter set autoclavables [BBI-45110100]

Related Products

2 L double-wall vessel, complete with accessories CC without sensors (BBI-44439020)
 2 L single-wall vessel, complete with accessories CC without sensors and heating jacket (BBI-44437020)
 2 L vessel SW complete with 2 spargers CC without sensors and heating jacket (BBI-44437021)

Description:



To the Shop:



Alle / Verkaufsartikel / Accessories / Culture vessels / Equipped glass vessels

5 L double-wall vessel, complete with accessories CC without sensors



bbi Scancode	BBI-44439050
Manufacturer	bbi-biotech GmbH
Material Certificate	3.1, Rauigkeit, FDA
Country of Origin	DE 
Weight	22.75 kg
Material	Stainless steel 316L EPDM black borosilicate glass div.

Components

1x 5 L stainless steel stand [BBI-44430031] 1x 5 L lid [BBI-44430032] 1x 5 L jacketed glass vessel [BBI-44430034] 1x 5 L stirrer shaft, 10 mm [BBI-43230046] 1x powergrip coupling for 10 mm- stirrer shaft [BBI-44430402] 3x 5 L 3-bladed-segment impeller [BBI-43230305] 1x 4-fold addition port, M 26 x 1 [BBI-43630202] 1x 5-10 L exhaust cooler M 26 x 1 [BBI-43930007] 1x blind plug for 19 mm ports M 26 x 1 [BBI-44130201] 4x blind plug Pg 13.5 [BBI-44130206] 1x universal adapter 6-4 [BBI-43930003] 1x 5 L Microsparger without frit [BBI-43530203] 1x Frit, G 1/8, 20 µm [BBI-43530050] 5x blind plug M 10 x 1 [BBI-44130207] 1x 5 L harvest pipe fixed, Di = 4 mm, M 10 x 1 [BBI-43630005] 2x adapter for 6 mm level probes or dip tubes for harvesting in 11 mm ports [BBI-44630103] 1x 5 L harvest pipe flex, Di = 4 mm, without adapter [BBI-43630038] 1x inoculation port with septa for 11 mm port [BBI-43630200] 1x antifoam or level probe L=100 mm [BBI-44630003] 1x cable for antifoam or level probe [BBI-44630010] 1x 5 L Pt100 casing [BBI-43430005] 1x Pt100 temperature sensor, 1 m [BBI-43430020] 1x equipotential bonding cable [BBI-44640980] 1x hose connection set vessel GL 18 [BBI-44430111] 1x consumable starter set autoclavables [BBI-45110100]



To the Shop:



<p>Consumables</p>	<p>Support for glass vessel (BBI-44430203) Lid screw (BBI-44430052) Grounding screw (for lid) (BBI-44430053) Wear parts for stirrer shafts up to 10 L (BBI-60000205) Replacement-connection-kit exhaust cooler (BBI-43930201) Silicone tube 3.2 x 1.6 mm (package with 5 m) (BBI-44130605) Innovaprene tube (ID x WT: 0.5 mm x 1.0 mm) (package of 5 m) (BBI-44130613) Sterile filter 30 mm 0.2 µm (package of 10 pieces) (BBI-44130510) Silicone tube 1.6 x 1.6 mm (package with 5 m) (BBI-44130604) Silicone tube 2.0 x 1.0 mm (package with 5 m) (BBI-44130612) Sterile filter gas 50 mm (BBI-44130511) Membrane/septa for inoculation port or manual bypass sampler (package of 10 pieces) (BBI-43830001) Stainless steel fitting grease, 5 ml (BBI-44130902) Clamping cone (Package of 5 pieces) (BBI-44130017) Flat seal with hole for 12 mm ports (package of 5 pieces) (BBI-44130214) Flat seal for 12 mm ports (Package of 5 pieces) (BBI-44130210) Gasket TC25 for hose connector exhaust cooler (package of 5 pieces) (BBI-45100302) O-ring for items to install in 11 mm ports (package of 10 pieces) (BBI-45100011) O-ring for items to install in M 26 x 1 ports (package of 10 pieces) (BBI-45100015) O-ring for adapter (package of 5 pieces) (BBI-45100025) Silicone grease, 5 ml (BBI-44130901)</p>
<p>Related Products</p>	<p>5 L double-wall vessel, complete with 2 spargers CC and accessories without sensors (BBI-44439051) 5 L double-wall vessel, complete with accessories MO without sensors (BBI-44438050) 5 L vessel SW complete with standard accessories CC without sensors and heating jacket (BBI-44437050)</p>
<p>Description:</p>	



Alle / Verkaufsartikel / Accessories / Culture vessels / Equipped glass vessels

5 L double-wall vessel, complete with 2 spargers CC and accessories without sensors



bbi Scancode	BBI-44439051
Manufacturer	bbi-biotech GmbH
Material Certificate	3.1, Rauigkeit, FDA
Country of Origin	DE 
Material	Stainless steel 316L EPDM black borosilicate glass div.

Components	<p>1x 5 L stainless steel stand [BBI-44430031] 1x 5 L lid [BBI-44430032] 1x 5 L jacketed glass vessel [BBI-44430034] 1x 5 L stirrer shaft, 10 mm [BBI-43230046] 1x powergrip coupling for 10 mm- stirrer shaft [BBI-44430402] 3x 5 L 3-bladed-segment impeller [BBI-43230305] 1x 4-fold addition port, M 26 x 1 [BBI-43630202] 1x 5-10 L exhaust cooler M 26 x 1 [BBI-43930007] 1x blind plug for 19 mm ports M 26 x 1 [BBI-44130201] 4x blind plug Pg 13.5 [BBI-44130206] 1x universal adapter 6-4 [BBI-43930003] 1x 5 L ring sparger, downwards-facing holes with 0.5 mm [BBI-43530090] 1x 5 L Microsparger without frit [BBI-43530203] 1x Frit, G 1/8, 20 µm [BBI-43530050] 4x blind plug M 10 x 1 [BBI-44130207] 1x 5 L harvest pipe fixed, Di = 4 mm, M 10 x 1 [BBI-43630005] 2x adapter for 6 mm level probes or dip tubes for harvesting in 11 mm ports [BBI-44630103] 1x 5 L harvest pipe flex, Di = 4 mm, without adapter [BBI-43630038] 1x inoculation port with septa for 11 mm port [BBI-43630200] 1x antifoam or level probe L=100 mm [BBI-44630003] 1x cable for antifoam or level probe [BBI-44630010] 1x 5 L Pt100 casing [BBI-43430005] 1x Pt100 temperature sensor, 1 m [BBI-43430020] 1x equipotential bonding cable [BBI-44640980] 1x hose connection set vessel GL 18 [BBI-44430111] 1x consumable starter set autoclavables [BBI-45110100]</p>
Related Products	<p>5 L double-wall vessel, complete with accessories CC without sensors (BBI-44439050) 5 L double-wall vessel, complete with accessories MO without sensors (BBI-44438050) 5 L vessel SW complete with 2 spargers CC without sensors and heating jacket (BBI-44437051)</p>
Description:	



Alle / Verkaufsartikel / Accessories / Culture vessels / Equipped glass vessels

10 L double-wall vessel, complete with accessories CC without sensors



bbi Scancode	BBI-44439100
Manufacturer	bbi-biotech GmbH
Material Certificate	3.1, Rauigkeit, FDA
Country of Origin	DE 
Weight	37.56 kg
Material	Stainless steel 316L EPDM black borosilicate glass div.

Components

1x 10 L stainless steel stand [BBI-44430041] 1x 10 L lid [BBI-44430042] 1x 10 L jacketed glass vessel [BBI-44430044] 1x 10 L stirrer shaft, 16 mm [BBI-43230044] 1x powergrip coupling for 10 mm- stirrer shaft [BBI-44430402] 3x 10 L 3-bladed-segment impeller [BBI-43230306] 1x 5-10 L exhaust cooler M 26 x 1 [BBI-43930007] 1x 4-fold addition port, M 26 x 1 [BBI-43630202] 1x blind plug for 19 mm ports M 26 x 1 [BBI-44130201] 5x blind plug Pg 13.5 [BBI-44130206] 6x blind plug M 10 x 1 [BBI-44130207] 1x 10 L Pt100 casing [BBI-43430006] 1x Pt100 temperature sensor, 1 m [BBI-43430020] 1x 10 L harvest pipe fixed, Di = 4 mm, M 10 x 1 [BBI-43630014] 2x adapter for 6 mm level probes or dip tubes for harvesting in 11 mm ports [BBI-44630103] 1x antifoam or level probe L=100 mm [BBI-44630003] 1x cable for antifoam or level probe [BBI-44630010] 1x 10 L Microsparger without frit [BBI-43530204] 1x Frit, G 1/8, 20 µm [BBI-43530050] 1x inoculation port with septa for 11 mm port [BBI-43630200] 1x universal adapter 6-4 [BBI-43930003] 1x 10 L harvest pipe flex, Di = 4 mm, without adapter [BBI-43630039] 1x equipotential bonding cable [BBI-44640980] 1x hose connection set vessel GL 18 [BBI-44430111] 1x consumable starter set autoclavables [BBI-45110100]



To the Shop:



Consumables

- Support for glass vessel (BBI-44430203)
- Lid screw (BBI-44430052)
- Grounding screw (for lid) (BBI-44430053)
- Wear parts for stirrer shafts up to 10 L (BBI-60000205)
- Replacement-connection-kit exhaust cooler (BBI-43930201)
- Silicone tube 3.2 x 1.6 mm (package with 5 m) (BBI-44130605)
- Innovaprene tube (ID x WT: 0.5 mm x 1.0 mm) (package of 5 m) (BBI-44130613)
- Sterile filter 30 mm 0.2 µm (package of 10 pieces) (BBI-44130510)
- Silicone tube 1.6 x 1.6 mm (package with 5 m) (BBI-44130604)
- Silicone tube 2.0 x 1.0 mm (package with 5 m) (BBI-44130612)
- Sterile filter gas 50 mm (BBI-44130511)
- Membrane/septa for inoculation port or manual bypass sampler (package of 10 pieces) (BBI-43830001)
- Stainless steel fitting grease, 5 ml (BBI-44130902)
- Clamping cone (Package of 5 pieces) (BBI-44130017)
- Flat seal with hole for 12 mm ports (package of 5 pieces) (BBI-44130214)
- Flat seal for 12 mm ports (Package of 5 pieces) (BBI-44130210)
- Gasket TC25 for hose connector exhaust cooler (package of 5 pieces) (BBI-45100302)
- O-ring for items to install in 11 mm ports (package of 10 pieces) (BBI-45100011)
- O-ring for items to install in M 26 x 1 ports (package of 10 pieces) (BBI-45100015)
- O-ring for adapter (package of 5 pieces) (BBI-45100025)
- Silicone grease, 5 ml (BBI-44130901)

Description:



Alle / Verkaufsartikel / Accessories / Culture vessels / Equipped glass vessels

10 L vessel DW complete with 2 spargers CC without sensors



bbi Scancode	BBI-44439101
Manufacturer	bbi-biotech GmbH
Material Certificate	3.1, Rauigkeit, FDA
Material	Stainless steel 316L EPDM black borosilicate glass div.

Components

1x 10 L stainless steel stand [BBI-44430041] 1x 10 L lid [BBI-44430042] 1x 10 L jacketed glass vessel [BBI-44430044] 1x 10 L stirrer shaft, 16 mm [BBI-43230044] 1x powergrip coupling for 10 mm- stirrer shaft [BBI-44430402] 3x 10 L 3-bladed-segment impeller [BBI-43230306] 1x 5-10 L exhaust cooler M 26 x 1 [BBI-43930007] 1x 4-fold addition port, M 26 x 1 [BBI-43630202] 1x blind plug for 19 mm ports M 26 x 1 [BBI-44130201] 5x blind plug Pg 13.5 [BBI-44130206] 5x blind plug M 10 x 1 [BBI-44130207] 1x 10 L Pt100 casing [BBI-43430006] 1x Pt100 temperature sensor, 1 m [BBI-43430020] 1x 10 L harvest pipe fixed, Di = 4 mm, M 10 x 1 [BBI-43630014] 2x adapter for 6 mm level probes or dip tubes for harvesting in 11 mm ports [BBI-44630103] 1x antifoam or level probe L=100 mm [BBI-44630003] 1x cable for antifoam or level probe [BBI-44630010] 1x 10 L ring sparger, downwards-facing holes with 0.5 mm [BBI-43530092] 1x 10 L Microsparger without frit [BBI-43530204] 1x Frit, G 1/8, 20 µm [BBI-43530050] 1x inoculation port with septa for 11 mm port [BBI-43630200] 1x universal adapter 6-4 [BBI-43930003] 1x 10 L harvest pipe flex, Di = 4 mm, without adapter [BBI-43630039] 1x equipotential bonding cable [BBI-44640980] 1x hose connection set vessel GL 18 [BBI-44430111] 1x consumable starter set autoclavables [BBI-45110100]

Description:



To the Shop:



Alle / Verkaufsartikel / Accessories / Culture vessels / Lids

0.5 L lid



bbi Scancode	BBI-44430002
Manufacturer	bbi-biotech GmbH
Internal Thread	M 38 x 1,5; M 26 x 1; Pg 13,5; M 8
Material Certificate	3.1, Rauigkeit, FDA
Country of Origin	DE 
HS-Code	73269098
Weight	2.36 kg
Material	Stainless steel 316L

Components	1x lid, 2x handles, 2x knurled head screw [BBI-44430052], 1x grounding screw [BBI-44430053], 1x O ring [BBI-45100020]
Consumables	Lid screw (BBI-44430052) Grounding screw (for lid) (BBI-44430053) 0.5 L o-ring (BBI-45100020)
Related Products	0.5 L jacketed glass vessel (BBI-44430004) 0.5 L single-walled glass vessel (BBI-44430300) 0.5 L stainless steel stand (BBI-44430001)

Description:

- Headplate for 0,5 L bioreactor vessels
- Headplate diameter: 173 mm
- Headplate height: 14 mm
- 1x M 38 x 1.5 port
- 1x M 26 x 1 19 mm port
- 3x Pg 13.5 12 mm port
- 8x 11 mm port
- Manufactured with stainless steel
- Headplate without accessories
- Fixated on rack with 3 knurled head screws M 8



To the Shop:



Alle / Verkaufsartikel / Accessories / Culture vessels / Lids

0.5 L lid with angled Pg 13.5 port for exhaust air cooler



bbi Scancode

BBI-44430006

Components	
Related Products	<ul style="list-style-type: none"> 0.5 L jacketed glass vessel (BBI-44430004) 0.5 L stainless steel stand (BBI-44430001) 0.5-1 L exhaust cooler, Pg 13.5 (BBI-43930009)
Description:	



To the Shop:



Alle / Verkaufsartikel / Accessories / Culture vessels / Lids

1 L lid



bbi Scancode	BBI-44430012
Manufacturer	bbi-biotech GmbH
Internal Thread	M 38 x 1,5; M 26 x 1; Pg 13,5; M 8
Material Certificate	3.1, Rauigkeit, FDA
Country of Origin	DE 
HS-Code	73269098
Weight	2.93 kg
Material	Stainless steel 316L

Components	1x lid, 2x handles, 2x knurled head screw [BBI-44430052], 1x grounding screw [BBI-44430053], 1x O ring [BBI-45100021]
Consumables	Lid screw (BBI-44430052) Grounding screw (for lid) (BBI-44430053) 1 L o-ring (BBI-45100021)
Related Products	1 L double-wall vessel, complete with accessories MO without sensors (BBI-44438010) 1 L jacketed glass vessel (BBI-44430014) 1 L stainless steel stand (BBI-44430011)

Description:

- Headplate for 1 L bioreactor vessels
- Headplate height: 14 mm
- 1x M 38 x 1.5 port
- 1x M 26 x 1 19 mm port
- 4x Pg 13.5 12 mm port
- 8x 11 mm port
- Manufactured with stainless steel
- Headplate without accessories
- Fixated on rack with 3 knurled head screws M 8



To the Shop:



Alle / Verkaufsartikel / Accessories / Culture vessels / Lids

2 L lid



bbi Scancode	BBI-44430022
Manufacturer	bbi-biotech GmbH
Internal Thread	M 38 x 1,5; M 26 x 1; Pg 13,5; M 8
Material Certificate	3.1, Rauigkeit, FDA
Country of Origin	DE 
HS-Code	73269098
Weight	3.46 kg
Material	Stainless steel 316L

Components	1x lid, 2x handles, 2x knurled head screw [BBI-44430052], 1x grounding screw [BBI-44430053], 1x O ring [BBI-45100022]
Related Products	2 L o-ring (BBI-45100022) 2 L stainless steel stand (BBI-44430021) Lid screw (BBI-44430052)

Description:

- Headplate for 2 L bioreactor vessels
- Headplate Diameter: 195 mm
- Headplate height: 14 mm
- 1x M 38 x 1,5 port
- 2x M 26 x 1 19 mm port
- 4x Pg 13.5 12 mm port
- 12x 11 mm port
- Manufactured with stainless steel
- Headplate without accessories
- Fixated on rack with 3 knurled head screws M 8



To the Shop:



Alle / Verkaufsartikel / Accessories / Culture vessels / Lids

2 L lid for stainless steel vessel



bbi Scancode	BBI-44430028
Country of Origin	DE 

Components	
Related Products	2 L jacketed stainless steel vessel (BBI-44430026) 5 L jacketed stainless steel vessel (BBI-44430027) 5 L lid for stainless steel vessel (BBI-44430037)
Description:	



To the Shop:



Alle / Verkaufsartikel / Accessories / Culture vessels / Lids

5 L lid



bbi Scancode	BBI-44430032
Manufacturer	bbi-biotech GmbH
Internal Thread	M 38 x 1,5; M 26 x 1; Pg 13,5; M 8
Material Certificate	3.1, Rauigkeit, FDA
Country of Origin	DE 
HS-Code	73269098
Weight	6.7 kg
Material	Stainless steel 316L

Components	1x lid, 2x handles, 4x knurled head screw [BBI-44430052], 1x grounding screw [BBI-44430053], 1x O ring [BBI-45100023]
Consumables	Lid screw (BBI-44430052) Grounding screw (for lid) (BBI-44430053) 5 L o-ring (BBI-45100023)
Related Products	0.5 L jacketed glass vessel (BBI-44430004) 5 L o-ring (BBI-45100023) 5 L stainless steel stand (BBI-44430031)

Description:

- Headplate for 5 L bioreactor vessels
- Headplate Diameter: 240 mm
- Headplate height: 14 mm
- 1x M 38 x 1.5 port
- 3x M 26 x 1 19 mm port
- 4x Pg 13.5 12 mm port
- 12x 11 mm port
- Manufactured with stainless steel
- Headplate without accessories
- Fixated on rack with 5 knurled head screws M 8



To the Shop:



Alle / Verkaufsartikel / Accessories / Culture vessels / Lids

5 L lid for stainless steel vessel



bbi Scancode	BBI-44430037
Manufacturer	bbi-biotech GmbH
Internal Thread	M 38 x 1,5; M 26 x 1; Pg 13,5; M 8
Material Certificate	3.1, Rauigkeit
Country of Origin	DE 
Material	Stainless steel 316L

Components	
Related Products	2 L lid for stainless steel vessel (BBI-44430028) 5 L double-wall stainless steel vessel, complete with accessories MO without sensors (BBI-44436050) 5 L jacketed glass vessel (BBI-44430034)
Description:	



To the Shop:



Alle / Verkaufsartikel / Accessories / Culture vessels / Lids

10 L lid



bbi Scancode	BBI-44430042
Manufacturer	bbi-biotech GmbH
Internal Thread	M 38 x 1,5; M 26 x 1; Pg 13,5; M 8
Material Certificate	3.1, Rauigkeit, FDA
Country of Origin	DE 
HS-Code	73269098
Material	Stainless steel 316L

Components	1x lid, 2x handles, 5x knurled head screw [BBI-44430052], 1x grounding screw [BBI-44430053], 1x O ring [BBI-45100024]
Consumables	10 L o-ring (BBI-45100024) Lid screw (BBI-44430052) Grounding screw (for lid) (BBI-44430053)

Description:

- Headplate for 10 L bioreactor vessels
- Headplate height: 14 mm
- 1x M 38 x 1.5 port
- 3x M 26 x 1 19 mm port
- 5x Pg 13.5 12 mm port
- 13x 11 mm port
- Manufactured with stainless steel
- Headplate without accessories
- Fixated on rack with 6 knurled head screws M 8



To the Shop:



Alle / Verkaufsartikel / Accessories / Culture vessels / Lids

Lid bubble column



bbi Scancode	BBI-44430072
Manufacturer	bbi-biotech GmbH
Internal Thread	Pg 13,5; 11 mm
Material Certificate	3.1, Rauigkeit
Country of Origin	DE 
HS-Code	73269098
Weight	0.6 kg
Material	Stainless steel 316L

Components	1x lid
Related Products	<ul style="list-style-type: none"> 0.5 L bubble column (BBI-44430070) 1 L bubble column (BBI-44430071) Clip for lid bubble column and 0.25 L vessel (BBI-44430073)

Description:

- Lid for bubble column [BBI-44430070] or [BBI-44430071]
- 4x Pg 13.5 12 mm port
- 5x 11 mm port
- Manufactured with stainless steel
- Headplate without accessories
- Fixated on vessel with clip [BBI-44430073]



To the Shop:



Alle / Verkaufsartikel / Accessories / Culture vessels / Lids

Clip for lid bubble column and 0.25 L vessel



bbi Scancode	BBI-44430073
Manufacturer	bbi-biotech GmbH
HS-Code	0

Components	1x clip
Related Products	0,25 L lid (BBI-44430352) 1 L bubble column (BBI-44430071) Lid bubble column (BBI-44430072)
Description: To install the lid [BBI-44430072] on a bubble column	



To the Shop:



Alle / Verkaufsartikel / Accessories / Culture vessels / Lids

Lid screw for 10 L glass vessels (set)



bbi Scancode	BBI-44430076
Manufacturer	bbi-biotech GmbH
External Thread	M 8
Country of Origin	DE 
Material	Stainless steel 316L

Components	5x lid screw; 1x grounding screw
Related Products	Lid screw (BBI-44430052) Lid screw for 0.5 - 2 L glass vessels (set) (BBI-44430074) Lid screw for 5 L glass vessels (set) (BBI-44430075)
Description: <ul style="list-style-type: none"> • Used for fixating headplates on bioreactors • Thread M 8 • Set of lid screws und grounding screw for 10 L vessels • Stainless steel 	



To the Shop:



Alle / Verkaufsartikel / Accessories / Culture vessels / Lids

0,25 L lid



bbi Scancode	BBI-44430352
Manufacturer	bbi-biotech GmbH
Internal Thread	M 26 x 1; Pg 13,5
Material Certificate	3.1, Rauigkeit, FDA
Material	Stainless steel 316L EPDM black

Components	1x lid, 1x o-ring, 1x clip
Related Products	0,25 L dip tube for harvesting, fix, ID = 4 mm (BBI-43630026) 0.25 L stirrer shaft, 6 mm (BBI-43230047) 0.5 L lid (BBI-44430002)
<p>Description:</p> <ul style="list-style-type: none"> • Lid for 0.25 L bioreactor vessels • Headplate height: 14 mm • 3x M 26 x 1 19 mm port • 4x Pg 13.5 12 mm port • 2x 11 mm port • Manufactured with stainless steel • Headplate without accessories • Fixated on rack with clip 	



Alle / Verkaufsartikel / Accessories / Culture vessels / Lid screws

Knurled Head Screw with dowel pin M8



bbi Scancode	BBI-44430050
Manufacturer	bbi-biotech GmbH
External Thread	M 8
Country of Origin	DE 
HS-Code	73269098
Material	Stainless steel 316L

Components	1x knurled head screw
Related Products	Grounding screw (for lid) (BBI-44430053) Knurled Head Screw with dowel pin M16 (BBI-44430051) Lid screw (BBI-44430052)
Description: <ul style="list-style-type: none"> • Used for fixating headplates on bioreactors • Used in in-situ sterilizable systems • With the help of the dowel pin the screws can be tightened better • Made of stainless steel 	



To the Shop:



Alle / Verkaufsartikel / Accessories / Culture vessels / Lid screws

Knurled Head Screw with dowel pin M16



bbi Scancode	BBI-44430051
Manufacturer	bbi-biotech GmbH
External Thread	M 16 x 1,5
Country of Origin	DE 
HS-Code	73269098
Material	Stainless steel 316L

Components	1x knurled head screw
Related Products	Grounding screw (for lid) (BBI-44430053) Knurled Head Screw with dowel pin M8 (BBI-44430050) Lid screw (BBI-44430052)
Description: <ul style="list-style-type: none"> • Used for fixating headplates on bioreactors • Used in in-situ sterilizable systems • With the help of the dowel pin the screws can be tightened better • Made of stainless steel 	



To the Shop:



Alle / Verkaufsartikel / Accessories / Culture vessels / Lid screws

Lid screw



bbi Scancode	BBI-44430052
Manufacturer	bbi-biotech GmbH
External Thread	M 8
Country of Origin	DE 
HS-Code	73269098
Material	Stainless steel 316L

Components	1x knurled head screw
Related Products	Lid screw for 0.5 - 2 L glass vessels (set) (BBI-44430074) Lid screw for 10 L glass vessels (set) (BBI-44430076) Lid screw for 5 L glass vessels (set) (BBI-44430075)
Description: <ul style="list-style-type: none"> • Used for fixating headplates on bioreactors • Thread M8 • Stainless steel 	



To the Shop:



Alle / Verkaufsartikel / Accessories / Culture vessels / Lid screws

Grounding screw (for lid)



bbi Scancode	BBI-44430053
Manufacturer	bbi-biotech GmbH
External Thread	M 8
Country of Origin	DE 
HS-Code	73269098
Weight	0.04 kg
Material	Stainless steel 316L

Components	1x knurled head screw
Related Products	Equipotential bonding cable (BBI-44640980) Equipotential bonding cable (for autoclavable stainless steel vessels) (BBI-44640982) Lid screw (BBI-44430052)
<p>Description:</p> <ul style="list-style-type: none"> • Used for fixating headplates on bioreactors • To ensure proper functioning of the level and anti-foam probes, a potential equalization between the controller and the vessel must be established. This is achieved through the equipotential cable, where one end is connected to the controller and the other end is secured in the grounding screw, utilizing the hole for proper attachment. • Thread M 8 	



Alle / Verkaufsartikel / Accessories / Culture vessels / Lid screws

Lid screw for 0.5 - 2 L glass vessels (set)



bbi Scancode	BBI-44430074
Manufacturer	bbi-biotech GmbH
External Thread	M 8
Country of Origin	DE 
Material	Stainless steel 316L

Components	2x lid screw; 1x grounding screw
Related Products	Lid screw (BBI-44430052) Lid screw for 10 L glass vessels (set) (BBI-44430076) Lid screw for 5 L glass vessels (set) (BBI-44430075)
Description: <ul style="list-style-type: none"> • Used for fixating headplates on bioreactors • Thread M 8 • Set of lid screws und grounding screw for 0.5 L-, 1 L- and 2 L-vessels • Stainless steel 	



To the Shop:



Alle / Verkaufsartikel / Accessories / Culture vessels / Lid screws

Lid screw for 5 L glass vessels (set)



bbi Scancode	BBI-44430075
Manufacturer	bbi-biotech GmbH
External Thread	M 8
Country of Origin	DE 
Material	Stainless steel 316L

Components	4x lid screw; 1x grounding screw
Related Products	Lid screw (BBI-44430052) Lid screw for 0.5 - 2 L glass vessels (set) (BBI-44430074) Lid screw for 10 L glass vessels (set) (BBI-44430076)
<p>Description:</p> <ul style="list-style-type: none"> • Used for fixating headplates on bioreactors • Thread M 8 • Set of lid screws und grounding screw for 5 L vessels • Stainless steel 	



Alle / Verkaufsartikel / Accessories / Culture vessels / Bottle holders

Bottle holder for 0.25 L bottles



bbi Scancode	BBI-44430060
Manufacturer	bbi-biotech GmbH
Country of Origin	DE 
HS-Code	73269098
Weight	0.49 kg
Material	Stainless steel 316L

Components	1x bottle holder
Related Products	<p>10 L bottle holder 3-way (for 0.25 L bottles) (BBI-44430066)</p> <p>5 L bottle holder 3-way (for 0.25 L bottles) (BBI-44430064)</p> <p>Bottle holder for 0.5 L bottles (BBI-44430061)</p>
<p>Description:</p> <ul style="list-style-type: none"> • For square media bottles 500 ml or round bottles 250 ml • To be mounted on bioreactor rack 	



Alle / Verkaufsartikel / Accessories / Culture vessels / Bottle holders

Bottle holder for 0.5 L bottles



bbi Scancode	BBI-44430061
Manufacturer	bbi-biotech GmbH
Country of Origin	DE 
HS-Code	73269098
Material	Stainless steel 316L

Components	1x bottle holder
Related Products	10 L bottle holder 3-way (for 0.5 L bottles) (BBI-44430067) 5 L bottle holder 3-way (for 0.5 L bottles) (BBI-44430065) Bottle holder for 0.25 L bottles (BBI-44430060)
Description: <ul style="list-style-type: none"> • For round media bottles 500 ml • To be mounted on bioreactor rack • Accessories for bioreactors • Bottle not included 	



To the Shop:



Alle / Verkaufsartikel / Accessories / Culture vessels / Bottle holders

2 L bottle holder 3-way (for 0.25 L bottles)



bbi Scancode	BBI-44430062
Manufacturer	bbi-biotech GmbH
Country of Origin	DE 
HS-Code	73269098
Material	Stainless steel 316L

Components	1x bottle holder
Related Products	2 L stainless steel stand (BBI-44430021) Bottle holder for 0.25 L bottles (BBI-44430060) Bottle holder for 0.5 L bottles (BBI-44430061)
Description: <ul style="list-style-type: none"> • For three media bottles 250 ml • To be mounted on 2 L bioreactor rack [BBI-44430021] • Accessories for bioreactors • Bottle not included 	



Alle / Verkaufsartikel / Accessories / Culture vessels / Bottle holders

2 L bottle holder 3-way (for 0.5 L bottles)



bbi Scancode	BBI-44430063
Manufacturer	bbi-biotech GmbH
Country of Origin	DE 
HS-Code	73269098
Material	Stainless steel 316L

Components	1x bottle holder
Related Products	<p>2 L bottle holder 3-way (for 0.25 L bottles) (BBI-44430062)</p> <p>Bottle holder for 0.25 L bottles (BBI-44430060)</p> <p>Bottle holder for 0.5 L bottles (BBI-44430061)</p>
<p>Description:</p> <ul style="list-style-type: none"> • For three media bottles 500 ml • To be mounted on 2 L bioreactor rack [BBI-44430021] • Accessories for bioreactors • Bottle not included 	



Alle / Verkaufsartikel / Accessories / Culture vessels / Bottle holders

5 L bottle holder 3-way (for 0.25 L bottles)



bbi Scancode	BBI-44430064
Manufacturer	bbi-biotech GmbH
Country of Origin	DE 
HS-Code	73269098
Material	Stainless steel 316L

Components	1x bottle holder
Related Products	<p>5 L bottle holder 3-way (for 0.5 L bottles) (BBI-44430065)</p> <p>Bottle holder for 0.25 L bottles (BBI-44430060)</p> <p>Bottle holder for 0.5 L bottles (BBI-44430061)</p>
<p>Description:</p> <ul style="list-style-type: none"> • For three media bottles 250 ml • To be mounted on 5 L stand [BBI-44430031] • Bottle not included 	



Alle / Verkaufsartikel / Accessories / Culture vessels / Bottle holders

5 L bottle holder 3-way (for 0.5 L bottles)



bbi Scancode	BBI-44430065
Manufacturer	bbi-biotech GmbH
Country of Origin	DE 
HS-Code	73269098
Material	Stainless steel 316L

Components	1x bottle holder
Related Products	<p>5 L bottle holder 3-way (for 0.25 L bottles) (BBI-44430064)</p> <p>Bottle holder for 0.25 L bottles (BBI-44430060)</p> <p>Bottle holder for 0.5 L bottles (BBI-44430061)</p>
<p>Description:</p> <ul style="list-style-type: none"> • For three media bottles 500 ml • To be mounted on 5 L stand [BBI-44430031] • Bottle not included 	



Alle / Verkaufsartikel / Accessories / Culture vessels / Bottle holders

10 L bottle holder 3-way (for 0.25 L bottles)



bbi Scancode	BBI-44430066
Manufacturer	bbi-biotech GmbH
Country of Origin	DE 
HS-Code	73269098
Material	Stainless steel 316L

Components	1x bottle holder
<p>Description:</p> <ul style="list-style-type: none"> • For three media bottles 250 ml • To be mounted on 10 L stand [BBI-44430041] • Bottle not included 	



Alle / Verkaufsartikel / Accessories / Culture vessels / Bottle holders

10 L bottle holder 3-way (for 0.5 L bottles)



bbi Scancode	BBI-44430067
Manufacturer	bbi-biotech GmbH
Country of Origin	DE 
HS-Code	73269098
Material	Stainless steel 316L

Components

1x bottle holder

Description:

- For three media bottles 500 ml
- To be mounted on 10 L stand [BBI-44430041]
- Bottle not included



To the Shop:



Alle / Verkaufsartikel / Accessories / Culture vessels / Bottle holders

1 L bottle holder 3-way (for 0.25 L bottles)



bbi Scancode	BBI-44430068
Manufacturer	bbi-biotech GmbH
Country of Origin	DE 
HS-Code	73269098
Material	Stainless steel 316L

Components	1x bottle holder
Related Products	1 L stainless steel stand (BBI-44430011) 2 L bottle holder 3-way (for 0.25 L bottles) (BBI-44430062) Bottle holder for 0.25 L bottles (BBI-44430060)
<p>Description:</p> <ul style="list-style-type: none"> • For three media bottles 250 ml • To be mounted on 1 L stand [BBI-44430011] • Bottle not included 	



Alle / Verkaufsartikel / Accessories / Culture vessels / Bottle holders

1 L bottle holder 3-way (for 0.5 L bottles)



bbi Scancode	BBI-44430069
Manufacturer	bbi-biotech GmbH
Country of Origin	DE 
HS-Code	73269098
Material	Stainless steel 316L

Components	1x bottle holder
Related Products	<p>1 L stainless steel stand (BBI-44430011)</p> <p>Bottle holder for 0.5 L bottles (BBI-44430061)</p> <p>Reservoir bottle 250 ml with 2 hose nozzles 4 x 1 mm (BBI-44130500)</p>
<p>Description:</p> <ul style="list-style-type: none"> • For three media bottles 500 ml • To be mounted on 1 L stand [BBI-44430011] • Bottle not included 	



Alle / Verkaufsartikel / Accessories / Culture vessels / Vessels

0.5 L jacketed glass vessel



bbi Scancode	BBI-44430004
Manufacturer	bbi-biotech GmbH
External Thread	GL 14
Country of Origin	DE 
HS-Code	70179000
Material	borosilicate glass

Components	1x glass vessel
Related Products	<ul style="list-style-type: none"> 0.5 L lid (BBI-44430002) 0.5 L single-walled glass vessel (BBI-44430300) 0.5 L stainless steel stand (BBI-44430001)
<p>Description:</p> <ul style="list-style-type: none"> • For cultivation of biological cultures • Minimal volume for starter cultures • Total volume: 0.86 L • Minimum working volume: 0.22 L • GL 14 connection • With scaling 	



Alle / Verkaufsartikel / Accessories / Culture vessels / Vessels

1 L jacketed glass vessel



bbi Scancode	BBI-44430014
Manufacturer	bbi-biotech GmbH
External Thread	GL 14
Country of Origin	DE 
HS-Code	70179000
Weight	1.83 kg
Material	borosilicate glass

Components	1x glass vessel
Related Products	1 L o-ring (BBI-45100021) 1 L single-walled glass vessel (BBI-44430301) Hose connection set vessel GL 14 (BBI-44430110)

Description:

- For cultivation of biological cultures
- Minimal volume for starter cultures
- Total volume: 1.63 L
- Minimum working volume: 0.29 L
- GL 14 connection
- With scaling



To the Shop:



Alle / Verkaufsartikel / Accessories / Culture vessels / Vessels

2 L jacketed glass vessel



bbi Scancode	BBI-44430024
Manufacturer	bbi-biotech GmbH
External Thread	GL 14
Country of Origin	DE 
HS-Code	70179000
Weight	2.8 kg
Material	borosilicate glass

Components	1x glass vessel
Related Products	2 L lid (BBI-44430022) 2 L single-walled glass vessel (BBI-44430302) 2 L stainless steel stand (BBI-44430021)
Description: <ul style="list-style-type: none"> • For cultivation of biological cultures • Total volume: 3.18 L • Minimum working volume: 0.51 L • GL 14 connection • With scaling 	



To the Shop:



Alle / Verkaufsartikel / Accessories / Culture vessels / Vessels

2 L jacketed stainless steel vessel



bbi Scancode	BBI-44430026
Manufacturer	bbi-biotech GmbH
Material Certificate	3.1, Rauigkeit
Material	Stainless steel 316L

Components	1x stainless steel vessel
Related Products	2 L exhaust cooler, M 26 x 1 (BBI-43930005) 2 L lid for stainless steel vessel (BBI-44430028) 2 L stirrer shaft, 10 mm (BBI-43230041)
Description: <ul style="list-style-type: none"> • For cultivation of biological cultures • Total volume: L • Minimum working volume: L • Autoclavable stainless steel vessels • Pressure control up to 2 bar possible 	



To the Shop:



Alle / Verkaufsartikel / Accessories / Culture vessels / Vessels

5 L jacketed stainless steel vessel



bbi Scancode	BBI-44430027
Manufacturer	bbi-biotech GmbH
Material Certificate	3.1, Rauigkeit
Material	Stainless steel 316L

Components	1x stainless steel vessel
Related Products	2 L jacketed stainless steel vessel (BBI-44430026) 5 L lid for stainless steel vessel (BBI-44430037) 5 L stirrer shaft, 10 mm (BBI-43230046)
Description: <ul style="list-style-type: none"> • For cultivation of biological cultures • Total volume: L • Minimum working volume: L • Autoclavable stainless steel vessels • Pressure control up to 2 bar possible 	



To the Shop:



Alle / Verkaufsartikel / Accessories / Culture vessels / Vessels

5 L jacketed glass vessel



bbi Scancode	BBI-44430034
Manufacturer	bbi-biotech GmbH
External Thread	GL 18
Country of Origin	DE 
HS-Code	70179000
Material	borosilicate glass

Components	1x glass vessel
Related Products	<p>5 L double-wall vessel, complete with accessories CC without sensors (BBI-44439050)</p> <p>5 L double-wall vessel, complete with accessories MO without sensors (BBI-44438050)</p> <p>5 L single-walled glass vessel (BBI-44430303)</p>
<p>Description:</p> <ul style="list-style-type: none"> • For cultivation of biological cultures • Total volume: 6.80 L • Minimum working volume: 0.75 L • GL 18 connection • With scaling 	



Alle / Verkaufsartikel / Accessories / Culture vessels / Vessels

10 L jacketed glass vessel



bbi Scancode	BBI-44430044
Manufacturer	bbi-biotech GmbH
External Thread	GL 18
Country of Origin	DE 
HS-Code	70179000
Material	borosilicate glass

Components	1x glass vessel
Related Products	<p>10 L double-wall vessel, complete with accessories CC without sensors (BBI-44439100)</p> <p>10 L single-walled glass vessel (BBI-44430304)</p> <p>10 L stainless steel stand (BBI-44430041)</p>
<p>Description:</p> <ul style="list-style-type: none"> • For cultivation of biological cultures • Total volume: 12.93 L • Minimum working volume: 1.56 L • GL 18 connection • With scaling 	



Alle / Verkaufsartikel / Accessories / Culture vessels / Vessels

0.25 L jacketed glass vessel



bbi Scancode	BBI-44430054
Manufacturer	bbi-biotech GmbH
External Thread	GL 14
Weight	0.94 kg
Material	borosilicate glass

Components	1x glass vessel
Related Products	0,25 L lid (BBI-44430352) 0.25 L single-walled glass vessel (BBI-44430299) 0.25 L stirrer shaft, 6 mm (BBI-43230047)
Description: <ul style="list-style-type: none"> • For cultivation of biological cultures • Minimal volume for starter cultures • GL 14 connection • With scaling 	



To the Shop:



Alle / Verkaufsartikel / Accessories / Culture vessels / Vessels

0.5 L bubble column



bbi Scancode	BBI-44430070
Manufacturer	bbi-biotech GmbH
External Thread	GL 14
Country of Origin	DE 
HS-Code	70179000
Weight	1.19 kg
Material	borosilicate glass

Components	1x bubble column
Related Products	<ul style="list-style-type: none"> 1 L bubble column (BBI-44430071) Clip for lid bubble column and 0.25 L vessel (BBI-44430073) Lid bubble column (BBI-44430072)

Description:

- For cultivation of phototropic cultures
- Double-walled bottom segment
- Made of borosilicate glass
- Connection GL 14
- With scaling
- Can be equipped with aeration accessory, magnetic stirrer and illumination unit



Alle / Verkaufsartikel / Accessories / Culture vessels / Vessels

1 L bubble column



bbi Scancode	BBI-44430071
Manufacturer	bbi-biotech GmbH
External Thread	GL 14
Country of Origin	DE 
HS-Code	70179000
Material	borosilicate glass

Components	1x bubble column
Related Products	<p>Clip for lid bubble column and 0.25 L vessel (BBI-44430073)</p> <p>Hose connection set vessel GL 14 (BBI-44430110)</p> <p>Lid bubble column (BBI-44430072)</p>
<p>Description:</p> <ul style="list-style-type: none"> • For cultivation of phototropic cultures • Double-walled bottom segment • Made of borosilicate glass • Connection GL 14 • With scaling • Can be equipped with aeration accessory, magnetic stirrer and illumination unit 	



Alle / Verkaufsartikel / Accessories / Culture vessels / Vessels

Hose connection set vessel GL 14



bbi Scancode	BBI-44430110
Manufacturer	bbi-biotech GmbH
Internal Thread	GL 14
Country of Origin	DE 
Weight	0.09 kg

Components	2x hose connection
Consumables	Olive, curved, GL 14 (BBI-44430100) Screw cap GL 14 with hole (package of 10 pieces) (BBI-44130457)
Related Products	Hose connection set supply-tempering module (BBI-44430114) Hose connection set vessel GL 18 (BBI-44430111) Hose connection set vessel-tempering module (BBI-44430112)
Description: <ul style="list-style-type: none"> • For connection to double-walled glass vessel with GL 14 • Tube with quick connect couplings and hose nozzles 	



To the Shop:



Alle / Verkaufsartikel / Accessories / Culture vessels / Vessels

Hose connection set vessel GL 18



bbi Scancode	BBI-44430111
Manufacturer	bbi-biotech GmbH
Internal Thread	GL 18
Country of Origin	DE 
Weight	0.06 kg

Components	2x hose connection
Consumables	Olive, curved, GL 18 (BBI-44430101) Screw cap GL 18 with hole (package of 10 pieces) (BBI-44130452)
Related Products	Hose connection set supply-tempering module (BBI-44430114) Hose connection set vessel GL 14 (BBI-44430110) Hose connection set vessel-tempering module (BBI-44430112)
Description: <ul style="list-style-type: none"> • For connection to double-walled glass vessel with GL 18 • Tube with quick connect couplings and hose nozzles 	



To the Shop:



Alle / Verkaufsartikel / Accessories / Culture vessels / Vessels

0.25 L single-walled glass vessel



bbi Scancode	BBI-44430299
Manufacturer	bbi-biotech GmbH
Country of Origin	DE 
HS-Code	70179000
Material	borosilicate glass

Components	1x glass vessel
Related Products	<p>0,25 L lid (BBI-44430352)</p> <p>0.25 L jacketed glass vessel (BBI-44430054)</p> <p>0.25 L stirrer shaft, 6 mm (BBI-43230047)</p>
<p>Description:</p> <ul style="list-style-type: none"> • For the cultivation of biological cultures • Single-walled vessel made of borosilicate glass • With scaling 	



Alle / Verkaufsartikel / Accessories / Culture vessels / Vessels

0.5 L single-walled glass vessel



bbi Scancode	BBI-44430300
Manufacturer	bbi-biotech GmbH
Country of Origin	DE 
HS-Code	70179000
Material	borosilicate glass

Components	1x glass vessel
Related Products	0.5 L jacketed glass vessel (BBI-44430004) 0.5 L lid (BBI-44430002) 0.5 L stainless steel stand (BBI-44430001)

Description:

- For the cultivation of biological cultures
- Single-walled vessel made of borosilicate glass
- With scaling
- Total volume: 0.86 L
- Minimum working volume: 0.22 L
- Also available in other sizes



To the Shop:



Alle / Verkaufsartikel / Accessories / Culture vessels / Vessels

1 L single-walled glass vessel



bbi Scancode	BBI-44430301
Manufacturer	bbi-biotech GmbH
Country of Origin	DE 
HS-Code	70179000
Material	borosilicate glass

Components 1x glass vessel

Description:

- For the cultivation of biological cultures
- Single-walled vessel made of borosilicate glass
- With scaling
- Total volume: 1.63 L
- Minimum working volume: 0.29 L
- Also available in other sizes



To the Shop:



Alle / Verkaufsartikel / Accessories / Culture vessels / Vessels

2 L single-walled glass vessel



bbi Scancode	BBI-44430302
Manufacturer	bbi-biotech GmbH
Country of Origin	DE 
HS-Code	70179000
Weight	1.38 kg
Material	borosilicate glass

Components	1x glass vessel
Related Products	2 L jacketed glass vessel (BBI-44430024) 2 L lid (BBI-44430022) 2 L stainless steel stand (BBI-44430021)

Description:

- For the cultivation of biological cultures
- Single-walled vessel made of borosilicate glass
- With scaling
- Total volume: 3.18 L
- Minimum working volume: 0.51 L
- Also available in other sizes



To the Shop:



Alle / Verkaufsartikel / Accessories / Culture vessels / Vessels

5 L single-walled glass vessel



bbi Scancode	BBI-44430303
Manufacturer	bbi-biotech GmbH
Country of Origin	DE 
HS-Code	70179000
Material	borosilicate glass

Components	1x glass vessel
Related Products	<p>5 L jacketed glass vessel (BBI-44430034)</p> <p>5 L vessel SW complete with 2 spargers CC without sensors and heating jacket (BBI-44437051)</p> <p>5 L vessel SW complete with standard accessories CC without sensors and heating jacket (BBI-44437050)</p>

Description:

- For the cultivation of biological cultures
- Single-walled vessel made of borosilicate glass
- With scaling
- Total volume: 6.80 L
- Minimum working volume: 0.75 L
- Also available in other sizes



Alle / Verkaufsartikel / Accessories / Culture vessels / Vessels

10 L single-walled glass vessel



bbi Scancode	BBI-44430304
Manufacturer	bbi-biotech GmbH
Country of Origin	DE 
HS-Code	70179000
Weight	3.7 kg
Material	borosilicate glass

Components	1x glass vessel
Related Products	<p>10 L jacketed glass vessel (BBI-44430044)</p> <p>10 L stainless steel stand (BBI-44430041)</p> <p>10 L vessel SW complete with standard accessories CC without sensors and heating jacket (BBI-44437100)</p>

Description:

- For the cultivation of biological cultures
- Single-walled vessel made of borosilicate glass
- With scaling
- Total volume: 12.93 L
- Minimum working volume: 1.56 L
- Also available in other sizes



Alle / Verkaufsartikel / Accessories / Culture vessels / O-rings for lid

0.5 L o-ring



bbi Scancode	BBI-45100020
Manufacturer	bbi-biotech GmbH
Material Certificate	FDA
Country of Origin	IT 
HS-Code	40169300
Material	EPDM black

Components	1x o-ring
Related Products	<p>0.5 L jacketed glass vessel (BBI-44430004)</p> <p>0.5 L lid (BBI-44430002)</p> <p>2 L o-ring (BBI-45100022)</p>
<p>Description:</p> <ul style="list-style-type: none"> • Suitable for 0.5 L lid [BBI-44430002] • Spare part for bioreactors 	



Alle / Verkaufsartikel / Accessories / Culture vessels / O-rings for lid

1 L o-ring



bbi Scancode	BBI-45100021
Manufacturer	bbi-biotech GmbH
Material Certificate	FDA
Country of Origin	IT 
HS-Code	40169300
Weight	0.01 kg
Material	EPDM black

Components	1x o-ring
Description: <ul style="list-style-type: none"> • Suitable for 1 L lid [BBI-44430012] • Spare part for bioreactors 	



Alle / Verkaufsartikel / Accessories / Culture vessels / O-rings for lid

2 L o-ring



bbi Scancode	BBI-45100022
Manufacturer	bbi-biotech GmbH
Material Certificate	FDA
Country of Origin	EU 
HS-Code	40169300
Weight	0.01 kg
Material	EPDM black

Components	1x o-ring
Related Products	2 L jacketed glass vessel (BBI-44430024) 2 L lid (BBI-44430022) 2 L stainless steel stand (BBI-44430021)
Description: <ul style="list-style-type: none"> • Suitable for 2 L lid [BBI-44430022] • Spare part for bioreactors 	



Alle / Verkaufsartikel / Accessories / Culture vessels / O-rings for lid

5 L o-ring



bbi Scancode	BBI-45100023
Manufacturer	bbi-biotech GmbH
Material Certificate	FDA
Country of Origin	IT 
HS-Code	40169300
Weight	0.01 kg
Material	EPDM black

Components	1x o-ring
Related Products	<p>5 L jacketed glass vessel (BBI-44430034)</p> <p>5 L lid (BBI-44430032)</p> <p>5 L single-walled glass vessel (BBI-44430303)</p>
<p>Description:</p> <ul style="list-style-type: none"> • Suitable for 5 L lid [BBI-44430032] • Spare part for bioreactors 	



Alle / Verkaufsartikel / Accessories / Culture vessels / O-rings for lid

10 L o-ring



bbi Scancode	BBI-45100024
Manufacturer	bbi-biotech GmbH
Material Certificate	FDA
Country of Origin	IT 
HS-Code	40169300
Weight	0.01 kg
Material	EPDM black

Components	1x o-ring
Related Products	<p>10 L jacketed glass vessel (BBI-44430044)</p> <p>10 L lid (BBI-44430042)</p> <p>10 L stainless steel stand (BBI-44430041)</p>
<p>Description:</p> <ul style="list-style-type: none"> • Suitable for 10 L lid [BBI-44430042] • Spare part for bioreactors 	



Alle / Verkaufsartikel / Accessories / Culture vessels / Stainless steel stands

0.5 L stainless steel stand



bbi Scancode	BBI-44430001
Manufacturer	bbi-biotech GmbH
Internal Thread	M 8
Country of Origin	DE 
HS-Code	73269098
Weight	1.09 kg
Material	Stainless steel 316L

Components	1x stand, 3x teflon pads [BBI-44430203]
Consumables	Support for glass vessel (BBI-44430203)
Related Products	0.5 L jacketed glass vessel (BBI-44430004) 0.5 L lid (BBI-44430002) 0.5 L stirrer shaft, 8 mm (BBI-43230042)

Description:

- Stainless steel stand for 0.5 L culture vessels
- Made of stainless steel



Alle / Verkaufsartikel / Accessories / Culture vessels / Stainless steel stands

1 L stainless steel stand



bbi Scancode	BBI-44430011
Manufacturer	bbi-biotech GmbH
Internal Thread	M 8
Country of Origin	DE 
HS-Code	73269098
Weight	1.39 kg
Material	Stainless steel 316L

Components	1x stand, 3x teflon pads [BBI-44430203]
Consumables	Support for glass vessel (BBI-44430203)
Description: <ul style="list-style-type: none"> • Stainless steel stand for 1 L culture vessels • Made of stainless steel 	



To the Shop:



Alle / Verkaufsartikel / Accessories / Culture vessels / Stainless steel stands

2 L stainless steel stand



bbi Scancode	BBI-44430021
Manufacturer	bbi-biotech GmbH
Internal Thread	M 8
Country of Origin	DE 
HS-Code	73269098
Weight	1.56 kg
Material	Stainless steel 316L

Components	1x stand, 3x teflon pads [BBI-44430203]
Consumables	Support for glass vessel (BBI-44430203)
Related Products	2 L jacketed glass vessel (BBI-44430024) 2 L lid (BBI-44430022) 2 L single-walled glass vessel (BBI-44430302)
Description: <ul style="list-style-type: none"> • Stainless steel stand for 2 L culture vessels • Made of stainless steel 	



To the Shop:



Alle / Verkaufsartikel / Accessories / Culture vessels / Stainless steel stands

5 L stainless steel stand



bbi Scancode	BBI-44430031
Manufacturer	bbi-biotech GmbH
Internal Thread	M 8
Country of Origin	DE 
HS-Code	73269098
Weight	2.71 kg
Material	Stainless steel 316L

Components	1x stand, 3x teflon pads [BBI-44430203]
Consumables	Support for glass vessel (BBI-44430203)
Related Products	5 L jacketed glass vessel (BBI-44430034) 5 L lid (BBI-44430032) 5 L single-walled glass vessel (BBI-44430303)
Description: <ul style="list-style-type: none"> • Stainless steel stand for 5 L culture vessels • Made of stainless steel 	



Alle / Verkaufsartikel / Accessories / Culture vessels / Stainless steel stands

10 L stainless steel stand



bbi Scancode	BBI-44430041
Manufacturer	bbi-biotech GmbH
Internal Thread	M 8
Country of Origin	DE 
HS-Code	73269098
Weight	4.98 kg
Material	Stainless steel 316L

Components	1x stand, 6x teflon pads [BBI-44430203]
Consumables	Support for glass vessel (BBI-44430203)
Related Products	10 L jacketed glass vessel (BBI-44430044) 10 L lid (BBI-44430042) 10 L single-walled glass vessel (BBI-44430304)
Description: <ul style="list-style-type: none"> • Stainless steel stand for 10 L culture vessels • Made of stainless steel 	



Alle / Verkaufsartikel / Accessories / Culture vessels / Stainless steel stands

Support for glass vessel



bbi Scancode	BBI-44430203
Manufacturer	bbi-biotech GmbH
Country of Origin	DE 
HS-Code	0
Weight	0.02 kg
Material	Stainless steel 316L PEEK

Components	1x stand support
Consumables	Support for glass vessel (BBI-44430203)
Related Products	2 L stainless steel stand (BBI-44430021) Support for glass vessel 0.5 - 5 L (set) (BBI-44430204) Support for glass vessel 10 L (set) (BBI-44430205)
Description: <ul style="list-style-type: none"> • Support for glass vessel laying on the stand • Made of teflon / PTFE 	



Alle / Verkaufsartikel / Accessories / Culture vessels / Stainless steel stands

Support for glass vessel 0.5 - 5 L (set)



bbi Scancode	BBI-44430204
Manufacturer	bbi-biotech GmbH
Country of Origin	DE 
Material	Stainless steel 316L PEEK

Components	3x stand support
Related Products	5 L stainless steel stand (BBI-44430031) Support for glass vessel (BBI-44430203) Support for glass vessel 10 L (set) (BBI-44430205)
Description: <ul style="list-style-type: none"> • Support for glass vessel laying on the stand • Made of teflon / PTFE • Set for 0.5 L, 1 L, 2 L, 5 L glass vessels 	



To the Shop:



Alle / Verkaufsartikel / Accessories / Culture vessels / Stainless steel stands

Support for glass vessel 10 L (set)



bbi Scancode	BBI-44430205
Manufacturer	bbi-biotech GmbH
Country of Origin	DE 
Material	Stainless steel 316L PEEK

Components	6x stand support
Related Products	10 L stainless steel stand (BBI-44430041) Support for glass vessel (BBI-44430203) Support for glass vessel 0.5 - 5 L (set) (BBI-44430204)
Description: <ul style="list-style-type: none"> • Support for glass vessel laying on the stand • Made of teflon / PTFE • Set for 10 L glass vessels 	





To the Shop:

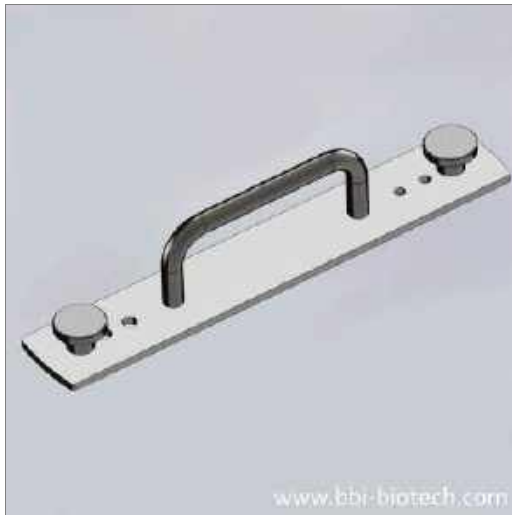

Alle / Verkaufsartikel / Accessories / Culture vessels / Stainless steel stands

Safety clamp with handle for 2 L to 10 L vessels



bbi Scancode	BBI-44430211
Manufacturer	bbi-biotech GmbH
External Thread	M 8
Country of Origin	DE 
Material	Stainless steel 316L

Components	1x safety clamp with handle and knurled screws
Related Products	10 L stainless steel stand (BBI-44430041) 2 L stainless steel stand (BBI-44430021) 5 L stainless steel stand (BBI-44430031)
Description: <ul style="list-style-type: none"> • For mounting on the stand • The glass vessel can be transported together with the stand (without lid) using a handle 	



To the Shop:



Alle / Verkaufsartikel / Accessories / Assembly accessories / Consumable starter sets

Consumable Starter Set Autoclavables



bbi Scancode	BBI-45110100
Manufacturer	bbi-biotech GmbH
Material Certificate	FDA
Country of Origin	DE 
Weight	0.49 kg

Components	1x silicone tube 3.2x1.6mm (5m) [BBI-44130605], 1x innovaprene hose; 5m; 0,5mm x 1,0mm [BBI-44130613], 3x syringe filter 30mm 0,22µm, 1x silicone tube 1.6x1.6mm (5m) [BBI-44130604], 1x silicone tube 2,0x1,0mm (5m) [BBI-44130612], 1x sterile filter
Related Products	Wear parts set for 1 L vessels xCUBIO (BBI-45110603) Wear parts set for 10 L vessels xCUBIO (BBI-45110606) Wear parts set for 2 L vessels xCUBIO (BBI-45110604)

Description:

- Starter set for autoclavable bioreactors
- Includes all necessary accessories and spare parts for the process in the bioreactor
- Including various hoses, O-rings and filters



Alle / Verkaufsartikel / Accessories / Assembly accessories / Gaskets

Replacement set of seals for stirrer shaft (0.5 - 10 L)



bbi Scancode	BBI-43930203
Manufacturer	bbi-biotech GmbH
Material Certificate	FDA
Country of Origin	DE 
Material	EPDM black

Components	1x o-ring; 1x v-seal
Related Products	0.5 L stirrer shaft, 8 mm (BBI-43230042) 1 L stirrer shaft, 10 mm (BBI-43230040) 10 L stirrer shaft, 16 mm (BBI-43230044)
Description: Replacement gaskets for your agitator shafts 0.5 to 10 L	



To the Shop:



Alle / Verkaufsartikel / Accessories / Assembly accessories / Gaskets

Flat seal for 12 mm ports (Package of 5 pieces)



bbi Scancode	BBI-44130210
Manufacturer	bbi-biotech GmbH
Material Certificate	FDA
Country of Origin	EU 
HS-Code	40169300
Weight	0.01 kg
Material	EPDM black

Components	5x flat seal
Related Products	<p>Flat seal with hole for 12 mm ports (package of 5 pieces) (BBI-44130214)</p> <p>Membrane 19mm (Package of 20 pieces) (BBI-44130004)</p> <p>Seal for screw cap GL 25 (package of 10 pieces) (BBI-44130455)</p>
<p>Description:</p> <ul style="list-style-type: none"> • Suitable for blind plug Pg 13.5 [BBI-44130206] • Package of 5 pieces 	



Alle / Verkaufsartikel / Accessories / Assembly accessories / Gaskets

Flat seal with hole for 12 mm ports (package of 5 pieces)



bbi Scancode	BBI-44130214
Manufacturer	bbi-biotech GmbH
Material Certificate	FDA
Country of Origin	EU 
HS-Code	40169300
Weight	0.01 kg
Material	EPDM black

Components	5x flat seal
Related Products	<p>Flat seal for 12 mm ports (Package of 5 pieces) (BBI-44130210)</p> <p>Membrane 19 mm (Package of 20 pieces) (BBI-44130021)</p> <p>Seal for screw cap GL 45 (package of 10 pieces) (BBI-44130451)</p>
<p>Description:</p> <ul style="list-style-type: none"> • Suitable for 3-way addition ports Pg 13.5 e.g. [BBI-43630253] or [BBI-43630252] • Package of 5 pieces • Seal with hole 	



Alle / Verkaufsartikel / Accessories / Assembly accessories / Gaskets

Seal for screw cap GL 45 (package of 10 pieces)



bbi Scancode	BBI-44130451
Manufacturer	bbi-biotech GmbH
Material Certificate	FDA
Country of Origin	DE 
HS-Code	40169300
Weight	0.02 kg
Material	silicone transparent

Components	10x seal
Related Products	<p>Screw cap GL 45 with hole (set: red, yellow, green, blue) (BBI-44130473)</p> <p>Screw cap GL 45 with hole, green (package of 10 pieces) (BBI-44130470)</p> <p>Screw cap GL 45 with hole, red (package of 10 pieces) (BBI-44130450)</p>
<p>Description:</p> <ul style="list-style-type: none"> • Seal for screw cap GL 45 • Clear Silicone Rubber Gasket 42 mm OD x 30 mm ID • Package: 10 pieces 	



Alle / Verkaufsartikel / Accessories / Assembly accessories / Gaskets

Seal for screw cap GL 18 (package of 10 pieces)



bbi Scancode	BBI-44130453
Manufacturer	bbi-biotech GmbH
Material Certificate	FDA
Country of Origin	DE 
HS-Code	40169300
Weight	0.01 kg
Material	silicone transparent

Components	10x seal
Related Products	<p>Screw cap GL 18 with hole (package of 10 pieces) (BBI-44130452)</p> <p>Screw cap GL 18 with hose nozzle (BBI-44130459)</p> <p>Seal for screw cap GL 25 (package of 10 pieces) (BBI-44130455)</p>
<p>Description:</p> <ul style="list-style-type: none"> • Seal for screw cap GL 18 • Clear Silicone Rubber Gasket 16 mm OD x 10 mm ID • Package: 10 pieces 	



Alle / Verkaufsartikel / Accessories / Assembly accessories / Gaskets

Seal for screw cap GL 25 (package of 10 pieces)



bbi Scancode	BBI-44130455
Manufacturer	bbi-biotech GmbH
Material Certificate	FDA
Country of Origin	DE 
HS-Code	40169300
Weight	0.01 kg
Material	silicone transparent

Components	10x seal
Related Products	<p>Screw cap GL 25 with hole (for manual sampler) (BBI-44130456)</p> <p>Screw cap GL 25 with hole (package of 10 pieces) (BBI-44130454)</p> <p>Seal for screw cap GL 18 (package of 10 pieces) (BBI-44130453)</p>
<p>Description:</p> <ul style="list-style-type: none"> • Seal for screw cap GL 25 • Clear Silicone Rubber Gasket 23 mm OD x 17 mm ID • Package: 10 pieces 	



Alle / Verkaufsartikel / Accessories / Assembly accessories / Gaskets

Seal for screw cap GL 32 (package of 10 pieces)



bbi Scancode	BBI-44130462
Manufacturer	bbi-biotech GmbH
Material Certificate	FDA
Country of Origin	DE 
HS-Code	40169300
Weight	0.01 kg
Material	silicone transparent

Components	10x seal
Related Products	<p>Screw cap GL 32 with hole (package of 10 pieces) (BBI-44130461)</p> <p>Seal for screw cap GL 32 (package of 10 pieces) (BBI-44130462)</p> <p>Seal for screw cap GL 45 (package of 10 pieces) (BBI-44130451)</p>
<p>Description:</p> <ul style="list-style-type: none"> • Seal for screw cap GL 18 • Clear Silicone Rubber Gasket 29 mm OD x 25 mm ID • Package: 10 pieces 	



Alle / Verkaufsartikel / Accessories / Assembly accessories / Gaskets

Seal for screw cap GLS 80 (package of 5 pieces)

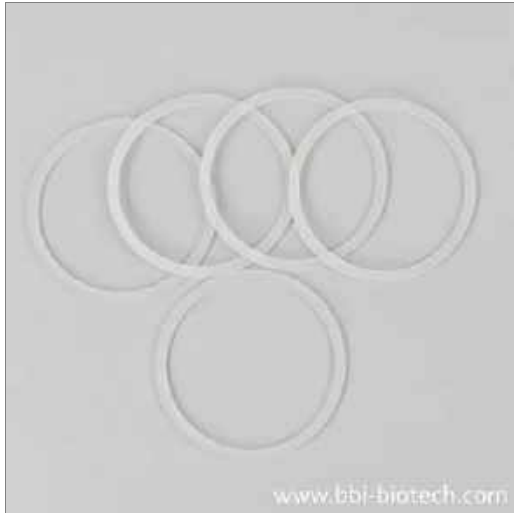

bbi Scancode	BBI-44130463
Manufacturer	bbi-biotech GmbH
Material Certificate	FDA
Country of Origin	DE 
HS-Code	39269097
Material	silicone transparent

Components	5x seal
Related Products	<p>1 L wide-neck bottle GLS 80 (BBI-44130583)</p> <p>Screw cap GLS 80 with hole, blue (BBI-44130464)</p> <p>Seal for screw cap GL 45 (package of 10 pieces) (BBI-44130451)</p>
<p>Description:</p> <ul style="list-style-type: none"> • Seal for screw cap GLS 80 • Clear Silicone Rubber Gasket • Package: 5 pieces 	



Alle / Verkaufsartikel / Accessories / Assembly accessories / Gaskets

Membrane 41 x 5.8 x 2 (for bottom valve)



bbi Scancode	BBI-45100102
Manufacturer	bbi-biotech GmbH
Material Certificate	FDA
HS-Code	40169300
Material	EPDM black

Components	1x membrane
Related Products	Membrane 38 x 5.8 x 2 (for sampling valve) (BBI-45100100) Membrane for sampling valve or AP19 (BBI-45100101) Membrane/septa for inoculation port or manual bypass sampler (package of 10 pieces) (BBI-43830001)
Description: <ul style="list-style-type: none"> • Suitable for bottom valves • Spare part for bioreactors 	



To the Shop:



Alle / Verkaufsartikel / Accessories / Assembly accessories / Gaskets

Membrane 22 x 15 x 2 EPDM FDA/USP (package: 1 piece)



bbi Scancode	BBI-45100103
Manufacturer	bbi-biotech GmbH
Material Certificate	FDA
HS-Code	40169300
Material	EPDM black

Components	1x membrane
Related Products	Membrane 22 x 15 x 2 EPDM FDA/USP (package: 10 pieces) (BBI-45100104) Membrane 38 x 5.8 x 2 (for sampling valve) (BBI-45100100) Membrane for sampling valve or AP19 (BBI-45100101)
Description:	



To the Shop:



Alle / Verkaufsartikel / Accessories / Assembly accessories / Gaskets

Gasket TC25 for hose connector exhaust cooler (package of 5 pieces)



bbi Scancode	BBI-45100302
Manufacturer	bbi-biotech GmbH
Material Certificate	FDA
Country of Origin	CN 
HS-Code	40169300
Weight	0.01 kg
Material	EPDM

Components	5x gasket
Related Products	<ul style="list-style-type: none"> 0.5-1 L exhaust cooler, M 26 x 1 (BBI-43930008) 2 L exhaust cooler, M 26 x 1 (BBI-43930005) 5-10 L exhaust cooler, M 26 x 1 (BBI-43930007)
<p>Description:</p> <p>Sealing for triclamp 25 mm with hole 16.2</p>	



Alle / Verkaufsartikel / Accessories / Assembly accessories / Membranes

Membrane/septa for inoculation port or manual bypass sampler (package of 10 pieces)



bbi Scancode	BBI-43830001
Manufacturer	bbi-biotech GmbH
Material Certificate	FDA
Country of Origin	DE 
HS-Code	40169300
Weight	0.01 kg
Material	silicone

Components	10x membrane
Related Products	Membrane 19 mm (Package of 20 pieces) (BBI-44130021) Membrane 19mm (Package of 20 pieces) (BBI-44130004) Membrane/septa for inoculation port or manual bypass sampler (latex) (package of 10 pieces) (BBI-43830007)

Description:

- Used for manual sampling in bypass
- Used with inoculation needles and cannulas
- The membrane is pinched with a cannula in order to draw a sterile sampling
- Accessorie for manual bypass sampler [BBI-43830000] or inoculation port [BBI-43630200]
- Package: 10 pieces



To the Shop:



Alle / Verkaufsartikel / Accessories / Assembly accessories / Membranes

Membrane/septa for inoculation port or manual bypass sampler (latex) (package of 10 pieces)



bbi Scancode	BBI-43830007
Manufacturer	bbi-biotech GmbH
Material Certificate	FDA
Country of Origin	DE 
HS-Code	39269097
Weight	0.01 kg
Material	Latex

Components	10x membrane
Related Products	Membrane 19 mm (Package of 20 pieces) (BBI-44130021) Membrane 19mm (Package of 20 pieces) (BBI-44130004) Membrane/septa for inoculation port or manual bypass sampler (package of 10 pieces) (BBI-43830001)

Description:

- Used for manual sampling in bypass
- Used with inoculation needles and cannulas
- The membrane is pinched with a cannula in order to draw a sterile sampling
- Accessorie for manual bypass sampler [BBI-43830000] or inoculation port [BBI-43630200]
- Package: 10 pieces



Alle / Verkaufsartikel / Accessories / Assembly accessories / Membranes

Membrane 19mm (Package of 20 pieces)



bbi Scancode	BBI-44130004
Manufacturer	bbi-biotech GmbH
Material Certificate	FDA
Country of Origin	DE 
HS-Code	40169300
Weight	0.07 kg
Material	Brombutyl white

Components	20x membranes
Related Products	Membrane 19 mm (Package of 20 pieces) (BBI-44130021) Membrane Holder Rd 28 x 1/8 (BBI-44130005) Membrane holder M 26 x 1 (BBI-44130018)

Description:

- For use with membrane holder M 26 x 1 [BBI-44130018], membrane holder Rd 28 x 1/8 [BBI-44130005] or membrane holder 25 mm for G 1 1/4 (Ingold port) [BBI-44130117]
- In Weiß
- Material: Brombutyl (FDA-conform)
- For use with addition ports and inoculation needles
- For in-situ and autoclavable systems
- Package: 20 pieces
- Also available with material VMO grey
- No oil resistance; -40 to 120 °C



To the Shop:



Alle / Verkaufsartikel / Accessories / Assembly accessories / Membranes

Membrane 19 mm (Package of 20 pieces)



bbi Scancode	BBI-44130021
Manufacturer	bbi-biotech GmbH
Material Certificate	FDA
Country of Origin	DE 
HS-Code	40169300
Weight	0.05 kg
Material	VMQ gray (silicone rubber)

Components	20x membranes
Related Products	Membrane 19mm (Package of 20 pieces) (BBI-44130004) Membrane Holder Rd 28 x 1/8 (BBI-44130005) Membrane holder M 26 x 1 (BBI-44130018)

Description:

- For use with membrane holder M 26 x 1 [BBI-44130018], membrane holder Rd 28 x 1/8 [BBI-44130005] or membrane holder 25 mm for G 1 1/4 (Ingold port) [BBI-44130117]
- In Grau
- Material: VMQ grey
- For use with inoculation ports
- For in-situ and autoclavable systems
- Package of 20 pieces
- Also available in material Brombutyl
- -50 to 210 °C
- resistant to mineral oils



Alle / Verkaufsartikel / Accessories / Assembly accessories / Membranes

Membrane for STT-couplings (package of 20 pieces)



bbi Scancode	BBI-44130654
Manufacturer	bbi-biotech GmbH
Material Certificate	FDA
Country of Origin	DE 
HS-Code	40169300
Weight	0.01 kg
Material	NK 417 nature

Components	20x membranes
Related Products	STT quick connect coupling (1.6 - 2.0 mm, half, female) (BBI-44130652) STT quick connect coupling (1.6 - 2.0 mm, half, male) (BBI-44130653) STT quick connect coupling (3.2 - 5.0 mm, half, male) (BBI-44130651)
Description: <ul style="list-style-type: none"> • Slit membrane • For use in STT-quick connect couplings female (Art.-No.: BBI-44130650 or BBI-44130652) • Package: 20 pieces 	



To the Shop:



Alle / Verkaufsartikel / Accessories / Assembly accessories / Membranes

Membrane 38 x 5.8 x 2 (for sampling valve)



bbi Scancode	BBI-45100100
Manufacturer	bbi-biotech GmbH
Material Certificate	FDA
HS-Code	40169300
Material	EPDM black

Components	1x membrane
Related Products	Membrane 22 x 15 x 2 EPDM FDA/USP (package: 1 piece) (BBI-45100103) Membrane 41 x 5.8 x 2 (for bottom valve) (BBI-45100102) Membrane for sampling valve or AP1g (BBI-45100101)
Description: <ul style="list-style-type: none"> • Suitable for sampling valves • Spare part for bioreactors 	



To the Shop:



Alle / Verkaufsartikel / Accessories / Assembly accessories / Membranes

Membrane for sampling valve or AP19



bbi Scancode	BBI-45100101
Manufacturer	bbi-biotech GmbH
Material Certificate	FDA
Country of Origin	FR 
HS-Code	40169997
Material	EPDM black

Components	1x membrane
Related Products	Membrane 38 x 5.8 x 2 (for sampling valve) (BBI-45100100) Sampling valve 37 mm (manual) (BBI-43830201) Sterile addition unit AP19 (BBI-43630300)
<p>Description:</p> <ul style="list-style-type: none"> • Suitable for sampling valves [BBI-43830200] and sterile addition unit AP19 [BBI-43630300] • Spare part for bioreactors 	



Alle / Verkaufsartikel / Accessories / Assembly accessories / Membranes

Membrane 22 x 15 x 2 EPDM FDA/USP (package: 10 pieces)



bbi Scancode	BBI-45100104
Manufacturer	bbi-biotech GmbH
Material Certificate	FDA
HS-Code	40169300
Material	EPDM black

Components	10x membranes
Related Products	Membrane 22 x 15 x 2 EPDM FDA/USP (package: 1 piece) (BBI-45100103) Membrane 38 x 5.8 x 2 (for sampling valve) (BBI-45100100) Membrane for sampling valve or AP19 (BBI-45100101)
Description:	



To the Shop:



Alle / Verkaufsartikel / Accessories / Assembly accessories / Material for assembly

Clamping cone (Package of 5 pieces)



bbi Scancode	BBI-44130017
Manufacturer	bbi-biotech GmbH
Country of Origin	DE 
HS-Code	39269097
Weight	0.01 kg
Material	PTFE

Components	5x clamping cone
Related Products	<p>0.5 L Pt100 casing (BBI-43430007)</p> <p>Adapter for 6 mm level probes or dip tubes for harvesting in 11 mm ports (BBI-44630103)</p> <p>Adapter for 6 mm level probes or dip tubes for harvesting in Pg 13.5 ports (BBI-44630106)</p>
<p>Description:</p> <p>Spare part for clamp adapter for antifoam-/level probes or height-adjustable dip tubes with 6 mm diameter</p>	



Alle / Verkaufsartikel / Accessories / Assembly accessories / Material for assembly

Silicone grease, 5 ml



bbi Scancode	BBI-44130901
HS-Code	34039900
Weight	0.01 kg
Material	Unisilikon

Components	1x tin with silicone 5 ml
Related Products	5 L o-ring (BBI-45100023) O-Ring 11.0x1.0 (package of 10 pieces) (BBI-45100030) Stainless steel fitting grease, 5 ml (BBI-44130902)
Description: <ul style="list-style-type: none"> • Is used as a lubricating and sealing grease 	



To the Shop:



Alle / Verkaufsartikel / Accessories / Assembly accessories / Material for assembly

Stainless steel fitting grease, 5 ml



bbi Scancode	BBI-44130902
Country of Origin	DE 
HS-Code	34039900
Weight	0.01 kg
Material	Klüberpaste

Components	1x tin with assembling paste 5 ml
Related Products	Silicone grease, 5 ml (BBI-44130901) Socket key for coupling nut M 10 x 1 (flat) (BBI-44130910)
Description: <ul style="list-style-type: none"> Is used as an assembly paste for transition and clearance fits to prevent fit corrosion 	



To the Shop:



Alle / Verkaufsartikel / Accessories / Assembly accessories / Material for assembly

Socket key for coupling nut M 10 x 1 (flat)



bbi Scancode	BBI-44130910
Manufacturer	bbi-biotech GmbH
Country of Origin	DE 
Weight	0.06 kg

Components	1x tightening tool
Related Products	Blind plug M 10 x 1 (BBI-44130207) Coupling nut M 10 x 1 (flat) (BBI-44130009) Coupling nut M 10 x 1 (high) (BBI-44130010)
Description: <ul style="list-style-type: none"> • Tool for tightening M 10 x 1 coupling nuts on the lid 	



To the Shop:



Alle / Verkaufsartikel / Accessories / Assembly accessories / Material for assembly

Interface cable RS-232 to connect balance to an external device like xCUBIO 1,0 m



bbi Scancode	BBI-44640962
Manufacturer	bbi-biotech GmbH

Components	1x cable
Related Products	Balance cable for Kern balances, external data interface RS-232, interface cable included (BBI-51030202) Ethernet cable 3 m (BBI-51030005) Interface cable RS-232 to connect balance to an external device like xCUBIO 3,0 m (BBI-44640963)
Description: To connect a balance to the xCUBIO controller	



To the Shop:



Alle / Verkaufsartikel / Accessories / Assembly accessories / Material for assembly

Interface cable RS-232 to connect balance to an external device like xCUBIO 3,0 m



bbi Scancode	BBI-44640963
Manufacturer	bbi-biotech GmbH

Components	1x cable
Related Products	Balance cable for Kern balances, external data interface RS-232, interface cable included (BBI-51030202) IEC plug EU standard (BBI-51030011) Interface cable RS-232 to connect balance to an external device like xCUBIO 1,0 m (BBI-44640962)
Description: To connect a balance to the xCUBIO controller	



To the Shop:



Alle / Verkaufsartikel / Accessories / Assembly accessories / Material for assembly

Equipotential bonding cable



bbi Scancode	BBI-44640980
Manufacturer	bbi-biotech GmbH
Country of Origin	DE 
HS-Code	85444290
Weight	0.02 kg

Components	1x cable
Related Products	Antifoam or level probe L=80 mm (BBI-44630002) Cable for antifoam or level probe (BBI-44630010) Equipotential bonding cable, 70 cm (BBI-44640983)
<p>Description:</p> <ul style="list-style-type: none"> • To ensure proper functioning of the level and anti-foam probes, a potential equalization between the controller and the vessel must be established. This is achieved through the equipotential cable, where one end is connected to the controller and the other end is secured in the grounding screw, utilizing the hole for proper attachment • Length = 1 m • Spare part for bioreactors 	



Alle / Verkaufsartikel / Accessories / Assembly accessories / Material for assembly

Equipotential bonding cable (for old controllers)



bbi Scancode	BBI-44640981
Manufacturer	bbi-biotech GmbH
Country of Origin	DE 
HS-Code	85444290
Weight	0.02 kg

Components	1x cable
Related Products	Equipotential bonding cable (BBI-44640980) Equipotential bonding cable (for autoclavable stainless steel vessels) (BBI-44640982) Equipotential bonding cable, 70 cm (BBI-44640983)

Description:

- To ensure proper functioning of the level and anti-foam probes, a potential equalization between the controller and the vessel must be established. This is achieved through the equipotential cable, where one end is connected to the controller and the other end is secured in the grounding screw, utilizing the hole for proper attachment
- Length = 1 m
- Spare part for bioreactors



Alle / Verkaufsartikel / Accessories / Assembly accessories / Material for assembly

Equipotential bonding cable (for autoclavable stainless steel vessels)



bbi Scancode	BBI-44640982
Manufacturer	bbi-biotech GmbH
Country of Origin	DE 
HS-Code	85444290
Weight	0.02 kg

Components	1x cable
Related Products	Equipotential bonding cable (BBI-44640980) Equipotential bonding cable (for old controllers) (BBI-44640981) Equipotential bonding cable, 70 cm (BBI-44640983)
<p>Description:</p> <ul style="list-style-type: none"> • To ensure proper functioning of the level and anti-foam probes, a potential equalization between the controller and the vessel must be established. This is achieved through the equipotential cable, where one end is connected to the controller and the other end is secured in the grounding screw, utilizing the hole for proper attachment • Length = 1 m • Spare part for bioreactors 	



Alle / Verkaufsartikel / Accessories / Assembly accessories / Material for assembly

Equipotential bonding cable, 70 cm



bbi Scancode	BBI-44640983
Manufacturer	bbi-biotech GmbH
Country of Origin	DE 
HS-Code	85444290
Weight	0.02 kg

Components	1x cable
Related Products	Equipotential bonding cable (BBI-44640980) Equipotential bonding cable (for autoclavable stainless steel vessels) (BBI-44640982) Equipotential bonding cable (for old controllers) (BBI-44640981)

Description:

- To ensure proper functioning of the level and anti-foam probes, a potential equalization between the controller and the vessel must be established. This is achieved through the equipotential cable, where one end is connected to the controller and the other end is secured in the grounding screw, utilizing the hole for proper attachment
- Length = 70 cm
- Spare part for bioreactors



Alle / Verkaufsartikel / Accessories / Assembly accessories / Material for assembly

Circlips for items to install in 25 mm Ingold ports (package of 10 pieces)



bbi Scancode	BBI-45110301
HS-Code	73182100
Material	stainless steel

Components	10x circlips
Related Products	Blind plug 25 mm for G 1 ¼" (Ingold socket), standard length 52 mm (BBI-44130202) Circlip for dip tube for harvesting, height-adjustable (package of 10 pieces) (BBI-45110302) Probe adapter 25 mm for G 1 ¼" (Ingold socket) for 12 mm probes (BBI-44130106)
Description: For fastening the coupling nut, e.g. to the 25 mm blind plug or 25 mm probe adapter	



To the Shop:



Alle / Verkaufsartikel / Accessories / Assembly accessories / Material for assembly

Circlip for dip tube for harvesting, height-adjustable (package of 10 pieces)



bbi Scancode	BBI-45110302
Material	stainless steel

Components	10x circlips
Related Products	0.25 L dip tube for harvesting, height-adjustable, ID = 4 mm, without adapter (BBI-43630028) 2 L dip tube for harvesting, height-adjustable, ID = 4 mm, with adapter M 10 x 1 (BBI-43630032) Silicone grease, 5 ml (BBI-44130901)
Description: <ul style="list-style-type: none"> • Spare part for flexible harvesting tubes • Prevents the height-adjustable harvesting tube from slipping into the bioreactor 	



To the Shop:



Alle / Verkaufsartikel / Accessories / Assembly accessories / Material for assembly

Grub screw for ring sparger (package of 10 pieces)



bbi Scancode	BBI-45110501
HS-Code	73181535

Components	10x grub screw
Related Products	0.5 L ring sparger, upwards-facing holes with 0.8 mm (BBI-43530250) 2 L ring sparger, upwards-facing holes with 0.8 mm (BBI-43530252) Grub screw for Rushton stirrer for mounting on the stirrer shaft (package of 10 pieces) (BBI-45110502)
Description: Spare part for ring sparger	



To the Shop:



Alle / Verkaufsartikel / Accessories / Assembly accessories / Material for assembly

Grub screw for blades of 3-bladed-segment impeller & 2-bladed paddle impeller for mounting on the stirrer shaft (package of 10 pieces)



bbi Scancode	BBI-45110503
HS-Code	73181535

Components	10x grub screw
Related Products	<p>Grub screw for 3-bladed-segment impeller & 2-bladed paddle impeller for mounting on the stirrer shaft (package of 10 pieces) (BBI-45110504)</p> <p>Grub screw for Rushton stirrer for mounting on the stirrer shaft (package of 10 pieces) (BBI-45110502)</p> <p>Grub screw for ring sparger (package of 10 pieces) (BBI-45110501)</p>
<p>Description:</p> <p>Ersatzteil für 3-Blatt-Segmentrührer & Paddel-Rührer</p>	



To the Shop:



Alle / Verkaufsartikel / Accessories / Assembly accessories / Material for assembly

Grub screw for 3-bladed-segment impeller & 2-bladed paddle impeller for mounting on the stirrer shaft (package of 10 pieces)



bbi Scancode	BBI-45110504
HS-Code	73181535

Components	10x grub screw
Related Products	<p>Grub screw for Rushton stirrer for mounting on the stirrer shaft (package of 10 pieces) (BBI-45110502)</p> <p>Grub screw for blades of 3-bladed-segment impeller & 2-bladed paddle impeller for mounting on the stirrer shaft (package of 10 pieces) (BBI-45110503)</p> <p>Grub screw for ring sparger (package of 10 pieces) (BBI-45110501)</p>
<p>Description:</p> <p>Ersatzteil für 3-Blatt-Segmentrührer & Paddel-Rührer</p>	



To the Shop:



Alle / Verkaufsartikel / Accessories / Assembly accessories / Material for assembly

Ethernet cable 1 m



bbi Scancode	BBI-51030004
HS-Code	0

Components	1x cable
Related Products	Ethernet cable 3 m (BBI-51030005) Ethernet cable 5 m (BBI-51030006) IEC plug EU standard (BBI-51030011)
Description: Patch cable Cat.5e	



To the Shop:



Alle / Verkaufsartikel / Accessories / Assembly accessories / Material for assembly

Ethernet cable 3 m



bbi Scancode

BBI-51030005

Components	1x cable
Related Products	Ethernet cable 1 m (BBI-51030004) Ethernet cable 5 m (BBI-51030006) IEC plug EU standard (BBI-51030011)
Description: Patch cable Cat.5e	



To the Shop:



Alle / Verkaufsartikel / Accessories / Assembly accessories / Material for assembly

Ethernet cable 5 m



bbi Scancode	BBI-51030006
Weight	0.14 kg

Components	1x cable
Related Products	Ethernet cable 1 m (BBI-51030004) Ethernet cable 3 m (BBI-51030005) IEC plug EU standard (BBI-51030011)
Description: Patch cable Cat.5e	



To the Shop:



Alle / Verkaufsartikel / Accessories / Assembly accessories / Material for assembly

IEC plug EU standard



bbi Scancode	BBI-51030011
HS-Code	0
Weight	0.44 kg

Components	1x cable
Related Products	IEC plug CN Standard (BBI-51030013) IEC plug TW Standard (BBI-51030014) IEC plug US Standard (BBI-51030012)
Description: <ul style="list-style-type: none"> • For xCUBIO controller or tempering modules • EU to IEC plug 	



To the Shop:



Alle / Verkaufsartikel / Accessories / Assembly accessories / Material for assembly

IEC plug US Standard



bbi Scancode	BBI-51030012
HS-Code	0
Weight	0.26 kg

Components	1x cable
Related Products	IEC plug CN Standard (BBI-51030013) IEC plug EU standard (BBI-51030011) IEC plug TW Standard (BBI-51030014)
Description: <ul style="list-style-type: none"> • For xCUBIO controller or tempering modules • USA to IEC plug 	



To the Shop:



Alle / Verkaufsartikel / Accessories / Assembly accessories / Material for assembly

IEC plug CN Standard



bbi Scancode	BBI-51030013
HS-Code	0
Weight	0.3 kg

Components	1x cable
Related Products	IEC plug EU standard (BBI-51030011) IEC plug TW Standard (BBI-51030014) IEC plug US Standard (BBI-51030012)
Description: <ul style="list-style-type: none"> • For xCUBIO controller or tempering modules • China to IEC plug 	



To the Shop:



Alle / Verkaufsartikel / Accessories / Assembly accessories / Material for assembly

IEC plug TW Standard



bbi Scancode

BBI-51030014

Components	1x cable
Related Products	IEC plug CN Standard (BBI-51030013) IEC plug EU standard (BBI-51030011) IEC plug US Standard (BBI-51030012)
Description:	



To the Shop:



Alle / Verkaufsartikel / Accessories / Assembly accessories / Material for assembly

Balance cable for Kern balances, external data interface RS-232, interface cable included



bbi Scancode

BBI-51030202

Components	
Related Products	Interface cable RS-232 to connect balance to an external device like xCUBIO 1,0 m (BBI-44640962) Interface cable RS-232 to connect balance to an external device like xCUBIO 3,0 m (BBI-44640963)
Description: cable length 1 m	



To the Shop:



Alle / Verkaufsartikel / Accessories / Assembly accessories / Consumable sets

Set standard cable for xCUBIO single



bbi Scancode	BBI-44640940
Manufacturer	bbi-biotech GmbH
Country of Origin	DE 

Components	1x equipotential bonding cable [BBI-44640980], 1x cable for antifoam or level probe [BBI-44630010], 2x probe cable VP/VP for standard pH and pO ₂ probes, 2m [BBI-44640901], 1x temperature sensor Pt100, 1 m [BBI-43430020], 1x ethernet cable 3 m [BBI-51030005]
Related Products	Equipotential bonding cable (BBI-44640980) Set Standard Kabel für xCUBIO twin (BBI-44640941) Temperature sensor Pt100, 1 m (BBI-43430020)
Description: Set of all necessary cables for your xCUBIO single controller	



To the Shop:



Alle / Verkaufsartikel / Accessories / Assembly accessories / Consumable sets

Set Standard Kabel für xCUBIO twin



bbi Scancode	BBI-44640941
Manufacturer	bbi-biotech GmbH
Country of Origin	DE 

Components	2x equipotential bonding cable [BBI-44640980], 2x cable for antifoam or level probe [BBI-44630010], 4x probe cable VP/VP for standard pH and pO ₂ probes, 2m [BBI-44640901], 2x temperature sensor Pt100, 1 m [BBI-43430020], 1x ethernet cable 3 m [BBI-51030005]
Related Products	Equipotential bonding cable (BBI-44640980) Set standard cable for xCUBIO single (BBI-44640940) Temperature sensor Pt100, 1 m (BBI-43430020)
<p>Description:</p> <p>Set of all necessary cables for your xCUBIO twin controller</p>	



To the Shop:



Alle / Verkaufsartikel / Accessories / Assembly accessories / Consumable sets

Wear parts set for 0.5 L vessels xCUBIO



bbi Scancode	BBI-45110602
Manufacturer	bbi-biotech GmbH
Material Certificate	FDA
Country of Origin	DE 

Components	<p>1x 0.5 L O-ring [BBI-45100020] 1x O-ring for stirrer shaft [BBI-45100018] 1x Sterile filter gas 50 mm [BBI-44130511] 1x Sterile filter 30 mm 0.2 µm (package of 10 pieces) [BBI-44130510] 1x Membrane for inoculation port or manual bypass sampler (package of 10 pieces) [BBI-43830001] 1x Flat seal for Pg 13.5 (package of 5 pieces) [BBI-44130214] 1x Flat seal for 12 mm ports (Package of 5 pieces) [BBI-44130210] 1x Gasket TC25 for hose connector exhaust cooler (package of 5 pieces) [BBI-45100302] 1x O-ring for items to install in 11 mm ports (package of 10 pieces) [BBI-45100011] 1x O-ring for items to install in M 26 x 1 ports (package of 10 pieces) [BBI-45100015] 1x O-ring for adapter (package of 5 pieces) [BBI-45100025] 1x Silicone grease, 5 ml [BBI-44130901] 1x Stainless steel fitting grease, 5 ml [BBI-44130902] 1x Clamping cone (Package of 5 pieces) [BBI-44130017] 1x O-ring for inoculation port cap (package of 5 pieces) [BBI-45100026] 1x Circlip for dip tube for harvesting, height-adjustable (package of 10 pieces) [BBI-45110302]</p>
Related Products	<p>Wear parts set for 1 L vessels xCUBIO (BBI-45110603) Wear parts set for 2 L vessels xCUBIO (BBI-45110604) Wear parts set for 5 L vessels xCUBIO (BBI-45110605)</p>

Description:

This complete wear parts set contains all components such as o-rings, seals and filters that should be replaced regularly. Your benefits with the wear parts set:

- Suitable for 0.5 L glass vessels and fittings
- No time-consuming search of articles
- No tedious price inquiries
- No long delivery times
- Lower total price compared to the individual parts



Alle / Verkaufsartikel / Accessories / Assembly accessories / Consumable sets

Wear parts set for 1 L vessels xCUBIO



bbi Scancode	BBI-45110603
Manufacturer	bbi-biotech GmbH
Material Certificate	FDA
Country of Origin	DE 

Components	1x 1 L O-ring [BBI-45100021] 1x O-ring for stirrer shaft [BBI-45100018] 1x Sterile filter gas 50 mm [BBI-44130511] 1x Sterile filter 30 mm 0.2 µm (package of 10 pieces) [BBI-44130510] 1x Membrane for inoculation port or manual bypass sampler (package of 10 pieces) [BBI-43830001] 1x Flat seal for Pg 13.5 (package of 5 pieces) [BBI-44130214] 1x Flat seal for 12 mm ports (Package of 5 pieces) [BBI-44130210] 1x Gasket TC25 for hose connector exhaust cooler (package of 5 pieces) [BBI-45100302] 1x O-ring for items to install in 11 mm ports (package of 10 pieces) [BBI-45100011] 1x O-ring for items to install in M 26 x 1 ports (package of 10 pieces) [BBI-45100015] 1x O-ring for adapter (package of 5 pieces) [BBI-45100025] 1x Silicone grease, 5 ml [BBI-44130901] 1x Stainless steel fitting grease, 5 ml [BBI-44130902] 1x Clamping cone (Package of 5 pieces) [BBI-44130017] 1x O-ring for inoculation port cap (package of 5 pieces) [BBI-45100026] 1x Circlip for dip tube for harvesting, height-adjustable (package of 10 pieces) [BBI-45110302]
Related Products	Wear parts set for 10 L vessels xCUBIO (BBI-45110606) Wear parts set for 2 L vessels xCUBIO (BBI-45110604) Wear parts set for 5 L vessels xCUBIO (BBI-45110605)

Description:

This complete wear parts set contains all components such as o-rings, seals and filters that should be replaced regularly. Your benefits with the wear parts set:

- Suitable for 1 L glass vessels and fittings
- No time-consuming search of articles
- No tedious price inquiries
- No long delivery times
- Lower total price compared to the individual parts



Alle / Verkaufsartikel / Accessories / Assembly accessories / Consumable sets

Wear parts set for 2 L vessels xCUBIO



bbi Scancode	BBI-45110604
Manufacturer	bbi-biotech GmbH
Material Certificate	FDA
Country of Origin	DE 

Components	<p>1x 2 L O-ring [BBI-45100022] 1x O-ring for stirrer shaft [BBI-45100018] 1x Sterile filter gas 50 mm [BBI-44130511] 1x Sterile filter 30 mm 0.2 µm (package of 10 pieces) [BBI-44130510] 1x Membrane for inoculation port or manual bypass sampler (package of 10 pieces) [BBI-43830001] 1x Flat seal for Pg 13.5 (package of 5 pieces) [BBI-44130214] 1x Flat seal for 12 mm ports (Package of 5 pieces) [BBI-44130210] 1x Gasket TC25 for hose connector exhaust cooler (package of 5 pieces) [BBI-45100302] 1x O-ring for items to install in 11 mm ports (package of 10 pieces) [BBI-45100011] 1x O-ring for items to install in M 26 x 1 ports (package of 10 pieces) [BBI-45100015] 1x O-ring for adapter (package of 5 pieces) [BBI-45100025] 1x Silicone grease, 5 ml [BBI-44130901] 1x Stainless steel fitting grease, 5 ml [BBI-44130902] 1x Clamping cone (Package of 5 pieces) [BBI-44130017] 1x O-ring for inoculation port cap (package of 5 pieces) [BBI-45100026] 1x Circlip for dip tube for harvesting, height-adjustable (package of 10 pieces) [BBI-45110302]</p>
Related Products	<p>Wear parts set for 1 L vessels xCUBIO (BBI-45110603) Wear parts set for 10 L vessels xCUBIO (BBI-45110606) Wear parts set for 5 L vessels xCUBIO (BBI-45110605)</p>

Description:

This complete wear parts set contains all components such as o-rings, seals and filters that should be replaced regularly. Your benefits with the wear parts set:

- Suitable for 2 L glass vessels and fittings
- No time-consuming search of articles
- No tedious price inquiries
- No long delivery times
- Lower total price compared to the individual parts



Alle / Verkaufsartikel / Accessories / Assembly accessories / Consumable sets

Wear parts set for 5 L vessels xCUBIO



bbi Scancode	BBI-45110605
Manufacturer	bbi-biotech GmbH
Material Certificate	FDA
Country of Origin	DE 

Components	<p>1x 5 L O-ring [BBI-45100023] 1x O-ring for stirrer shaft [BBI-45100018] 1x Sterile filter gas 50 mm [BBI-44130511] 1x Sterile filter 30 mm 0.2 µm (package of 10 pieces) [BBI-44130510] 1x Membrane for inoculation port or manual bypass sampler (package of 10 pieces) [BBI-43830001] 1x Flat seal for Pg 13.5 (package of 5 pieces) [BBI-44130214] 1x Flat seal for 12 mm ports (Package of 5 pieces) [BBI-44130210] 1x Gasket TC25 for hose connector exhaust cooler (package of 5 pieces) [BBI-45100302] 1x O-ring for items to install in 11 mm ports (package of 10 pieces) [BBI-45100011] 1x O-ring for items to install in M 26 x 1 ports (package of 10 pieces) [BBI-45100015] 1x O-ring for adapter (package of 5 pieces) [BBI-45100025] 1x Silicone grease, 5 ml [BBI-44130901] 1x Stainless steel fitting grease, 5 ml [BBI-44130902] 1x Clamping cone (Package of 5 pieces) [BBI-44130017] 1x O-ring for inoculation port cap (package of 5 pieces) [BBI-45100026] 1x Circlip for dip tube for harvesting, height-adjustable (package of 10 pieces) [BBI-45110302]</p>
Related Products	<p>Sterile filter gas 50 mm (BBI-44130511) Wear parts set for 1 L vessels xCUBIO (BBI-45110603) Wear parts set for 2 L vessels xCUBIO (BBI-45110604)</p>

Description:

This complete wear parts set contains all components such as o-rings, seals and filters that should be replaced regularly. Your benefits with the wear parts set:

- Suitable for 5 L glass vessels and fittings
- No time-consuming search of articles
- No tedious price inquiries
- No long delivery times
- Lower total price compared to the individual parts



Alle / Verkaufsartikel / Accessories / Assembly accessories / Consumable sets

Wear parts set for 10 L vessels xCUBIO



bbi Scancode	BBI-45110606
Manufacturer	bbi-biotech GmbH
Material Certificate	FDA
Country of Origin	DE 

Components	<p>1x 10 L O-ring [BBI-45100024] 1x O-ring for stirrer shaft [BBI-45100018] 1x Sterile filter gas 50 mm [BBI-44130511] 1x Sterile filter 30 mm 0.2 µm (package of 10 pieces) [BBI-44130510] 1x Membrane for inoculation port or manual bypass sampler (package of 10 pieces) [BBI-43830001] 1x Flat seal for Pg 13.5 (package of 5 pieces) [BBI-44130214] 1x Flat seal for 12 mm ports (Package of 5 pieces) [BBI-44130210] 1x Gasket TC25 for hose connector exhaust cooler (package of 5 pieces) [BBI-45100302] 1x O-ring for items to install in 11 mm ports (package of 10 pieces) [BBI-45100011] 1x O-ring for items to install in M 26 x 1 ports (package of 10 pieces) [BBI-45100015] 1x O-ring for adapter (package of 5 pieces) [BBI-45100025] 1x Silicone grease, 5 ml [BBI-44130901] 1x Stainless steel fitting grease, 5 ml [BBI-44130902] 1x Clamping cone (Package of 5 pieces) [BBI-44130017] 1x O-ring for inoculation port cap (package of 5 pieces) [BBI-45100026] 1x Circlip for dip tube for harvesting, height-adjustable (package of 10 pieces) [BBI-45110302]</p>
Related Products	<p>Wear parts set for 1 L vessels xCUBIO (BBI-45110603) Wear parts set for 2 L vessels xCUBIO (BBI-45110604) Wear parts set for 5 L vessels xCUBIO (BBI-45110605)</p>

Description:

This complete wear parts set contains all components such as o-rings, seals and filters that should be replaced regularly. Your benefits with the wear parts set:

- Suitable for 10 L glass vessels and fittings
- No time-consuming search of articles
- No tedious price inquiries
- No long delivery times
- Lower total price compared to the individual parts



Alle / Verkaufsartikel / Accessories / Sampling

Sterile addition unit AP19



bbi Scancode	BBI-43630300
Manufacturer	bbi-biotech GmbH
Internal Thread	G 1 1/4
Material Certificate	3.1, Rauigkeit, FDA
Country of Origin	DE 
HS-Code	84818073
Weight	0.92 kg
Material	Stainless steel 316L EPDM black

Consumables	O-ring 12.37 x 2.62 (BBI-45100012)
Related Products	Sterile addition unit AP25 (BBI-43630301)
<p>Description:</p> <ul style="list-style-type: none"> • For the addition of fluid / medium to the sterile bioreactor / fermenter • With triclamp mm • Manual handling, automation optional 	



Alle / Verkaufsartikel / Accessories / Sampling

Sterile addition unit AP25



bbi Scancode	BBI-43630301
Manufacturer	bbi-biotech GmbH
Internal Thread	G 1 1/4
Material Certificate	3.1, Rauigkeit, FDA
Country of Origin	DE 
HS-Code	84818073
Material	Stainless steel 316L EPDM black

Related Products	Sterile addition unit AP19 (BBI-43630300)
Description:	
<ul style="list-style-type: none"> • For the addition of fluid / medium to the sterile bioreactor / fermenter • With triclamp mm • Manual handling, automation optional 	



To the Shop:



Alle / Verkaufsartikel / Accessories / Sampling / Manual Sampling

Manual bypass sampler



bbi Scancode	BBI-43830000
Manufacturer	bbi-biotech GmbH
Material Certificate	3.1, Rauigkeit, FDA
Country of Origin	DE 
HS-Code	73269098
Weight	0.03 kg
Material	Stainless steel 316L EPDM black silicone

Components	1x bypass-sampler; 1x safety cap; 1x membrane [BBI-43830001]; 1x o-ring [BBI-45100026]
Consumables	O-ring 10.82 x 1.78 (package of 10 pieces) (BBI-45100019) Membrane/septa for inoculation port or manual bypass sampler (package of 10 pieces) (BBI-43830001)
Related Products	Manual sampler (classical) (BBI-43830002) Membrane/septa for inoculation port or manual bypass sampler (latex) (package of 10 pieces) (BBI-43830007) Membrane/septa for inoculation port or manual bypass sampler (package of 10 pieces) (BBI-43830001)

Description:

- Used for manual sampling in bypass
- Used with inoculation needles and cannulas
- With inoculation port and safety cap
- A membrane is pinched with a cannula in order to draw a sterile sampling
- It is possible to use the bypass sampler as a bypass addition port



To the Shop:



Alle / Verkaufsartikel / Accessories / Sampling / Manual Sampling

Manual sampler (classical)



bbi Scancode	BBI-43830002
Manufacturer	bbi-biotech GmbH
Internal Thread	GL 25
External Thread	GL 25
Material Certificate	3.1, Rauigkeit, FDA
Country of Origin	DE 
HS-Code	82073010
Weight	0.3 kg
Material	Stainless steel 316L silicone borosilicate glass PBT

Components	1x glass vessel [BBI-43830004]; 1x headpiece [BBI-43830005]; 1x seal [BBI-44130455]; 1x screw cap [BBI-44130456]; 1x filter [BBI-44130510]; 1x hose clamp [BBI-43830104]; 1x holder; 1x silicone tube [e.g.: BBI-44130602]; 1x silicone tube [e.g.: BBI-44130601]; 1x syringe
Consumables	Seal for screw cap GL 25 (package of 10 pieces) (BBI-44130455) Sterile filter 30 mm 0.2 µm (package of 10 pieces) (BBI-44130510) Silicone tube 3.2 x 1.6 mm (package with 5 m) (BBI-44130605) Silicone tube 1.6 x 1.6 mm (package with 5 m) (BBI-44130604) Hose clamp stainless steel (package of 10 pieces) (BBI-43830104)
Related Products	Headpiece for manual sampler (classical) (BBI-43830005) Manual sampler (disposable version) (BBI-43830006) Sampling tube for manual sampler (classical) (BBI-43830004)

Description:

- For sampling from bioreactor vessels
- For samples up to 15 ml
- 3 hose nozzles in headplate for hose from culture vessel, for sample outlet and for the syringe
- Sterile filter at the tip prevents unsterile air from entering into the culture vessel while sucking or pushing the sample
- With holder for mounting on vessel stand
- bbi-biotech also offers a disposable version!



To the Shop:



Alle / Verkaufsartikel / Accessories / Sampling / Manual Sampling

Sampling tube for manual sampler (classical)



bbi Scancode	BBI-43830004
Manufacturer	bbi-biotech GmbH
External Thread	GL 25
Country of Origin	DE 
HS-Code	70179000
Weight	1.2 kg
Material	borosilicate glass

Components	1x glass vessel
Related Products	Headpiece for manual sampler (classical) (BBI-43830005) Manual sampler (classical) (BBI-43830002) Screw cap GL 25 with hole (for manual sampler) (BBI-44130456)
Description: <ul style="list-style-type: none"> • Spare part for sampling from the culture vessel • Part of manual sampler (classical) • With thread GL25 • For samples up to 15ml 	



To the Shop:



Alle / Verkaufsartikel / Accessories / Sampling / Manual Sampling

Manual sampler (disposable version)



bbi Scancode	BBI-43830006
Manufacturer	bbi-biotech GmbH
Country of Origin	DE 
HS-Code	39174000
Weight	0.07 kg

Components	1x manual sampler; 2x syringes; 1x filter; 1x hose clamp
Consumables	Luer-lock-adapter male for 4 mm tubing (package of 20 pieces) (BBI-45110205) Silicone tube 3.2 x 1.6 mm (package with 5 m) (BBI-44130605) Sterile filter 30 mm 0.2 µm (package of 10 pieces) (BBI-44130510)
Related Products	4-way addition port M 26 x 1 (BBI-43630202) Manual bypass sampler (BBI-43830000) Manual sampler (classical) (BBI-43830002)

Description:

- For sampling from the culture vessel
- For samples up to 20 ml (depends on size of connected sample syringe)
- The sampler will be connected to the dip tube of the bioreactor
- A contamination of the medium is impossible within the vessel, since once the sample was taken, it can not be pushed back due to the built-in check valve
- The system can be autoclaved
- Similar to pictures shown



To the Shop:



Alle / Verkaufsartikel / Accessories / Sampling / Sampling valves

Sampling Valve SPN25, manual



bbi Scancode	BBI-43830200
Manufacturer	bbi-biotech GmbH
Internal Thread	G 1 1/4
Material Certificate	3.1, Rauigkeit, FDA
Country of Origin	DE 
HS-Code	73269098
Weight	0.88 kg
Material	Stainless steel 316L EPDM black

Components	1x sampling valve, 1x membrane [BBI-45100101], 1x o-ring [BBI-45100010], 1x o-ring [BBI-45100014]
Consumables	O-ring 5.23 x 2.62 (BBI-45100010) O-ring for items to install in 25 mm Ingold ports (package of 10 pieces) (BBI-45100014)
Related Products	Membrane for sampling valve or AP19 (BBI-45100101) Sampling Valve SPN25 automated (standard) (BBI-43830202) Sampling valve 37 mm (manual) (BBI-43830201)

Description:

- For production-scale bioreactors
- For samples with solids up to 5 mm
- Aerosol-free
- leaning with steam or cleaning fluids
- Optimized connection for steam
- Cooling between sampling possible to shorten time between samples
- Available as automated version
- Triclamp connection 25 mm
- Installation in 52 mm Ingold port
- With membrane [BBI-45100101]



To the Shop:



Alle / Verkaufsartikel / Accessories / Sampling / Sampling valves

Sampling valve 37 mm (manual)



bbi Scancode	BBI-43830201
Manufacturer	bbi-biotech GmbH
Internal Thread	G 1 1/4
Material Certificate	3.1, Rauigkeit, FDA
Material	Stainless steel 316L EPDM black

Components	1x sampling valve, 1x membrane [BBI-45100101], 1x o-ring [BBI-45100010], 1x o-ring [BBI-45100014]
Related Products	Membrane for sampling valve or AP19 (BBI-45100101) Sampling Valve SPN25 automated (standard) (BBI-43830202) Sampling Valve SPN25, manual (BBI-43830200)

Description:

- For production-scale bioreactors
- For samples with solids up to 5 mm
- Aerosol-free
- leaning with steam or cleaning fluids
- Optimized connection for steam
- Cooling between sampling possible to shorten time between samples
- Available as automated version
- Triclamp connection 25 mm
- Installation in 37 mm Ingold port
- With membrane [BBI-45100101]



Alle / Verkaufsartikel / Accessories / Sampling / Sampling valves

Sampling Valve SPN25 automated (standard)



bbi Scancode	BBI-43830202
Manufacturer	bbi-biotech GmbH
Internal Thread	G 1 1/4
Material Certificate	3.1, Rauigkeit, FDA
HS-Code	0
Material	Stainless steel 316L EPDM black

Components	
Related Products	Membrane for sampling valve or AP19 (BBI-45100101) Sampling Valve SPN25, manual (BBI-43830200) Sampling valve 37 mm (manual) (BBI-43830201)
Description: <ul style="list-style-type: none"> • For production-scale bioreactors • For samples with solids up to 5 mm • Aerosol-free •leaning with steam or cleaning fluids • Optimized connection for steam • Cooling between sampling possible to shorten time between samples • Triclamp connection 25 mm • Installation in 52 mm Ingold port • With membrane [BBI-45100101] 	



Alle / Verkaufsartikel / Accessories / Stirring and mixing / 3-bladed segment impellers

3-blade segment impeller, Ø 130 mm, 18 mm stirrer shaft



bbi Scancode	BBI-43230013
Manufacturer	bbi-biotech GmbH
Material Certificate	3.1, Rauigkeit
Country of Origin	DE 
HS-Code	84798200
Material	Stainless steel 316L

Components	1x impeller, 5x grub screw
Consumables	Grub screw for blades of 3-bladed-segment impeller & 2-bladed paddle impeller for mounting on the stirrer shaft (package of 10 pieces) (BBI-45110503) Grub screw for 3-bladed-segment impeller & 2-bladed paddle impeller for mounting on the stirrer shaft (package of 10 pieces) (BBI-45110504)
Related Products	3-blade segment impeller, Ø 130 mm, 14 mm stirrer shaft (BBI-43230021) 3-blade segment impeller, Ø 78 mm, 16 mm stirrer shaft (BBI-43230014) 3-blade segment impeller, Ø 95 mm, 18 mm stirrer shaft (BBI-43230023)

Description:

- Used for stirring in bioreactors
- For shafts with diameter of 18 mm
- Suitable for shear-sensitive cells
- Suitable for microcarriers
- Prevents sedimentation
- Even at low speeds, thorough mixing
- Ideal flow for spinfilters
- When used in combination with an aeration basket the medium is circulated in a vertical loop.
- Adjustable angles of segments
- Ø 130 mm



To the Shop:



Alle / Verkaufsartikel / Accessories / Stirring and mixing / 3-bladed segment impellers

3-blade segment impeller, Ø 78 mm, 16 mm stirrer shaft



bbi Scancode	BBI-43230014
Manufacturer	bbi-biotech GmbH
Material Certificate	3.1, Rauigkeit
Country of Origin	DE 
HS-Code	84798200
Material	Stainless steel 316L

Components	1x impeller, 5x grub screw
Related Products	3-blade segment impeller, Ø 109 mm, 16 mm stirrer shaft (BBI-43230022) 3-blade segment impeller, Ø 300 mm, 16 mm stirrer shaft (BBI-43230018) 6-bladed impeller, Ø 74 mm, 16 mm stirrer shaft (BBI-43230008)

Description:

- Used for stirring in bioreactors
- For shafts with diameter of 16 mm
- Suitable for shear-sensitive cells
- Suitable for microcarriers
- Prevents sedimentation
- Even at low speeds, thorough mixing
- Ideal flow for spinfilters
- When used in combination with an aeration basket the medium is circulated in a vertical loop.
- Adjustable angles of segments
- Ø 78 mm



To the Shop:



Alle / Verkaufsartikel / Accessories / Stirring and mixing / 3-bladed segment impellers

3-blade segment impeller, Ø 70 mm, 14 mm stirrer shaft



bbi Scancode	BBI-43230015
Manufacturer	bbi-biotech GmbH
Material Certificate	3.1, Rauigkeit
Country of Origin	DE 
HS-Code	84798200
Material	Stainless steel 316L

Components	1x impeller, 5x grub screw
Related Products	2-bladed paddle impeller, Ø 109 mm, 14 mm stirrer shaft (BBI-43230053) 3-blade segment impeller, Ø 130 mm, 14 mm stirrer shaft (BBI-43230021) 6-bladed impeller, Ø 64 mm, 14 mm stirrer shaft (BBI-43230011)

Description:

- Used for stirring in bioreactors
- For shafts with diameter of 14 mm
- Suitable for shear-sensitive cells
- Suitable for microcarriers
- Prevents sedimentation
- Even at low speeds, thorough mixing
- Ideal flow for spinfilters
- When used in combination with an aeration basket the medium is circulated in a vertical loop.
- Adjustable angles of segments
- Ø 70 mm



Alle / Verkaufsartikel / Accessories / Stirring and mixing / 3-bladed segment impellers

3-blade segment impeller, Ø 48 mm, 10 mm stirrer shaft



bbi Scancode	BBI-43230016
Manufacturer	bbi-biotech GmbH
Material Certificate	3.1, Rauigkeit
Country of Origin	DE 
HS-Code	84798200
Weight	0.11 kg
Material	Stainless steel 316L

Components	1x impeller, 5x grub screw
Related Products	3-blade segment impeller, Ø 54 mm, 10 mm stirrer shaft (BBI-43230025) 3-blade segment impeller, Ø 58 mm, 10 mm stirrer shaft (BBI-43230026) 3-blade segment impeller, Ø 90 mm, 10 mm stirrer shaft (BBI-43230027)

Description:

- Used for stirring in bioreactors
- For shafts with diameter of 10 mm
- Suitable for shear-sensitive cells
- Suitable for microcarriers
- Prevents sedimentation
- Even at low speeds, thorough mixing
- Ideal flow for spinfilters
- When used in combination with an aeration basket the medium is circulated in a vertical loop.
- Adjustable angles of segments
- Ø 48 mm



To the Shop:



Alle / Verkaufsartikel / Accessories / Stirring and mixing / 3-bladed segment impellers

3-blade segment impeller, Ø 300 mm, 16 mm stirrer shaft



bbi Scancode	BBI-43230018
Manufacturer	bbi-biotech GmbH
Material Certificate	3.1, Rauigkeit
Country of Origin	DE 
HS-Code	84798200
Material	Stainless steel 316L

Components	1x impeller, 5x grub screw
Related Products	<p>3-blade segment impeller, Ø 109 mm, 16 mm stirrer shaft (BBI-43230022)</p> <p>3-blade segment impeller, Ø 150 mm, 10 mm stirrer shaft (BBI-43230029)</p> <p>3-blade segment impeller, Ø 78 mm, 16 mm stirrer shaft (BBI-43230014)</p>

Description:

- Used for stirring in bioreactors
- For shafts with diameter of 16 mm
- Suitable for shear-sensitive cells
- Suitable for microcarriers
- Prevents sedimentation
- Even at low speeds, thorough mixing
- Ideal flow for spinfilters
- When used in combination with an aeration basket the medium is circulated in a vertical loop.
- Adjustable angles of segments
- Ø 300 mm



To the Shop:



Alle / Verkaufsartikel / Accessories / Stirring and mixing / 3-bladed segment impellers

3-blade segment impeller, Ø 56 mm, 10 mm stirrer shaft



bbi Scancode	BBI-43230020
Manufacturer	bbi-biotech GmbH
Material Certificate	3.1, Rauigkeit
Country of Origin	DE 
HS-Code	84798200
Material	Stainless steel 316L

Components	1x impeller, 5x grub screw
Related Products	2-bladed paddle impeller, Ø 54 mm, 10 mm stirrer shaft (BBI-43230050) 3-blade segment impeller, Ø 48 mm, 10 mm stirrer shaft (BBI-43230016) Chemineer P3, Ø 56mm, 10 mm stirrer shaft (BBI-43230080)

Description:

- Used for stirring in bioreactors
- For shafts with diameter of 10 mm
- Suitable for shear-sensitive cells
- Suitable for microcarriers
- Prevents sedimentation
- Even at low speeds, thorough mixing
- Ideal flow for spinfilters
- When used in combination with an aeration basket the medium is circulated in a vertical loop.
- Adjustable angles of segments
- Ø 56 mm



To the Shop:



Alle / Verkaufsartikel / Accessories / Stirring and mixing / 3-bladed segment impellers

3-blade segment impeller, Ø 130 mm, 14 mm stirrer shaft



bbi Scancode	BBI-43230021
Manufacturer	bbi-biotech GmbH
Material Certificate	3.1, Rauigkeit
Country of Origin	DE 
HS-Code	84798200
Material	Stainless steel 316L

Components	1x impeller, 5x grub screw
Consumables	Grub screw for blades of 3-bladed-segment impeller & 2-bladed paddle impeller for mounting on the stirrer shaft (package of 10 pieces) (BBI-45110503)
Related Products	3-blade segment impeller, Ø 130 mm, 18 mm stirrer shaft (BBI-43230013) 3-blade segment impeller, Ø 70 mm, 14 mm stirrer shaft (BBI-43230015) 3-blade segment impeller, Ø 95 mm, 18 mm stirrer shaft (BBI-43230023)

Description:

- Used for stirring in bioreactors
- For shafts with diameter of 14 mm
- Suitable for shear-sensitive cells
- Suitable for microcarriers
- Prevents sedimentation
- Even at low speeds, thorough mixing
- Ideal flow for spinfilters
- When used in combination with an aeration basket the medium is circulated in a vertical loop.
- Adjustable angles of segments
- Ø 130 mm



Alle / Verkaufsartikel / Accessories / Stirring and mixing / 3-bladed segment impellers

3-blade segment impeller, Ø 109 mm, 16 mm stirrer shaft



bbi Scancode	BBI-43230022
Manufacturer	bbi-biotech GmbH
Material Certificate	3.1, Rauigkeit
Country of Origin	DE 
HS-Code	84798200
Material	Stainless steel 316L

Components	1x impeller, 5x grub screw
Related Products	<p>3-blade segment impeller, Ø 300 mm, 16 mm stirrer shaft (BBI-43230018)</p> <p>3-blade segment impeller, Ø 78 mm, 16 mm stirrer shaft (BBI-43230014)</p> <p>3-blade segment impeller, Ø 95 mm, 18 mm stirrer shaft (BBI-43230023)</p>

Description:

- Used for stirring in bioreactors
- For shafts with diameter of 16 mm
- Suitable for shear-sensitive cells
- Suitable for microcarriers
- Prevents sedimentation
- Even at low speeds, thorough mixing
- Ideal flow for spinfilters
- When used in combination with an aeration basket the medium is circulated in a vertical loop.
- Adjustable angles of segments
- Ø 109 mm



Alle / Verkaufsartikel / Accessories / Stirring and mixing / 3-bladed segment impellers

3-blade segment impeller, Ø 95 mm, 18 mm stirrer shaft



bbi Scancode	BBI-43230023
Manufacturer	bbi-biotech GmbH
Material Certificate	3.1, Rauigkeit
Country of Origin	DE 
HS-Code	84798200
Material	Stainless steel 316L

Components	1x impeller, 5x grub screw
Related Products	2-bladed paddle impeller, Ø 135 mm, 18 mm stirrer shaft (BBI-43230055) 3-blade segment impeller, Ø 130 mm, 18 mm stirrer shaft (BBI-43230013) 6-bladed impeller, Ø 104 mm, 18 mm stirrer shaft (BBI-43230010)

Description:

- Used for stirring in bioreactors
- For shafts with diameter of 18 mm
- Suitable for shear-sensitive cells
- Suitable for microcarriers
- Prevents sedimentation
- Even at low speeds, thorough mixing
- Ideal flow for spinfilters
- When used in combination with an aeration basket the medium is circulated in a vertical loop.
- Adjustable angles of segments
- Ø 95 mm



To the Shop:



Alle / Verkaufsartikel / Accessories / Stirring and mixing / 3-bladed segment impellers

3-blade segment impeller, Ø 37 mm, 6 mm stirrer shaft



bbi Scancode	BBI-43230024
Manufacturer	bbi-biotech GmbH
Material Certificate	3.1, Rauigkeit
Country of Origin	DE 
HS-Code	84798200
Weight	0.01 kg
Material	Stainless steel 316L

Components	1x impeller, 5x grub screw
Related Products	<p>0.5 L 3-bladed-segment impeller (BBI-43230302)</p> <p>3-blade segment impeller, Ø 48 mm, 10 mm stirrer shaft (BBI-43230016)</p> <p>3-blade segment impeller, Ø 78 mm, 16 mm stirrer shaft (BBI-43230014)</p>

Description:

- Used for stirring in bioreactors
- For shafts with diameter of 6 mm
- Suitable for shear-sensitive cells
- Suitable for microcarriers
- Prevents sedimentation
- Even at low speeds, thorough mixing
- Ideal flow for spinfilters
- When used in combination with an aeration basket the medium is circulated in a vertical loop.
- Adjustable angles of segments
- Ø 37 mm



To the Shop:



Alle / Verkaufsartikel / Accessories / Stirring and mixing / 3-bladed segment impellers

3-blade segment impeller, Ø 54 mm, 10 mm stirrer shaft



bbi Scancode	BBI-43230025
Manufacturer	bbi-biotech GmbH
Material Certificate	3.1, Rauigkeit
Country of Origin	DE 
HS-Code	84798200
Weight	0.05 kg
Material	Stainless steel 316L

Components	1x impeller, 5x grub screw
Related Products	2-bladed paddle impeller, Ø 54 mm, 10 mm stirrer shaft (BBI-43230050) 3-blade segment impeller, Ø 48 mm, 10 mm stirrer shaft (BBI-43230016) CT6-stirrer; Ø 53mm, 10 mm stirrer shaft (BBI-43230070)

Description:

- Used for stirring in bioreactors
- For shafts with diameter of 6 mm
- Suitable for shear-sensitive cells
- Suitable for microcarriers
- Prevents sedimentation
- Even at low speeds, thorough mixing
- Ideal flow for spinfilters
- When used in combination with an aeration basket the medium is circulated in a vertical loop.
- Adjustable angles of segments
- Ø 54 mm



To the Shop:



Alle / Verkaufsartikel / Accessories / Stirring and mixing / 3-bladed segment impellers

3-blade segment impeller, Ø 58 mm, 10 mm stirrer shaft



bbi Scancode	BBI-43230026
Manufacturer	bbi-biotech GmbH
Material Certificate	3.1, Rauigkeit
Country of Origin	DE 
HS-Code	84798200
Material	Stainless steel 316L

Components	1x impeller, 5x grub screw
Consumables	Grub screw for blades of 3-bladed-segment impeller & 2-bladed paddle impeller for mounting on the stirrer shaft (package of 10 pieces) (BBI-45110503) Grub screw for 3-bladed-segment impeller & 2-bladed paddle impeller for mounting on the stirrer shaft (package of 10 pieces) (BBI-45110504)
Related Products	2-bladed paddle impeller, Ø 54 mm, 10 mm stirrer shaft (BBI-43230050) 3-blade segment impeller, Ø 48 mm, 10 mm stirrer shaft (BBI-43230016) Chemineer P3, Ø 56mm, 10 mm stirrer shaft (BBI-43230080)

Description:

- Used for stirring in bioreactors
- For shafts with diameter of 6 mm
- Suitable for shear-sensitive cells
- Suitable for microcarriers
- Prevents sedimentation
- Even at low speeds, thorough mixing
- Ideal flow for spinfilters
- When used in combination with an aeration basket the medium is circulated in a vertical loop.
- Adjustable angles of segments
- Ø 58 mm



To the Shop:



Alle / Verkaufsartikel / Accessories / Stirring and mixing / 3-bladed segment impellers

3-blade segment impeller, Ø 90 mm, 10 mm stirrer shaft



bbi Scancode	BBI-43230027
Manufacturer	bbi-biotech GmbH
Material Certificate	3.1, Rauigkeit
Country of Origin	DE 
HS-Code	84798200
Material	Stainless steel 316L

Components	1x impeller, 5x grub screw
Related Products	<p>3-blade segment impeller, Ø 123 mm, 10 mm stirrer shaft (BBI-43230028)</p> <p>3-blade segment impeller, Ø 150 mm, 10 mm stirrer shaft (BBI-43230029)</p> <p>3-blade segment impeller, Ø 58 mm, 10 mm stirrer shaft (BBI-43230026)</p>

Description:

- Used for stirring in bioreactors
- For shafts with diameter of 6 mm
- Suitable for shear-sensitive cells
- Suitable for microcarriers
- Prevents sedimentation
- Even at low speeds, thorough mixing
- Ideal flow for spinfilters
- When used in combination with an aeration basket the medium is circulated in a vertical loop.
- Adjustable angles of segments
- Ø 90 mm



Alle / Verkaufsartikel / Accessories / Stirring and mixing / 3-bladed segment impellers

3-blade segment impeller, Ø 123 mm, 10 mm stirrer shaft



bbi Scancode	BBI-43230028
Manufacturer	bbi-biotech GmbH
Material Certificate	3.1, Rauigkeit
Country of Origin	DE 
HS-Code	84798200
Material	Stainless steel 316L

Components	1x impeller, 5x grub screw
Related Products	<p>3-blade segment impeller, Ø 150 mm, 10 mm stirrer shaft (BBI-43230029)</p> <p>3-blade segment impeller, Ø 48 mm, 10 mm stirrer shaft (BBI-43230016)</p> <p>3-blade segment impeller, Ø 58 mm, 10 mm stirrer shaft (BBI-43230026)</p>

Description:

- Used for stirring in bioreactors
- For shafts with diameter of 6 mm
- Suitable for shear-sensitive cells
- Suitable for microcarriers
- Prevents sedimentation
- Even at low speeds, thorough mixing
- Ideal flow for spinfilters
- When used in combination with an aeration basket the medium is circulated in a vertical loop.
- Adjustable angles of segments
- Ø 123 mm



Alle / Verkaufsartikel / Accessories / Stirring and mixing / 3-bladed segment impellers

3-blade segment impeller, Ø 150 mm, 10 mm stirrer shaft



bbi Scancode	BBI-43230029
Manufacturer	bbi-biotech GmbH
Material Certificate	3.1, Rauigkeit
Country of Origin	DE 
HS-Code	84798200
Material	Stainless steel 316L

Components	1x impeller, 5x grub screw
Related Products	<p>3-blade segment impeller, Ø 123 mm, 10 mm stirrer shaft (BBI-43230028)</p> <p>3-blade segment impeller, Ø 70 mm, 14 mm stirrer shaft (BBI-43230015)</p> <p>3-blade segment impeller, Ø 90 mm, 10 mm stirrer shaft (BBI-43230027)</p>

Description:

- Used for stirring in bioreactors
- For shafts with diameter of 6 mm
- Suitable for shear-sensitive cells
- Suitable for microcarriers
- Prevents sedimentation
- Even at low speeds, thorough mixing
- Ideal flow for spinfilters
- When used in combination with an aeration basket the medium is circulated in a vertical loop.
- Adjustable angles of segments
- Ø 150 mm



Alle / Verkaufsartikel / Accessories / Stirring and mixing / 3-bladed segment impellers

0.25 L 3-bladed-segment impeller



bbi Scancode	BBI-43230301
Manufacturer	bbi-biotech GmbH
Material Certificate	3.1, Rauigkeit
Country of Origin	DE 
HS-Code	84798200
Weight	0.01 kg
Material	Stainless steel 316L

Components	1x stirrer, 5x grub screw
Related Products	<p>0.25 L Rushton impeller (BBI-43230321)</p> <p>0.25 L jacketed glass vessel (BBI-44430054)</p> <p>0.25 L stirrer shaft, 6 mm (BBI-43230047)</p>

Description:

- Used for stirring in bioreactors
- Suitable for shear-sensitive cells
- Suitable for microcarriers
- Prevents sedimentation
- Even at low speeds thorough mixing
- Ideal flow for spinfilters
- When used in combination with an aeration basket the medium is circulated in a vertical loop
- Adjustable angle
- Ø 26 mm, for 6 mm shaft
- Spare part for bioreactors



To the Shop:



Alle / Verkaufsartikel / Accessories / Stirring and mixing / 3-bladed segment impellers

0.5 L 3-bladed-segment impeller



bbi Scancode	BBI-43230302
Manufacturer	bbi-biotech GmbH
Material Certificate	3.1, Rauigkeit
Country of Origin	DE 
HS-Code	84798200
Weight	0.03 kg
Material	Stainless steel 316L

Components	1x stirrer, 5x grub screw
Consumables	Grub screw for blades of 3-bladed-segment impeller & 2-bladed paddle impeller for mounting on the stirrer shaft (package of 10 pieces) (BBI-45110503) Grub screw for 3-bladed-segment impeller & 2-bladed paddle impeller for mounting on the stirrer shaft (package of 10 pieces) (BBI-45110504)
Related Products	0.5 L 2-bladed paddle impeller (BBI-43230312) 0.5 L Rushton impeller (BBI-43230322) 0.5 L stirrer shaft, 8 mm (BBI-43230042)

Description:

- Used for stirring in bioreactors
- Suitable for shear-sensitive cells
- Suitable for microcarriers
- Prevents sedimentation
- Even at low speeds thorough mixing
- Ideal flow for spinfilters
- When used in combination with an aeration basket the medium is circulated in a vertical loop
- Adjustable angle
- Ø 36 mm, for 8 mm shaft
- Spare part for bioreactors



To the Shop:



Alle / Verkaufsartikel / Accessories / Stirring and mixing / 3-bladed segment impellers

1 L 3-bladed-segment impeller



bbi Scancode	BBI-43230303
Manufacturer	bbi-biotech GmbH
Material Certificate	3.1, Rauigkeit
Country of Origin	DE 
HS-Code	84798200
Weight	0.05 kg
Material	Stainless steel 316L

Components	1x stirrer, 5x grub screw
Related Products	<p>1 L 2-bladed paddle impeller (BBI-43230313)</p> <p>1 L Rushton impeller (BBI-43230323)</p> <p>2-bladed paddle impeller, Ø 54 mm, 10 mm stirrer shaft (BBI-43230050)</p>

Description:

- Used for stirring in bioreactors
- Suitable for shear-sensitive cells
- Suitable for microcarriers
- Prevents sedimentation
- Even at low speeds thorough mixing
- Ideal flow for spinfilters
- When used in combination with an aeration basket the medium is circulated in a vertical loop
- Adjustable angle
- Ø 44 mm, for 10 mm shaft
- Spare part for bioreactors



To the Shop:



Alle / Verkaufsartikel / Accessories / Stirring and mixing / 3-bladed segment impellers

2 L 3-bladed-segment impeller



bbi Scancode	BBI-43230304
Manufacturer	bbi-biotech GmbH
Material Certificate	3.1, Rauigkeit
Country of Origin	DE 
HS-Code	84798200
Weight	0.05 kg
Material	Stainless steel 316L

Components	1x stirrer, 5x grub screw
Consumables	Grub screw for blades of 3-bladed-segment impeller & 2-bladed paddle impeller for mounting on the stirrer shaft (package of 10 pieces) (BBI-45110503) Grub screw for 3-bladed-segment impeller & 2-bladed paddle impeller for mounting on the stirrer shaft (package of 10 pieces) (BBI-45110504)
Related Products	2 L 2-bladed paddle impeller (BBI-43230314) 2 L Rushton impeller (BBI-43230324) 2 L stirrer shaft, 10 mm (BBI-43230041)

Description:

- Used for stirring in bioreactors
- Suitable for shear-sensitive cells
- Suitable for microcarriers
- Prevents sedimentation
- Even at low speeds thorough mixing
- Ideal flow for spinfilters
- When used in combination with an aeration basket the medium is circulated in a vertical loop
- Adjustable angle
- Ø 52 mm, for 10 mm shaft
- Spare part for bioreactors



To the Shop:



Alle / Verkaufsartikel / Accessories / Stirring and mixing / 3-bladed segment impellers

5 L 3-bladed-segment impeller



bbi Scancode	BBI-43230305
Manufacturer	bbi-biotech GmbH
Material Certificate	3.1, Rauigkeit
Country of Origin	DE 
HS-Code	84798200
Weight	0.08 kg
Material	Stainless steel 316L

Components	1x stirrer, 5x grub screw
Consumables	Grub screw for blades of 3-bladed-segment impeller & 2-bladed paddle impeller for mounting on the stirrer shaft (package of 10 pieces) (BBI-45110503) Grub screw for 3-bladed-segment impeller & 2-bladed paddle impeller for mounting on the stirrer shaft (package of 10 pieces) (BBI-45110504)
Related Products	5 L 2-bladed paddle impeller (BBI-43230315) 5 L Rushton impeller (BBI-43230325) 5 L stirrer shaft, 10 mm (BBI-43230046)

Description:

- Used for stirring in bioreactors
- Suitable for shear-sensitive cells
- Suitable for microcarriers
- Prevents sedimentation
- Even at low speeds thorough mixing
- Ideal flow for spinfilters
- When used in combination with an aeration basket the medium is circulated in a vertical loop
- Adjustable angle
- Ø 64 mm, for 10 mm shaft
- Spare part for bioreactors



Alle / Verkaufsartikel / Accessories / Stirring and mixing / 3-bladed segment impellers

10 L 3-bladed-segment impeller



bbi Scancode	BBI-43230306
Manufacturer	bbi-biotech GmbH
Material Certificate	3.1, Rauigkeit
Country of Origin	DE 
HS-Code	84798200
Weight	0.1 kg
Material	Stainless steel 316L

Components	1x stirrer, 5x grub screw
Consumables	Grub screw for blades of 3-bladed-segment impeller & 2-bladed paddle impeller for mounting on the stirrer shaft (package of 10 pieces) (BBI-45110503) Grub screw for 3-bladed-segment impeller & 2-bladed paddle impeller for mounting on the stirrer shaft (package of 10 pieces) (BBI-45110504)

Description:

- Used for stirring in bioreactors
- Suitable for shear-sensitive cells
- Suitable for microcarriers
- Prevents sedimentation
- Even at low speeds thorough mixing
- Ideal flow for spinfilters
- When used in combination with an aeration basket the medium is circulated in a vertical loop
- Adjustable angle
- Ø 76 mm, for 16 mm shaft
- Spare part for bioreactors



Alle / Verkaufsartikel / Accessories / Stirring and mixing / 3-bladed segment impellers

10 L 3-bladed-segment impeller (in-situ)



bbi Scancode	BBI-43230713
Manufacturer	bbi-biotech GmbH
Material Certificate	3.1, Rauigkeit
Country of Origin	DE 
HS-Code	84798200
Material	Stainless steel 316L

Components	1x stirrer
<p>Description:</p> <ul style="list-style-type: none"> • Used for stirring in bioreactors • Suitable for shear-sensitive cells • Suitable for microcarriers • Prevents sedimentation • Even at low speeds thorough mixing • Spare part for bioreactors 	



Alle / Verkaufsartikel / Accessories / Stirring and mixing / 3-bladed segment impellers

20 L 3-bladed-segment impeller



bbi Scancode	BBI-43230714
Manufacturer	bbi-biotech GmbH
Material Certificate	3.1, Rauigkeit
Country of Origin	DE 
HS-Code	84798200
Material	Stainless steel 316L

Components	1x stirrer
Related Products	20 L Rushton impeller (BBI-43230704) 20 L aeration basket (BBI-43530104) 20 L ring sparger, downwards-facing holes (BBI-43530093)
Description: <ul style="list-style-type: none"> • Used for stirring in bioreactors • Suitable for shear-sensitive cells • Suitable for microcarriers • Prevents sedimentation • Even at low speeds thorough mixing • Spare part for bioreactors 	



To the Shop:



Alle / Verkaufsartikel / Accessories / Stirring and mixing / 3-bladed segment impellers

30 L 3-bladed-segment impeller



bbi Scancode	BBI-43230715
Manufacturer	bbi-biotech GmbH
Material Certificate	3.1, Rauigkeit
Country of Origin	DE 
HS-Code	84798200
Material	Stainless steel 316L

Components	1x stirrer
Related Products	30 L Rushton impeller (BBI-43230705)
<p>Description:</p> <ul style="list-style-type: none"> • Used for stirring in bioreactors • Suitable for shear-sensitive cells • Suitable for microcarriers • Prevents sedimentation • Even at low speeds thorough mixing • Spare part for bioreactors 	



To the Shop:



Alle / Verkaufsartikel / Accessories / Stirring and mixing / Condensate storage vessels

Condensate storage tank 250 ml



bbi Scancode	BBI-44435001
Manufacturer	bbi-biotech GmbH
Material Certificate	3.1
Country of Origin	DE 
Weight	1.22 kg
Material	Stainless steel 316L

Components	1x condensate storage tank
Related Products	Condensate storage tank 1.25 L (BBI-44435002)
Description:	



To the Shop:



Alle / Verkaufsartikel / Accessories / Stirring and mixing / Condensate storage vessels

Condensate storage tank 1.25 L



bbi Scancode	BBI-44435002
Manufacturer	bbi-biotech GmbH
Material Certificate	3.1
Country of Origin	DE 
Weight	2.87 kg
Material	Stainless steel 316L

Components	1x condensate storage tank
Related Products	Condensate storage tank 250 ml (BBI-44435001)
Description:	



To the Shop:



Alle / Verkaufsartikel / Accessories / Stirring and mixing / Couplings

Collar for PowerGrip-coupling 21SP



bbi Scancode	BBI-44430401
Manufacturer	bbi-biotech GmbH
Country of Origin	DE 
HS-Code	39269097
Weight	0.01 kg
Material	PU

Components	1x collar
Related Products	Motor 8LVA13 - complete with flange, coupling and collar (BBI-44431002) PowerGrip coupling 14 mm (motor side) (BBI-44430403) PowerGrip coupling for 10 mm stirrer shaft (BBI-44430402)
Description: To connect couplings motor side and stirrer shaft	



To the Shop:



Alle / Verkaufsartikel / Accessories / Stirring and mixing / Couplings

PowerGrip coupling for 10 mm stirrer shaft



bbi Scancode	BBI-44430402
Manufacturer	bbi-biotech GmbH
Country of Origin	DE 
Weight	0.03 kg

Components	1x coupling
Related Products	5 L stirrer shaft, 10 mm (BBI-43230046) Collar for PowerGrip-coupling 21SP (BBI-44430401) PowerGrip coupling 14 mm (motor side) (BBI-44430403)
Description:	



To the Shop:



Alle / Verkaufsartikel / Accessories / Stirring and mixing / Couplings

PowerGrip coupling 14 mm (motor side)



bbi Scancode	BBI-44430403
Manufacturer	bbi-biotech GmbH
Country of Origin	DE 
Weight	0.02 kg

Components	1x coupling
Related Products	1 L stirrer shaft, 10 mm (BBI-43230040) Collar for PowerGrip-coupling 21SP (BBI-44430401) PowerGrip coupling for 10 mm stirrer shaft (BBI-44430402)
Description:	



To the Shop:



Alle / Verkaufsartikel / Accessories / Stirring and mixing / Motor adapters

Motor adapter for Moebius 3 l single-use vessel and 8LVA2X motors (aluminum material)



bbi Scancode	BBI-44431051
Manufacturer	bbi-biotech GmbH
Country of Origin	DE 
Weight	0.37 kg

Components	1x motor adapter, 1x shaft extension
Related Products	Motor adapter (Magnetic drive) for Eppendorf Bioblu 10c and B&R 8LVA2X motors (BBI-44431111)
Description:	



To the Shop:



Alle / Verkaufsartikel / Accessories / Stirring and mixing / Motor adapters

Motor adapter (Magnetic drive) for Eppendorf Bioblu 10c and B&R 8LVA2X motors



bbi Scancode	BBI-44431111
Manufacturer	bbi-biotech GmbH
Country of Origin	DE 

Components	1x motor adapter, 1x magnetic coupling
Related Products	Motor adapter for Moebius 3 l single-use vessel and 8LVA2X motors (aluminum material) (BBI-44431051)
Description:	



To the Shop:



Alle / Verkaufsartikel / Accessories / Stirring and mixing / Motors

Motor 8WSB21 - complete with flange, coupling and collar



bbi Scancode	BBI-44431001
Manufacturer	bbi-biotech GmbH
Country of Origin	DE 

Components	1x motor, 1x adapter, 1x collar, 1x coupling
Related Products	Motor 8LVA13 - complete with flange, coupling and collar (BBI-44431002) Motor 8LVA22 - complete with flange, coupling and collar (BBI-44431003) Motor 8LVA33 - complete with flange, coupling and collar (BBI-44431005)
Description:	



To the Shop:



Alle / Verkaufsartikel / Accessories / Stirring and mixing / Motors

Motor 8LVA13 - complete with flange, coupling and collar



bbi Scancode	BBI-44431002
Manufacturer	bbi-biotech GmbH
Country of Origin	DE 
Weight	0.79 kg

Components	1x motor, 1x adapter, 1x collar, 1x coupling
Related Products	Motor 8LVA22 - complete with flange, coupling and collar (BBI-44431003) Motor 8LVA23 - complete with flange, coupling and collar (BBI-44431004) Motor 8LVA33 - complete with flange, coupling and collar (BBI-44431005)
Description:	



To the Shop:



Alle / Verkaufsartikel / Accessories / Stirring and mixing / Motors

Motor 8LVA22 - complete with flange, coupling and collar



bbi Scancode	BBI-44431003
Manufacturer	bbi-biotech GmbH
Country of Origin	DE 
Weight	1.64 kg

Components	1x motor, 1x adapter, 1x collar, 1x coupling
Related Products	Motor 8LVA13 - complete with flange, coupling and collar (BBI-44431002) Motor 8LVA23 - complete with flange, coupling and collar (BBI-44431004) Motor 8LVA33 - complete with flange, coupling and collar (BBI-44431005)
Description:	



To the Shop:



Alle / Verkaufsartikel / Accessories / Stirring and mixing / Motors

Motor 8LVA23 - complete with flange, coupling and collar



bbi Scancode	BBI-44431004
Manufacturer	bbi-biotech GmbH
Country of Origin	DE 
Weight	1.64 kg

Components	1x motor, 1x adapter, 1x collar, 1x coupling
Related Products	<p>Motor 8LVA13 - complete with flange, coupling and collar (BBI-44431002)</p> <p>Motor 8LVA22 - complete with flange, coupling and collar (BBI-44431003)</p> <p>Motor 8LVA33 - complete with flange, coupling and collar (BBI-44431005)</p>
Description:	



Alle / Verkaufsartikel / Accessories / Stirring and mixing / Motors

Motor 8LVA33 - complete with flange, coupling and collar



bbi Scancode	BBI-44431005
Manufacturer	bbi-biotech GmbH
Country of Origin	DE 

Components	1x motor, 1x adapter, 1x collar, 1x coupling
Related Products	Motor 8LVA13 - complete with flange, coupling and collar (BBI-44431002) Motor 8LVA22 - complete with flange, coupling and collar (BBI-44431003) Motor 8LVA23 - complete with flange, coupling and collar (BBI-44431004)
Description:	



To the Shop:



Alle / Verkaufsartikel / Accessories / Stirring and mixing / Motors

Motor 8LVA22 - complete with flange, coupling and collar for Applikon 3l



bbi Scancode	BBI-44431103
Manufacturer	bbi-biotech GmbH
Country of Origin	DE 

Components	1x motor, 1x adapter, 1x collar, 1x coupling
Related Products	<p>Motor 8LVA13 - complete with flange, coupling and collar (BBI-44431002)</p> <p>Motor 8LVA22 - complete with flange, coupling and collar (BBI-44431003)</p> <p>Motor 8LVA23 - complete with flange, coupling and collar (BBI-44431004)</p>

Description:



Alle / Verkaufsartikel / Accessories / Stirring and mixing / Paddle impellers

2-bladed paddle impeller, Ø 54 mm, 10 mm stirrer shaft



bbi Scancode	BBI-43230050
Manufacturer	bbi-biotech GmbH
Material Certificate	3.1, Rauigkeit
Country of Origin	DE 
HS-Code	84798200
Material	Stainless steel 316L

Components	1x stirrer, 4x grub screw
Related Products	2 L 2-bladed paddle impeller (BBI-43230314) 2 L 3-bladed-segment impeller (BBI-43230304) 2 L Rushton impeller (BBI-43230324)
Description: <ul style="list-style-type: none"> • Used for stirring in bioreactors • For shafts with diameter of 10 mm • Ø 54 mm • Suitable for extremely shear-sensitive cells • Suitable for microcarriers • Prevents sedimentation • Even at low speeds thorough mixing 	



To the Shop:



Alle / Verkaufsartikel / Accessories / Stirring and mixing / Paddle impellers

2-bladed paddle impeller, Ø 70 mm, 10 mm stirrer shaft



bbi Scancode	BBI-43230051
Manufacturer	bbi-biotech GmbH
Material Certificate	3.1, Rauigkeit
Country of Origin	DE 
HS-Code	84798200
Material	Stainless steel 316L

Components	1x stirrer, 4x grub screw
Related Products	3-blade segment impeller, Ø 90 mm, 10 mm stirrer shaft (BBI-43230027) 5 L 2-bladed paddle impeller (BBI-43230315) 6-bladed angled impeller, Ø 64 mm, 10 mm shaft (45° angle) (BBI-43231151)
Description: <ul style="list-style-type: none"> • Used for stirring in bioreactors • For shafts with diameter of 10 mm • Ø 70 mm • Suitable for extremely shear-sensitive cells • Suitable for microcarriers • Prevents sedimentation • Even at low speeds thorough mixing 	



To the Shop:



Alle / Verkaufsartikel / Accessories / Stirring and mixing / Paddle impellers

2-bladed paddle impeller, Ø 110 mm, 10 mm stirrer shaft



bbi Scancode	BBI-43230052
Manufacturer	bbi-biotech GmbH
Material Certificate	3.1, Rauigkeit
Country of Origin	DE 
HS-Code	84798200
Material	Stainless steel 316L

Components	1x stirrer, 4x grub screw
Related Products	10 L 2-bladed paddle impeller (BBI-43230316) 3-blade segment impeller, Ø 90 mm, 10 mm stirrer shaft (BBI-43230027) 5 L 2-bladed paddle impeller (BBI-43230315)

Description:

- Used for stirring in bioreactors
- For shafts with diameter of 10 mm
- Ø 110 mm
- Suitable for extremely shear-sensitive cells
- Suitable for microcarriers
- Prevents sedimentation
- Even at low speeds thorough mixing



To the Shop:



Alle / Verkaufsartikel / Accessories / Stirring and mixing / Paddle impellers

2-bladed paddle impeller, Ø 109 mm, 14 mm stirrer shaft



bbi Scancode	BBI-43230053
Manufacturer	bbi-biotech GmbH
Material Certificate	3.1, Rauigkeit
Country of Origin	DE 
HS-Code	84798200
Weight	0.1 kg
Material	Stainless steel 316L

Components	1x stirrer, 4x grub screw
Consumables	Grub screw for blades of 3-bladed-segment impeller & 2-bladed paddle impeller for mounting on the stirrer shaft (package of 10 pieces) (BBI-45110503) Grub screw for 3-bladed-segment impeller & 2-bladed paddle impeller for mounting on the stirrer shaft (package of 10 pieces) (BBI-45110504)
Related Products	2-bladed paddle impeller, Ø 118 mm, 14 mm stirrer shaft (BBI-43230054) 3-blade segment impeller, Ø 130 mm, 14 mm stirrer shaft (BBI-43230021) 6-bladed impeller, Ø 90 mm, 14 mm stirrer shaft (BBI-43230036)

Description:

- Used for stirring in bioreactors
- For shafts with diameter of 14 mm
- Ø 109 mm
- Suitable for extremely shear-sensitive cells
- Suitable for microcarriers
- Prevents sedimentation
- Even at low speeds thorough mixing



To the Shop:



Alle / Verkaufsartikel / Accessories / Stirring and mixing / Paddle impellers

2-bladed paddle impeller, Ø 118 mm, 14 mm stirrer shaft



bbi Scancode	BBI-43230054
Manufacturer	bbi-biotech GmbH
Material Certificate	3.1, Rauigkeit
Country of Origin	DE 
HS-Code	84798200
Material	Stainless steel 316L

Components	1x stirrer, 4x grub screw
Related Products	2-bladed paddle impeller, Ø 109 mm, 14 mm stirrer shaft (BBI-43230053) 3-blade segment impeller, Ø 130 mm, 14 mm stirrer shaft (BBI-43230021) 5 L 2-bladed paddle impeller (BBI-43230315)

Description:

- Used for stirring in bioreactors
- For shafts with diameter of 14 mm
- Ø 118 mm
- Suitable for extremely shear-sensitive cells
- Suitable for microcarriers
- Prevents sedimentation
- Even at low speeds thorough mixing



To the Shop:



Alle / Verkaufsartikel / Accessories / Stirring and mixing / Paddle impellers

2-bladed paddle impeller, Ø 135 mm, 18 mm stirrer shaft



bbi Scancode	BBI-43230055
Manufacturer	bbi-biotech GmbH
Material Certificate	3.1, Rauigkeit
Country of Origin	DE 
HS-Code	84798200
Material	Stainless steel 316L

Components	1x stirrer, 4x grub screw
Related Products	2-bladed paddle impeller, Ø 180 mm, 18 mm stirrer shaft (BBI-43230056) 3-blade segment impeller, Ø 130 mm, 18 mm stirrer shaft (BBI-43230013) 6-bladed impeller, Ø 104 mm, 18 mm stirrer shaft (BBI-43230010)

Description:

- Used for stirring in bioreactors
- For shafts with diameter of 18 mm
- Ø 135 mm
- Suitable for extremely shear-sensitive cells
- Suitable for microcarriers
- Prevents sedimentation
- Even at low speeds thorough mixing



To the Shop:



Alle / Verkaufsartikel / Accessories / Stirring and mixing / Paddle impellers

2-bladed paddle impeller, Ø 180 mm, 18 mm stirrer shaft



bbi Scancode	BBI-43230056
Manufacturer	bbi-biotech GmbH
Material Certificate	3.1, Rauigkeit
Country of Origin	DE 
HS-Code	84798200
Material	Stainless steel 316L

Components	1x stirrer, 4x grub screw
Related Products	10 L 2-bladed paddle impeller (BBI-43230316) 2-bladed paddle impeller, Ø 135 mm, 18 mm stirrer shaft (BBI-43230055) 3-blade segment impeller, Ø 130 mm, 18 mm stirrer shaft (BBI-43230013)

Description:

- Used for stirring in bioreactors
- For shafts with diameter of 18 mm
- Ø 180 mm
- Suitable for extremely shear-sensitive cells
- Suitable for microcarriers
- Prevents sedimentation
- Even at low speeds thorough mixing



To the Shop:



Alle / Verkaufsartikel / Accessories / Stirring and mixing / Paddle impellers

Chemineer P3, Ø 56mm, 10 mm stirrer shaft



bbi Scancode	BBI-43230080
Manufacturer	bbi-biotech GmbH
Material Certificate	3.1, Rauigkeit
Country of Origin	DE 
HS-Code	84798200
Material	Stainless steel 316L

Components	1x stirrer
Related Products	2-bladed paddle impeller, Ø 54 mm, 10 mm stirrer shaft (BBI-43230050) 3-blade segment impeller, Ø 54 mm, 10 mm stirrer shaft (BBI-43230025) CT6-stirrer; Ø 53mm, 10 mm stirrer shaft (BBI-43230070)
Description: <ul style="list-style-type: none"> • Used for stirring in bioreactors • For shafts with diameter of 10 mm • Ø 56 mm • Adjustable angles of paddles 	



To the Shop:



Alle / Verkaufsartikel / Accessories / Stirring and mixing / Paddle impellers

0.25 L 2-bladed paddle impeller



bbi Scancode	BBI-43230311
Manufacturer	bbi-biotech GmbH
Material Certificate	3.1, Rauigkeit
Country of Origin	DE 
HS-Code	84798200
Material	Stainless steel 316L

Components	1x stirrer, 4x grub screw
Related Products	0.25 L 3-bladed-segment impeller (BBI-43230301) 0.25 L Rushton impeller (BBI-43230321) 0.25 L stirrer shaft, 6 mm (BBI-43230047)

Description:

- Used for stirring in bioreactors
- For shafts with diameter of 6 mm
- Suitable for extremely shear-sensitive cells
- Suitable for microcarriers
- Prevents sedimentation
- Even at low speeds thorough mixing



To the Shop:



Alle / Verkaufsartikel / Accessories / Stirring and mixing / Paddle impellers

0.5 L 2-bladed paddle impeller



bbi Scancode	BBI-43230312
Manufacturer	bbi-biotech GmbH
Material Certificate	3.1, Rauigkeit
Country of Origin	DE 
HS-Code	84798200
Weight	0.04 kg
Material	Stainless steel 316L

Components	1x stirrer, 4x grub screw
Consumables	Grub screw for blades of 3-bladed-segment impeller & 2-bladed paddle impeller for mounting on the stirrer shaft (package of 10 pieces) (BBI-45110503) Grub screw for 3-bladed-segment impeller & 2-bladed paddle impeller for mounting on the stirrer shaft (package of 10 pieces) (BBI-45110504)
Related Products	0.5 L 3-bladed-segment impeller (BBI-43230302) 0.5 L Rushton impeller (BBI-43230322) 0.5 L stirrer shaft, 8 mm (BBI-43230042)

Description:

- Used for stirring in bioreactors
- For shafts with diameter of 8 mm
- Ø 54 mm
- Suitable for extremely shear-sensitive cells
- Suitable for microcarriers
- Prevents sedimentation
- Even at low speeds thorough mixing



Alle / Verkaufsartikel / Accessories / Stirring and mixing / Paddle impellers

1 L 2-bladed paddle impeller



bbi Scancode	BBI-43230313
Manufacturer	bbi-biotech GmbH
Material Certificate	3.1, Rauigkeit
Country of Origin	DE 
HS-Code	84798200
Weight	0.04 kg
Material	Stainless steel 316L

Components	1x stirrer, 4x grub screw
Consumables	Grub screw for blades of 3-bladed-segment impeller & 2-bladed paddle impeller for mounting on the stirrer shaft (package of 10 pieces) (BBI-45110503) Grub screw for 3-bladed-segment impeller & 2-bladed paddle impeller for mounting on the stirrer shaft (package of 10 pieces) (BBI-45110504)

Description:

- Used for stirring in bioreactors
- For shafts with diameter of 10 mm
- Ø 66 mm
- Suitable for extremely shear-sensitive cells
- Suitable for microcarriers
- Prevents sedimentation
- Even at low speeds thorough mixing



Alle / Verkaufsartikel / Accessories / Stirring and mixing / Paddle impellers

2 L 2-bladed paddle impeller



bbi Scancode	BBI-43230314
Manufacturer	bbi-biotech GmbH
Material Certificate	3.1, Rauigkeit
Country of Origin	DE 
HS-Code	84798200
Weight	0.04 kg
Material	Stainless steel 316L

Components	1x stirrer, 4x grub screw
Consumables	Grub screw for blades of 3-bladed-segment impeller & 2-bladed paddle impeller for mounting on the stirrer shaft (package of 10 pieces) (BBI-45110503) Grub screw for 3-bladed-segment impeller & 2-bladed paddle impeller for mounting on the stirrer shaft (package of 10 pieces) (BBI-45110504)
Related Products	2 L 3-bladed-segment impeller (BBI-43230304) 2 L Rushton impeller (BBI-43230324) 2 L stirrer shaft, 10 mm (BBI-43230041)

Description:

- Used for stirring in bioreactors
- For shafts with diameter of 10 mm
- Ø 78 mm
- Suitable for extremely shear-sensitive cells
- Suitable for microcarriers
- Prevents sedimentation
- Even at low speeds thorough mixing



Alle / Verkaufsartikel / Accessories / Stirring and mixing / Paddle impellers

5 L 2-bladed paddle impeller



bbi Scancode	BBI-43230315
Manufacturer	bbi-biotech GmbH
Material Certificate	3.1, Rauigkeit
Country of Origin	DE 
HS-Code	84798200
Weight	0.07 kg
Material	Stainless steel 316L

Components	1x stirrer, 4x grub screw
Consumables	Grub screw for blades of 3-bladed-segment impeller & 2-bladed paddle impeller for mounting on the stirrer shaft (package of 10 pieces) (BBI-45110503) Grub screw for 3-bladed-segment impeller & 2-bladed paddle impeller for mounting on the stirrer shaft (package of 10 pieces) (BBI-45110504)
Related Products	5 L 3-bladed-segment impeller (BBI-43230305) 5 L Rushton impeller (BBI-43230325) 5 L stirrer shaft, 10 mm (BBI-43230046)

Description:

- Used for stirring in bioreactors
- For shafts with diameter of 10 mm
- Ø 96 mm
- Suitable for extremely shear-sensitive cells
- Suitable for microcarriers
- Prevents sedimentation
- Even at low speeds thorough mixing



To the Shop:



Alle / Verkaufsartikel / Accessories / Stirring and mixing / Paddle impellers

10 L 2-bladed paddle impeller



bbi Scancode	BBI-43230316
Manufacturer	bbi-biotech GmbH
Material Certificate	3.1, Rauigkeit
Country of Origin	DE 
HS-Code	84798200
Weight	0.1 kg
Material	Stainless steel 316L

Components	1x stirrer, 4x grub screw
Consumables	Grub screw for blades of 3-bladed-segment impeller & 2-bladed paddle impeller for mounting on the stirrer shaft (package of 10 pieces) (BBI-45110503) Grub screw for 3-bladed-segment impeller & 2-bladed paddle impeller for mounting on the stirrer shaft (package of 10 pieces) (BBI-45110504)
Related Products	10 L 3-bladed-segment impeller (BBI-43230306) 10 L Rushton impeller (BBI-43230326) 10 L stirrer shaft, 16 mm (BBI-43230044)

Description:

- Used for stirring in bioreactors
- For shafts with diameter of 16 mm
- Ø 114 mm
- Suitable for extremely shear-sensitive cells
- Suitable for microcarriers
- Prevents sedimentation
- Even at low speeds thorough mixing



To the Shop:



Alle / Verkaufsartikel / Accessories / Stirring and mixing / Rushton impellers

6-bladed impeller, Ø 40 mm, 8 mm stirrer shaft



bbi Scancode	BBI-43230003
Manufacturer	bbi-biotech GmbH
Material Certificate	3.1, Rauigkeit
Country of Origin	DE 
HS-Code	84798200
Material	Stainless steel 316L

Components	1x impeller, 2x grub screw
Related Products	0.5 L Rushton impeller (BBI-43230322) 1 L Rushton impeller (BBI-43230323) 2 L Rushton impeller (BBI-43230324)

Description:

- impellers are used for mixing and oxygen supply to the fermentation culture
- Suitable for high speed in bioreactors
- Is used for shear force insensitive organisms
- For shafts with diameter of 8 mm
- Ø 40 mm
- Spare part for bioreactors



To the Shop:



Alle / Verkaufsartikel / Accessories / Stirring and mixing / Rushton impellers

6-bladed impeller, Ø 85 mm, 14 mm stirrer shaft



bbi Scancode	BBI-43230006
Manufacturer	bbi-biotech GmbH
Material Certificate	3.1, Rauigkeit
Country of Origin	DE 
HS-Code	84798200
Weight	0.11 kg
Material	Stainless steel 316L

Components	1x impeller, 2x grub screw
Consumables	Grub screw for 3-bladed-segment impeller & 2-bladed paddle impeller for mounting on the stirrer shaft (package of 10 pieces) (BBI-45110504)
Related Products	3-blade segment impeller, Ø 70 mm, 14 mm stirrer shaft (BBI-43230015) 6-bladed impeller, Ø 64 mm, 14 mm stirrer shaft (BBI-43230011) 6-bladed impeller, Ø 90 mm, 14 mm stirrer shaft (BBI-43230036)

Description:

- impellers are used for mixing and oxygen supply to the fermentation culture
- Suitable for high speed in bioreactors
- Is used for shear force insensitive organisms
- For shafts with diameter of 14 mm
- Ø 85 mm
- Spare part for bioreactors



Alle / Verkaufsartikel / Accessories / Stirring and mixing / Rushton impellers

6-bladed impeller, Ø 99 mm, 12 mm stirrer shaft



bbi Scancode	BBI-43230007
Manufacturer	bbi-biotech GmbH
Material Certificate	3.1, Rauigkeit
Country of Origin	DE 
HS-Code	84798200
Material	Stainless steel 316L

Components	1x impeller, 2x grub screw
Related Products	1 L Rushton impeller (BBI-43230323) 10 L Rushton impeller (BBI-43230326) 2 L Rushton impeller (BBI-43230324)
Description: <ul style="list-style-type: none"> • impellers are used for mixing and oxygen supply to the fermentation culture • Suitable for high speed in bioreactors • Is used for shear force insensitive organisms • For shafts with diameter of 12 mm • Ø 99 mm • Spare part for bioreactors 	



To the Shop:



Alle / Verkaufsartikel / Accessories / Stirring and mixing / Rushton impellers

6-bladed impeller, Ø 74 mm, 16 mm stirrer shaft



bbi Scancode	BBI-43230008
Manufacturer	bbi-biotech GmbH
Material Certificate	3.1, Rauigkeit
Country of Origin	DE 
HS-Code	84798200
Weight	0.12 kg
Material	Stainless steel 316L

Components	1x impeller, 2x grub screw
Related Products	<p>3-blade segment impeller, Ø 109 mm, 16 mm stirrer shaft (BBI-43230022)</p> <p>3-blade segment impeller, Ø 78 mm, 16 mm stirrer shaft (BBI-43230014)</p> <p>6-bladed impeller, Ø 94 mm, 16 mm stirrer shaft (BBI-43230009)</p>

Description:

- impellers are used for mixing and oxygen supply to the fermentation culture
- Suitable for high speed in bioreactors
- Is used for shear force insensitive organisms
- For shafts with diameter of 16 mm
- Ø 74 mm
- Spare part for bioreactors



Alle / Verkaufsartikel / Accessories / Stirring and mixing / Rushton impellers

6-bladed impeller, Ø 94 mm, 16 mm stirrer shaft



bbi Scancode	BBI-43230009
Manufacturer	bbi-biotech GmbH
Material Certificate	3.1, Rauigkeit
Country of Origin	DE 
HS-Code	84798200
Material	Stainless steel 316L

Components	1x impeller, 2x grub screw
Related Products	3-blade segment impeller, Ø 109 mm, 16 mm stirrer shaft (BBI-43230022) 3-blade segment impeller, Ø 78 mm, 16 mm stirrer shaft (BBI-43230014) 6-bladed impeller, Ø 74 mm, 16 mm stirrer shaft (BBI-43230008)

Description:

- impellers are used for mixing and oxygen supply to the fermentation culture
- Suitable for high speed in bioreactors
- Is used for shear force insensitive organisms
- For shafts with diameter of 16 mm
- Ø 94 mm
- Spare part for bioreactors



To the Shop:



Alle / Verkaufsartikel / Accessories / Stirring and mixing / Rushton impellers

6-bladed impeller, Ø 104 mm, 18 mm stirrer shaft



bbi Scancode	BBI-43230010
Manufacturer	bbi-biotech GmbH
Material Certificate	3.1, Rauigkeit
Country of Origin	DE 
HS-Code	84798200
Weight	0.23 kg
Material	Stainless steel 316L

Components	1x impeller, 2x grub screw
Related Products	10 L Rushton impeller (BBI-43230326) 6-bladed impeller, Ø 135 mm, 28 mm stirrer shaft (BBI-43231101) 6-bladed impeller, Ø 75 mm, 18 mm stirrer shaft (BBI-43230012)

Description:

- impellers are used for mixing and oxygen supply to the fermentation culture
- Suitable for high speed in bioreactors
- Is used for shear force insensitive organisms
- For shafts with diameter of 18 mm
- Ø 104 mm
- Spare part for bioreactors



To the Shop:



Alle / Verkaufsartikel / Accessories / Stirring and mixing / Rushton impellers

6-bladed impeller, Ø 64 mm, 14 mm stirrer shaft



bbi Scancode	BBI-43230011
Manufacturer	bbi-biotech GmbH
Material Certificate	3.1, Rauigkeit
Country of Origin	DE 
HS-Code	84798200
Material	Stainless steel 316L

Components	1x impeller, 2x grub screw
Consumables	Grub screw for Rushton stirrer for mounting on the stirrer shaft (package of 10 pieces) (BBI-45110502)
Related Products	3-blade segment impeller, Ø 70 mm, 14 mm stirrer shaft (BBI-43230015) 6-bladed angled impeller, Ø 64 mm, 10 mm shaft (45° angle) (BBI-43231151) 6-bladed impeller, Ø 85 mm, 14 mm stirrer shaft (BBI-43230006)

Description:

- impellers are used for mixing and oxygen supply to the fermentation culture
- Suitable for high speed in bioreactors
- Is used for shear force insensitive organisms
- For shafts with diameter of 14 mm
- Ø 64 mm
- Spare part for bioreactors



To the Shop:



Alle / Verkaufsartikel / Accessories / Stirring and mixing / Rushton impellers

6-bladed impeller, Ø 75 mm, 18 mm stirrer shaft



bbi Scancode	BBI-43230012
Manufacturer	bbi-biotech GmbH
Material Certificate	3.1, Rauigkeit
Country of Origin	DE 
HS-Code	84798200
Material	Stainless steel 316L

Components	1x impeller, 2x grub screw
Related Products	2-bladed paddle impeller, Ø 135 mm, 18 mm stirrer shaft (BBI-43230055) 3-blade segment impeller, Ø 95 mm, 18 mm stirrer shaft (BBI-43230023) 6-bladed impeller, Ø 104 mm, 18 mm stirrer shaft (BBI-43230010)
Description: <ul style="list-style-type: none"> • impellers are used for mixing and oxygen supply to the fermentation culture • Suitable for high speed in bioreactors • Is used for shear force insensitive organisms • For shafts with diameter of 18 mm • Ø 75 mm • Spare part for bioreactors 	



To the Shop:



Alle / Verkaufsartikel / Accessories / Stirring and mixing / Rushton impellers

6-bladed impeller, Ø 90 mm, 14 mm stirrer shaft



bbi Scancode	BBI-43230036
Manufacturer	bbi-biotech GmbH
Material Certificate	3.1, Rauigkeit
Country of Origin	DE 
HS-Code	84798200
Material	Stainless steel 316L

Components	1x stirrer, 2x grub screw
Related Products	3-blade segment impeller, Ø 70 mm, 14 mm stirrer shaft (BBI-43230015) 3-blade segment impeller, Ø 90 mm, 10 mm stirrer shaft (BBI-43230027) 6-bladed impeller, Ø 85 mm, 14 mm stirrer shaft (BBI-43230006)

Description:

- Stirrers are used for mixing and oxygen supply to the fermentation culture
- Suitable for high speed in bioreactors
- Is used for shear force insensitive organisms
- For shafts with diameter of 14 mm
- Ø 90 mm
- Spare part for bioreactors



To the Shop:



Alle / Verkaufsartikel / Accessories / Stirring and mixing / Rushton impellers

0.25 L Rushton impeller



bbi Scancode	BBI-43230321
Manufacturer	bbi-biotech GmbH
Material Certificate	3.1, Rauigkeit
Country of Origin	DE 
HS-Code	84798200
Weight	0.01 kg
Material	Stainless steel 316L

Components	1x stirrer, 2x grub screw
Related Products	<p>0.25 L 2-bladed paddle impeller (BBI-43230311)</p> <p>0.25 L 3-bladed-segment impeller (BBI-43230301)</p> <p>0.25 L stirrer shaft, 6 mm (BBI-43230047)</p>

Description:

- Stirrers are used for mixing and oxygen supply to the fermentation culture
- Suitable for high speed in bioreactors
- Is used for shear force insensitive organisms
- For shafts with diameter of 6 mm
- Ø 26 mm
- Spare part for bioreactors



Alle / Verkaufsartikel / Accessories / Stirring and mixing / Rushton impellers

0.5 L Rushton impeller



bbi Scancode	BBI-43230322
Manufacturer	bbi-biotech GmbH
Material Certificate	3.1, Rauigkeit
Country of Origin	DE 
HS-Code	84798200
Weight	0.02 kg
Material	Stainless steel 316L

Components	1x stirrer, 2x grub screw
Consumables	Grub screw for Rushton stirrer for mounting on the stirrer shaft (package of 10 pieces) (BBI-45110502)
Related Products	0.5 L 2-bladed paddle impeller (BBI-43230312) 0.5 L 3-bladed-segment impeller (BBI-43230302) 0.5 L stirrer shaft, 8 mm (BBI-43230042)

Description:

- Stirrers are used for mixing and oxygen supply to the fermentation culture
- Suitable for high speed in bioreactors
- Is used for shear force insensitive organisms
- For shafts with diameter of 8 mm
- Ø 36 mm
- Spare part for bioreactors



To the Shop:



Alle / Verkaufsartikel / Accessories / Stirring and mixing / Rushton impellers

1 L Rushton impeller



bbi Scancode	BBI-43230323
Manufacturer	bbi-biotech GmbH
Material Certificate	3.1, Rauigkeit
Country of Origin	DE 
HS-Code	84798200
Weight	0.03 kg
Material	Stainless steel 316L

Components	1x stirrer, 2x grub screw
Consumables	Grub screw for Rushton stirrer for mounting on the stirrer shaft (package of 10 pieces) (BBI-45110502)

Description:

- Stirrers are used for mixing and oxygen supply to the fermentation culture
- Suitable for high speed in bioreactors
- Is used for shear force insensitive organisms
- For shafts with diameter of 10 mm
- Ø 44 mm
- Spare part for bioreactors



To the Shop:



Alle / Verkaufsartikel / Accessories / Stirring and mixing / Rushton impellers

2 L Rushton impeller



bbi Scancode	BBI-43230324
Manufacturer	bbi-biotech GmbH
Material Certificate	3.1, Rauigkeit
Country of Origin	DE 
HS-Code	84798200
Weight	0.03 kg
Material	Stainless steel 316L

Components	1x stirrer, 2x grub screw
Consumables	Grub screw for Rushton stirrer for mounting on the stirrer shaft (package of 10 pieces) (BBI-45110502)
Related Products	2 L 2-bladed paddle impeller (BBI-43230314) 2 L 3-bladed-segment impeller (BBI-43230304) 2 L stirrer shaft, 10 mm (BBI-43230041)

Description:

- Stirrers are used for mixing and oxygen supply to the fermentation culture
- Suitable for high speed in bioreactors
- Is used for shear force insensitive organisms
- For shafts with diameter of 10 mm
- Ø 52 mm
- Spare part for bioreactors



Alle / Verkaufsartikel / Accessories / Stirring and mixing / Rushton impellers

5 L Rushton impeller



bbi Scancode	BBI-43230325
Manufacturer	bbi-biotech GmbH
Material Certificate	3.1, Rauigkeit
Country of Origin	DE 
HS-Code	84798200
Weight	0.05 kg
Material	Stainless steel 316L

Components	1x stirrer, 2x grub screw
Consumables	Grub screw for Rushton stirrer for mounting on the stirrer shaft (package of 10 pieces) (BBI-45110502)
Related Products	5 L 2-bladed paddle impeller (BBI-43230315) 5 L 3-bladed-segment impeller (BBI-43230305) 5 L stirrer shaft, 10 mm (BBI-43230046)

Description:

- Stirrers are used for mixing and oxygen supply to the fermentation culture
- Suitable for high speed in bioreactors
- Is used for shear force insensitive organisms
- For shafts with diameter of 10 mm
- Ø 64 mm
- Spare part for bioreactors



Alle / Verkaufsartikel / Accessories / Stirring and mixing / Rushton impellers

10 L Rushton impeller



bbi Scancode	BBI-43230326
Manufacturer	bbi-biotech GmbH
Material Certificate	3.1, Rauigkeit
Country of Origin	DE 
HS-Code	84798200
Weight	0.07 kg
Material	Stainless steel 316L

Components	1x stirrer, 2x grub screw
Consumables	Grub screw for Rushton stirrer for mounting on the stirrer shaft (package of 10 pieces) (BBI-45110502)
Related Products	10 L 2-bladed paddle impeller (BBI-43230316) 10 L 3-bladed-segment impeller (BBI-43230306) 10 L stirrer shaft, 16 mm (BBI-43230044)

Description:

- Stirrers are used for mixing and oxygen supply to the fermentation culture
- Suitable for high speed in bioreactors
- Is used for shear force insensitive organisms
- For shafts with diameter of 16 mm
- Ø 76 mm
- Spare part for bioreactors



Alle / Verkaufsartikel / Accessories / Stirring and mixing / Rushton impellers

10 L Rushton impeller



bbi Scancode	BBI-43230703
Manufacturer	bbi-biotech GmbH
Material Certificate	3.1, Rauigkeit
Country of Origin	DE 
HS-Code	84798200
Material	Stainless steel 316L

Components	1x stirrer, 2x grub screw
<p>Description:</p> <ul style="list-style-type: none"> • Stirrers are used for mixing and oxygen supply to the fermentation culture • Suitable for high speed in bioreactors • Is used for shear force insensitive organisms • Spare part for bioreactors 	



Alle / Verkaufsartikel / Accessories / Stirring and mixing / Rushton impellers

20 L Rushton impeller



bbi Scancode	BBI-43230704
Manufacturer	bbi-biotech GmbH
Material Certificate	3.1, Rauigkeit
Country of Origin	DE 
HS-Code	84798200
Material	Stainless steel 316L

Components	1x stirrer, 2x grub screw
Related Products	20 L Pt100 casing (BBI-43430022) 20 L aeration basket (BBI-43530104) 20 L ring sparger, downwards-facing holes (BBI-43530093)

Description:

- Stirrers are used for mixing and oxygen supply to the fermentation culture
- Suitable for high speed in bioreactors
- Is used for shear force insensitive organisms
- For shafts with diameter of 18 mm
- Ø 105.5 mm
- Spare part for bioreactors



Alle / Verkaufsartikel / Accessories / Stirring and mixing / Rushton impellers

30 L Rushton impeller



bbi Scancode	BBI-43230705
Manufacturer	bbi-biotech GmbH
Material Certificate	3.1, Rauigkeit
Country of Origin	DE 
HS-Code	84798200
Weight	0.21 kg
Material	Stainless steel 316L

Components	1x stirrer, 2x grub screw
Consumables	Grub screw for Rushton stirrer for mounting on the stirrer shaft (package of 10 pieces) (BBI-45110502)
Related Products	30 L 3-bladed-segment impeller (BBI-43230715)

Description:

- Stirrers are used for mixing and oxygen supply to the fermentation culture
- Suitable for high speed in bioreactors
- Is used for shear force insensitive organisms
- For shafts with diameter of 18 mm
- Ø 130.9 mm
- Spare part for bioreactors



To the Shop:



Alle / Verkaufsartikel / Accessories / Stirring and mixing / Rushton impellers

6-bladed impeller, Ø 138 mm, 40 mm stirrer shaft



bbi Scancode	BBI-43230707
Manufacturer	bbi-biotech GmbH
Material Certificate	3.1, Rauigkeit
Country of Origin	DE 
HS-Code	84798200
Weight	0,38 kg
Material	Stainless steel 316L

Components	1x stirrer, 2x grub screw
Related Products	20 L Rushton impeller (BBI-43230704) 6-bladed impeller, Ø 135 mm, 28 mm stirrer shaft (BBI-43231101) 6-bladed impeller, Ø 75 mm, 18 mm stirrer shaft (BBI-43230012)
Description: <ul style="list-style-type: none"> • Stirrers are used for mixing and oxygen supply to the fermentation culture • Suitable for high speed in bioreactors • Is used for shear force insensitive organisms • Spare part for bioreactors 	



To the Shop:



Alle / Verkaufsartikel / Accessories / Stirring and mixing / Rushton impellers

6-bladed impeller, Ø 135 mm, 28 mm stirrer shaft



bbi Scancode	BBI-43231101
Manufacturer	bbi-biotech GmbH
Material Certificate	3.1, Rauigkeit
Country of Origin	DE 
HS-Code	84798200
Weight	0.95 kg
Material	Stainless steel 316L

Components	1x stirrer, 2x grub screw
Related Products	6-bladed impeller, Ø 104 mm, 18 mm stirrer shaft (BBI-43230010) 6-bladed impeller, Ø 164 mm, 38 mm stirrer shaft (BBI-43231133) 6-bladed impeller, Ø 99 mm, 12 mm stirrer shaft (BBI-43230007)

Description:

- Stirrers are used for mixing and oxygen supply to the fermentation culture
- Suitable for high speed in bioreactors
- Is used for shear force insensitive organisms
- For shafts with diameter of 28 mm
- Ø 135 mm
- Spare part for bioreactors



To the Shop:



Alle / Verkaufsartikel / Accessories / Stirring and mixing / Rushton impellers

6-bladed impeller, Ø 164 mm, 38 mm stirrer shaft



bbi Scancode	BBI-43231133
Manufacturer	bbi-biotech GmbH
Material Certificate	3.1, Rauigkeit
Material	Stainless steel 316L

Components	1x stirrer, 2x grub screw
Related Products	4-bladed angled impeller, Ø 164 mm, 38 mm shaft (BBI-43230811) 6-bladed impeller, Ø 211 mm, 38 mm stirrer shaft (BBI-43231134) 6-bladed impeller, Ø 99 mm, 12 mm stirrer shaft (BBI-43230007)

Description:

- Stirrers are used for mixing and oxygen supply to the fermentation culture
- Suitable for high speed in bioreactors
- Is used for shear force insensitive organisms
- For shafts with diameter of 38 mm
- Ø 164 mm
- Spare part for bioreactors



To the Shop:



Alle / Verkaufsartikel / Accessories / Stirring and mixing / Rushton impellers

6-bladed impeller, Ø 211 mm, 38 mm stirrer shaft



bbi Scancode	BBI-43231134
Manufacturer	bbi-biotech GmbH
Material Certificate	3.1, Rauigkeit
Material	Stainless steel 316L

Components	1x stirrer, 2x grub screw
Related Products	4-bladed angled impeller, Ø 211 mm, 38 mm shaft (BBI-43230812) 6-bladed impeller, Ø 135 mm, 28 mm stirrer shaft (BBI-43231101) 6-bladed impeller, Ø 164 mm, 38 mm stirrer shaft (BBI-43231133)
Description: <ul style="list-style-type: none"> • Stirrers are used for mixing and oxygen supply to the fermentation culture • Suitable for high speed in bioreactors • Is used for shear force insensitive organisms • For shafts with diameter of 38 mm • Ø 211 mm • Spare part for bioreactors 	



To the Shop:



Alle / Verkaufsartikel / Accessories / Stirring and mixing / Rushton impellers

Grub screw for Rushton stirrer for mounting on the stirrer shaft (package of 10 pieces)



bbi Scancode	BBI-45110502
HS-Code	73181535

Components	10x grub screw
Related Products	<p>2 L Rushton impeller (BBI-43230324)</p> <p>Grub screw for 3-bladed-segment impeller & 2-bladed paddle impeller for mounting on the stirrer shaft (package of 10 pieces) (BBI-45110504)</p> <p>Grub screw for blades of 3-bladed-segment impeller & 2-bladed paddle impeller for mounting on the stirrer shaft (package of 10 pieces) (BBI-45110503)</p>
<p>Description:</p> <p>Spare part for Rushton stirrer</p>	



Alle / Verkaufsartikel / Accessories / Stirring and mixing / Stirrer shafts

1 L stirrer shaft, 10 mm



bbi Scancode	BBI-43230040
Manufacturer	bbi-biotech GmbH
External Thread	M 38 x 1,5
Installation Depth	148 mm
Material Certificate	3.1, Rauigkeit, FDA
Country of Origin	DE 
HS-Code	84798200
Weight	0.73 kg
Material	Stainless steel 316L EPDM black PA 2200 - polyamide white

Components	1x stirrer shaft; 1x o-ring [BBI-45100018]
Consumables	O-ring for stirrer shaft (BBI-45100018) Wear parts for stirrer shafts up to 10 L (BBI-60000205)
<p>Description:</p> <ul style="list-style-type: none"> • Stirrer shaft with single mechanical seal • Shaft diameter: 10 mm • For use 3-, 6-bladed or other impellers • Delivery without coupling (available separately) 	



Alle / Verkaufsartikel / Accessories / Stirring and mixing / Stirrer shafts

2 L stirrer shaft, 10 mm



bbi Scancode	BBI-43230041
Manufacturer	bbi-biotech GmbH
External Thread	M 38 x 1,5
Installation Depth	212 mm
Material Certificate	3.1, Rauigkeit, FDA
Country of Origin	DE 
HS-Code	84798200
Material	Stainless steel 316L EPDM black PA 2200 - polyamide white

Components	1x stirrer shaft; 1x o-ring [BBI-45100018]
Consumables	Wear parts for stirrer shafts up to 10 L (BBI-60000205) O-ring for stirrer shaft (BBI-45100018)
Related Products	2 L 2-bladed paddle impeller (BBI-43230314) 2 L 3-bladed-segment impeller (BBI-43230304) 2 L Rushton impeller (BBI-43230324)

Description:

- Stirrer shaft with single mechanical seal
- Shaft diameter: 10 mm
- For use 3-, 6-bladed or other impellers
- Delivery without coupling (available separately)



Alle / Verkaufsartikel / Accessories / Stirring and mixing / Stirrer shafts

0.5 L stirrer shaft, 8 mm



bbi Scancode	BBI-43230042
Manufacturer	bbi-biotech GmbH
External Thread	M 38 x 1,5
Installation Depth	116 mm
Material Certificate	3.1, Rauigkeit, FDA
Country of Origin	DE 
HS-Code	84798200
Weight	0.69 kg
Material	Stainless steel 316L EPDM black PA 2200 - polyamide white

Components	1x stirrer shaft; 1x o-ring [BBI-45100018]
Consumables	Wear parts for stirrer shafts up to 10 L (BBI-60000205) O-ring for stirrer shaft (BBI-45100018)
Related Products	0.5 L 2-bladed paddle impeller (BBI-43230312) 0.5 L 3-bladed-segment impeller (BBI-43230302) 0.5 L Rushton impeller (BBI-43230322)

Description:

- Stirrer shaft with single mechanical seal
- Shaft diameter: 8 mm
- For use 3-, 6-bladed or other impellers
- Delivery without coupling (available separately)



Alle / Verkaufsartikel / Accessories / Stirring and mixing / Stirrer shafts

5 L stirrer shaft, 14 mm



bbi Scancode	BBI-43230043
Manufacturer	bbi-biotech GmbH
External Thread	M 38 x 1,5
Installation Depth	303 mm
Material Certificate	3.1, Rauigkeit, FDA
Country of Origin	DE 
HS-Code	84798200
Weight	1.0 kg
Material	Stainless steel 316L EPDM black PA 2200 - polyamide white

Components	1x stirrer shaft; 1x o-ring [BBI-45100018]
Consumables	Wear parts for stirrer shafts up to 10 L (BBI-60000205) O-ring for stirrer shaft (BBI-45100018)
Related Products	3-blade segment impeller, Ø 70 mm, 14 mm stirrer shaft (BBI-43230015) 5 L stirrer shaft, 10 mm (BBI-43230046) 6-bladed impeller, Ø 64 mm, 14 mm stirrer shaft (BBI-43230011)

Description:

- Stirrer shaft with single mechanical seal
- Shaft diameter: 14 mm
- For use 3-, 6-bladed or other impellers
- Delivery without coupling (available separately)



To the Shop:



Alle / Verkaufsartikel / Accessories / Stirring and mixing / Stirrer shafts

10 L stirrer shaft, 16 mm



bbi Scancode	BBI-43230044
Manufacturer	bbi-biotech GmbH
External Thread	M 38 x 1,5
Installation Depth	419 mm
Material Certificate	3.1, Rauigkeit, FDA
Country of Origin	DE 
HS-Code	84798200
Weight	1.28 kg
Material	Stainless steel 316L EPDM black PA 2200 - polyamide white

Components	1x stirrer shaft; 1x o-ring [BBI-45100018]
Consumables	Wear parts for stirrer shafts up to 10 L (BBI-60000205) O-ring for stirrer shaft (BBI-45100018)
Related Products	10 L 2-bladed paddle impeller (BBI-43230316) 10 L 3-bladed-segment impeller (BBI-43230306) 10 L Rushton impeller (BBI-43230326)

Description:

- Stirrer shaft with single mechanical seal
- Shaft diameter: 16 mm
- For use 3-, 6-bladed or other impellers
- Delivery without coupling (available separately)



Alle / Verkaufsartikel / Accessories / Stirring and mixing / Stirrer shafts

10 L stirrer shaft, 18 mm (in-situ)



bbi Scancode	BBI-43230045
Manufacturer	bbi-biotech GmbH
External Thread	M 38 x 1,5
Material Certificate	3.1, Rauigkeit, FDA
Country of Origin	DE 
HS-Code	84798200
Material	Stainless steel 316L EPDM black PA 2200 - polyamide white

Components

1x stirrer shaft; 1x o-ring [BBI-45100018]

Description:

- Shaft diameter: 18 mm
- For use 3-, 6-bladed or other impellers
- Delivery without coupling (available separately)



To the Shop:



Alle / Verkaufsartikel / Accessories / Stirring and mixing / Stirrer shafts

5 L stirrer shaft, 10 mm



bbi Scancode	BBI-43230046
Manufacturer	bbi-biotech GmbH
External Thread	M 38 x 1,5
Installation Depth	303 mm
Material Certificate	3.1, Rauigkeit, FDA
Country of Origin	DE 
HS-Code	84798200
Weight	1.0 kg
Material	Stainless steel 316L EPDM black PA 2200 - polyamide white

Components	1x stirrer shaft; 1x o-ring [BBI-45100018]
Consumables	Wear parts for stirrer shafts up to 10 L (BBI-60000205) O-ring for stirrer shaft (BBI-45100018)
Related Products	5 L 2-bladed paddle impeller (BBI-43230315) 5 L 3-bladed-segment impeller (BBI-43230305) 5 L Rushton impeller (BBI-43230325)

Description:

- Stirrer shaft with single mechanical seal
- Shaft diameter: 10 mm
- For use 3-, 6-bladed or other impellers
- Delivery without coupling (available separately)



To the Shop:



Alle / Verkaufsartikel / Accessories / Stirring and mixing / Stirrer shafts

0.25 L stirrer shaft, 6 mm



bbi Scancode	BBI-43230047
Manufacturer	bbi-biotech GmbH
External Thread	M 26 x 1
Material Certificate	3.1, Rauigkeit, FDA
Country of Origin	DE 
HS-Code	84798200
Material	Stainless steel 316L EPDM black PA 2200 - polyamide white

Components	1x stirrer shaft; 1x o-ring
Consumables	O-ring for stirrer shaft (BBI-45100018)
Related Products	0.25 L 2-bladed paddle impeller (BBI-43230311) 0.25 L 3-bladed-segment impeller (BBI-43230301) 0.25 L Rushton impeller (BBI-43230321)

Description:

- Stirrer shaft with single mechanical seal
- Shaft diameter: 6 mm
- For use 3-, 6-bladed or other impellers
- Delivery without coupling (available separately)



To the Shop:



Alle / Verkaufsartikel / Accessories / Stirring and mixing / Stirrer shafts

20 L stirrer shaft, bottom drive, for 2:1-vessel



bbi Scancode	BBI-43230120
Weight	4.1 kg

Components

Description:



To the Shop:



Alle / Verkaufsartikel / Accessories / Stirring and mixing / Stirrer shafts

0.5-10 L protection cap stirrer shaft



bbi Scancode	BBI-43230201
Manufacturer	bbi-biotech GmbH
Country of Origin	DE 
HS-Code	39269097
Material	PA 2200 - polyamide white

Components	1x protection cap
Related Products	0.25 L protection cap stirrer shaft (BBI-43230202) O-ring for stirrer shaft (BBI-45100018) PowerGrip coupling for 10 mm stirrer shaft (BBI-44430402)
Description: Protection cap white for bearing housing of the stirrer shaft	



To the Shop:



Alle / Verkaufsartikel / Accessories / Stirring and mixing / Stirrer shafts

0.25 L protection cap stirrer shaft



bbi Scancode	BBI-43230202
Manufacturer	bbi-biotech GmbH
Country of Origin	DE 
HS-Code	39269097
Material	PA 2200 - polyamide white

Components	1x protection cap
Related Products	<ul style="list-style-type: none"> 0,25 L Pt100 sleeve (BBI-43430000) 0.25 L single-walled glass vessel (BBI-44430299) 0.25 L stirrer shaft, 6 mm (BBI-43230047)
<p>Description:</p> <p>Protection cap white for bearing housing of the stirrer shaft</p>	



Alle / Verkaufsartikel / Accessories / Stirring and mixing / Stirrer shafts

Mechanical seal for shaft 0.5 - 10 L



bbi Scancode	BBI-45100207
Country of Origin	DE 
HS-Code	84842000

Components	1x mechanical seal
Related Products	Mechanical seal for shaft 0,25 L (BBI-45100208) Wear parts for stirrer shafts up to 10 L (BBI-60000205) Wear parts for stirrer shafts up to 10 L (without mechanical seal) (BBI-60000204)
Description: <ul style="list-style-type: none"> Spare part for stirrer shafts of a bioreactor 	



To the Shop:



Alle / Verkaufsartikel / Accessories / Stirring and mixing / Stirrer shafts

Mechanical seal for shaft 0,25 L



bbi Scancode	BBI-45100208
Country of Origin	DE 
HS-Code	84842000

Components	1x mechanical seal
Related Products	<p>0.25 L stirrer shaft, 6 mm (BBI-43230047)</p> <p>Mechanical seal for shaft 0.5 - 10 L (BBI-45100207)</p> <p>Wear parts for stirrer shafts up to 10 L (without mechanical seal) (BBI-60000204)</p>
<p>Description:</p> <ul style="list-style-type: none"> Spare part for stirrer shafts of a bioreactor 	



Alle / Verkaufsartikel / Accessories / Stirring and mixing / Stirrer shafts

Ball bearing for shaft 0,5 - 10 L (package of 2 pieces)



bbi Scancode	BBI-45100209
Country of Origin	CN 
HS-Code	84821090
Weight	0.03 kg

Components	2x ball bearing
Related Products	10 L stirrer shaft, 16 mm (BBI-43230044) 2 L stirrer shaft, 10 mm (BBI-43230041) 5 L stirrer shaft, 10 mm (BBI-43230046)
Description: <ul style="list-style-type: none"> • Ball bearing stainless steel • Single row • Spare part for stirrer shafts of a bioreactor 	



To the Shop:



Alle / Verkaufsartikel / Accessories / Stirring and mixing / Stirrer shafts

Wear parts for stirrer shafts up to 10 L (without mechanical seal)



bbi Scancode	BBI-60000204
Material Certificate	FDA
Country of Origin	DE 

Components	2x O-rings; 2x ball bearings; 3x circlips; 1x V-seal
Related Products	Mechanical seal for shaft 0,25 L (BBI-45100208) Mechanical seal for shaft 0.5 - 10 L (BBI-45100207) Replacement set of seals for stirrer shaft (0.5 - 10 L) (BBI-43930203)
<p>Description:</p> <p>If you want to replace the wear parts of your stirrer shafts yourself, you can obtain a complete package with mechanical seal, O-rings, ball bearings, circlips and V-seal from bbi-biotech. We are also happy to replace the spare parts for you.</p>	



Alle / Verkaufsartikel / Accessories / Stirring and mixing / Stirrer shafts

Wear parts for stirrer shafts up to 10 L



bbi Scancode	BBI-60000205
Material Certificate	FDA
Country of Origin	DE 

Components	2x O-rings; 2x ball bearings; 3x circlips; 1x V-seal; 1x mechanical seal [BBI-45100207]
Related Products	Replacement set of seals for stirrer shaft (0.5 - 10 L) (BBI-43930203) Wear parts set for 10 L vessels xCUBIO (BBI-45110606) Wear parts set for 5 L vessels xCUBIO (BBI-45110605)
<p>Description:</p> <p>If you want to replace the wear parts of your stirrer shafts yourself, you can obtain a complete package with mechanical seal, O-rings, ball bearings, circlips and V-seal from bbi-biotech.</p>	



Alle / Verkaufsartikel / Accessories / Stirring and mixing / Stirrer shafts

Wear parts for Biostat C/C+ stirrer shafts up to 30 L (without mechanical seal)



bbi Scancode	BBI-60000214
Manufacturer	bbi-biotech GmbH
Country of Origin	DE 

Components	
Related Products	Wear parts for Biostat C/C+ stirrer shafts up to 30 L (BBI-60000215) Wear parts set for 0.5 L vessels xCUBIO (BBI-45110602) Wear parts set for 10 L vessels xCUBIO (BBI-45110606)
Description: Delivery of wear parts for stirrer shafts: <ul style="list-style-type: none"> • O-rings • Deep groove ball bearing • Circlips • V-seal 	



Alle / Verkaufsartikel / Accessories / Stirring and mixing / Stirrer shafts

Wear parts for Biostat C/C+ stirrer shafts up to 30 L



bbi Scancode	BBI-60000215
Manufacturer	bbi-biotech GmbH
Country of Origin	DE 

Components	
Related Products	<p>Wear parts for Biostat C/C+ stirrer shafts up to 30 L (without mechanical seal) (BBI-60000214)</p> <p>Wear parts for stirrer shafts up to 10 L (BBI-60000205)</p> <p>Wear parts for stirrer shafts up to 10 L (without mechanical seal) (BBI-60000204)</p>
<p>Description:</p> <p>Delivery of wear parts for stirrer shafts:</p> <ul style="list-style-type: none"> • Mechanical seal • O-rings • Deep groove ball bearing • Circlips • V-seal 	



Alle / Verkaufsartikel / Accessories / Stirring and mixing / Stirrer shafts

Replacement ball bearing for Biostat C/C+ stirrer shafts



bbi Scancode

BBI-60000216

Components

2x ball bearings

Description:



To the Shop:



Alle / Verkaufsartikel / Accessories / Stirring and mixing / Special impeller designs

CT6-stirrer; Ø 53mm, 10 mm stirrer shaft



bbi Scancode	BBI-43230070
Manufacturer	bbi-biotech GmbH
Material Certificate	3.1, Rauigkeit
Country of Origin	DE 
HS-Code	84798200
Material	Stainless steel 316L

Components	1x stirrer
Related Products	2-bladed paddle impeller, Ø 54 mm, 10 mm stirrer shaft (BBI-43230050) 3-blade segment impeller, Ø 54 mm, 10 mm stirrer shaft (BBI-43230025) Chemineer P3, Ø 56mm, 10 mm stirrer shaft (BBI-43230080)
Description: <ul style="list-style-type: none"> • Used for stirring in bioreactors • For shafts with diameter of 10 mm • Ø 53 mm 	



To the Shop:



Alle / Verkaufsartikel / Accessories / Stirring and mixing / Special impeller designs

2 L foam breaker disc



bbi Scancode	BBI-43230409
Manufacturer	bbi-biotech GmbH
Material Certificate	3.1, Rauigkeit
Country of Origin	DE 
HS-Code	84798200
Material	Stainless steel 316L

Components	1x foam breaker disc 2x grub screw
Related Products	2 L jacketed glass vessel (BBI-44430024) 2 L stirrer shaft, 10 mm (BBI-43230041) 5 L foam breaker disc (BBI-43230410)

Description:

- To mechanically destroy foam
- Foaming may block the exhaust filter
- Destruction of the foam on the surface of the medium
- Mounting on the stirrer shaft
- Spare part for bioreactors



Alle / Verkaufsartikel / Accessories / Stirring and mixing / Special impeller designs

5 L foam breaker disc



bbi Scancode	BBI-43230410
Manufacturer	bbi-biotech GmbH
Material Certificate	3.1, Rauigkeit
Country of Origin	DE 
HS-Code	84798200
Material	Stainless steel 316L

Components	1x foam breaker disc 2x grub screw
Related Products	2 L foam breaker disc (BBI-43230409) Antifoam or level probe L=100 mm (BBI-44630003) Antifoam or level probe L=80 mm (BBI-44630002)
<p>Description:</p> <ul style="list-style-type: none"> • To mechanically destroy foam • Foaming may block the exhaust filter • Destruction of the foam on the surface of the medium • Mounting on the stirrer shaft • Spare part for bioreactors 	



Alle / Verkaufsartikel / Accessories / Stirring and mixing / Special impeller designs

4-bladed angled impeller, Ø 164 mm, 38 mm shaft



bbi Scancode	BBI-43230811
Manufacturer	bbi-biotech GmbH
Material Certificate	3.1, Rauigkeit
Country of Origin	DE 
Material	Stainless steel 316L

Components	1x stirrer, 2x grub screw
Related Products	<p>4-bladed angled impeller, Ø 211 mm, 38 mm shaft (BBI-43230812)</p> <p>6-bladed angled impeller, Ø 64 mm, 10 mm shaft (45° angle) (BBI-43231151)</p> <p>6-bladed impeller, Ø 164 mm, 38 mm stirrer shaft (BBI-43231133)</p>

Description:

- Used for stirring in bioreactors
- Suitable for shear-sensitive cells
- Suitable for microcarriers
- Prevents sedimentation
- Even at low speeds thorough mixing
- Ø 164 mm, for 38 mm shaft
- Spare part for bioreactors



To the Shop:



Alle / Verkaufsartikel / Accessories / Stirring and mixing / Special impeller designs

4-bladed angled impeller, Ø 211 mm, 38 mm shaft



bbi Scancode	BBI-43230812
Manufacturer	bbi-biotech GmbH
Material Certificate	3.1, Rauigkeit
Material	Stainless steel 316L

Components	1x stirrer, 2x grub screw
Related Products	4-bladed angled impeller, Ø 164 mm, 38 mm shaft (BBI-43230811) 6-bladed angled impeller, Ø 64 mm, 10 mm shaft (45° angle) (BBI-43231152) 6-bladed impeller, Ø 211 mm, 38 mm stirrer shaft (BBI-43231134)
Description: <ul style="list-style-type: none"> • Used for stirring in bioreactors • Suitable for shear-sensitive cells • Suitable for microcarriers • Prevents sedimentation • Even at low speeds thorough mixing • Ø 211 mm, for 38 mm shaft • Spare part for bioreactors 	



To the Shop:



Alle / Verkaufsartikel / Accessories / Stirring and mixing / Special impeller designs

6-bladed angled impeller, Ø 64 mm, 10 mm shaft (45° angle)



bbi Scancode	BBI-43231151
Manufacturer	bbi-biotech GmbH
Material Certificate	3.1, Rauigkeit
Country of Origin	DE 
Material	Stainless steel 316L

Components	1x stirrer, 2x grub screw
Related Products	2 L Rushton impeller (BBI-43230324) 3-blade segment impeller, Ø 58 mm, 10 mm stirrer shaft (BBI-43230026) 6-bladed angled impeller, Ø 64 mm, 10 mm shaft (45° angle) (BBI-43231152)
<p>Description:</p> <ul style="list-style-type: none"> • Used for stirring in bioreactors • For shafts with diameter of 10 mm • Ø 64 mm 	



Alle / Verkaufsartikel / Accessories / Stirring and mixing / Special impeller designs

6-bladed angled impeller, Ø 64 mm, 10 mm shaft (45° angle)



bbi Scancode	BBI-43231152
Manufacturer	bbi-biotech GmbH
Material Certificate	3.1, Rauigkeit
Country of Origin	DE 
Material	Stainless steel 316L

Components	1x stirrer, 2x grub screw
Related Products	2-bladed paddle impeller, Ø 54 mm, 10 mm stirrer shaft (BBI-43230050) 5 L Rushton impeller (BBI-43230325) 6-bladed angled impeller, Ø 64 mm, 10 mm shaft (45° angle) (BBI-43231151)
Description: <ul style="list-style-type: none"> • Used for stirring in bioreactors • For shafts with diameter of 10 mm • Ø 64 mm 	



To the Shop:



Alle / Verkaufsartikel / Accessories / Stirring and mixing / Special impeller designs

Hollow Blade impeller, Ø 106 mm, 18 mm stirrer shaft



bbi Scancode	BBI-43231231
Manufacturer	bbi-biotech GmbH
Material Certificate	3.1, Rauigkeit
Country of Origin	DE 
Material	Stainless steel 316L

Components	1x stirrer, 2x grub screw
Related Products	10 L Rushton impeller (BBI-43230326) 6-bladed angled impeller, Ø 64 mm, 10 mm shaft (45° angle) (BBI-43231152) Hollow Blade impeller, Ø 131 mm, 18 mm stirrer shaft (BBI-43231232)
Description: <ul style="list-style-type: none"> • Used for stirring in bioreactors • For shafts with diameter of 18 mm • Ø 106 mm 	



To the Shop:



Alle / Verkaufsartikel / Accessories / Stirring and mixing / Special impeller designs

Hollow Blade impeller, Ø 131 mm, 18 mm stirrer shaft



bbi Scancode	BBI-43231232
Manufacturer	bbi-biotech GmbH
Material Certificate	3.1, Rauigkeit
Country of Origin	DE 
Material	Stainless steel 316L

Components	1x stirrer, 2x grub screw
Related Products	2-bladed paddle impeller, Ø 135 mm, 18 mm stirrer shaft (BBI-43230055) 3-blade segment impeller, Ø 130 mm, 18 mm stirrer shaft (BBI-43230013) Hollow Blade impeller, Ø 106 mm, 18 mm stirrer shaft (BBI-43231231)
Description: <ul style="list-style-type: none"> • Used for stirring in bioreactors • For shafts with diameter of 18 mm • Ø 131 mm 	



To the Shop:



Alle / Verkaufsartikel / Accessories / Stirring and mixing / Special impeller designs

Hollow Blade impeller, Ø 126 mm, 18 mm stirrer shaft



bbi Scancode	BBI-43231233
Manufacturer	bbi-biotech GmbH
Material Certificate	3.1, Rauigkeit
Country of Origin	DE 
Material	Stainless steel 316L

Components	1x stirrer, 2x grub screw
Related Products	30 L 3-bladed-segment impeller (BBI-43230715) Hollow Blade impeller, Ø 106 mm, 18 mm stirrer shaft (BBI-43231231) Hollow Blade impeller, Ø 131 mm, 18 mm stirrer shaft (BBI-43231232)
Description:	



To the Shop:



Alle / Verkaufsartikel / Accessories / Stirring and mixing / Special impeller designs

InterMIG impeller Ø 110 mm, 14 mm stirrer shaft



bbi Scancode	BBI-43231252
Manufacturer	bbi-biotech GmbH
Material Certificate	3.1, Rauigkeit
Country of Origin	DE 
Material	Stainless steel 316L

Components	1x stirrer, 2x grub screw
Related Products	2-bladed paddle impeller, Ø 109 mm, 14 mm stirrer shaft (BBI-43230053) 3-blade segment impeller, Ø 130 mm, 14 mm stirrer shaft (BBI-43230021) 5 L stirrer shaft, 14 mm (BBI-43230043)
Description: <ul style="list-style-type: none"> • Used for stirring in bioreactors • For shafts with diameter of 14 mm • Ø 110 mm 	



To the Shop:



Alle / Verkaufsartikel / Accessories / Stirring and mixing / Baffles & baffle cages

1 L baffle



bbi Scancode	BBI-43230031
Manufacturer	bbi-biotech GmbH
External Thread	M 10 x 1
Material Certificate	3.1, Rauigkeit, FDA
Country of Origin	DE 
HS-Code	84798200
Weight	0.13 kg
Material	Stainless steel 316L EPDM black

Components	1x baffle, 1x o-ring [BBI-45100011], 1x coupling nut M 10 x 1 (flat) [BBI-44130009]
Consumables	O-ring for items to install in 11 mm ports (package of 10 pieces) (BBI-45100011) Coupling nut M 10 x 1 (flat) (BBI-44130009)

Description:

- Flow resistance
- Improves mixing of medium at low stirring speeds and oxygen input
- Prevents the generation of fluid vortices at high stirring speeds
- 3 baffles on one ring
- Installation centered to the stirrer shaft
- Improved design: Prevents clogging between baffles and vessel wall
- Development by bbi-biotech
- Also available for other vessel sizes
- Similar to pictures shown
- Installation port: 11 mm



To the Shop:



Alle / Verkaufsartikel / Accessories / Stirring and mixing / Baffles & baffle cages

2 L baffle



bbi Scancode	BBI-43230032
Manufacturer	bbi-biotech GmbH
External Thread	M 10 x 1
Material Certificate	3.1, Rauigkeit, FDA
Country of Origin	DE 
HS-Code	84798200
Weight	0.18 kg
Material	Stainless steel 316L EPDM black

Components	1x baffle, 1x o-ring [BBI-45100011], 1x coupling nut M 10 x 1 (flat) [BBI-44130009]
Consumables	O-ring for items to install in 11 mm ports (package of 10 pieces) (BBI-45100011) Coupling nut M 10 x 1 (flat) (BBI-44130009)
Related Products	2 L Pt100 casing with baffle (BBI-43430013) 2 L baffle, single (BBI-43530097) 2 L ring sparger with baffle, downwards-facing holes with 0.8 mm (BBI-43530264)

Description:

- Flow resistance
- Improves mixing of medium at low stirring speeds and oxygen input
- Prevents the generation of fluid vortices at high stirring speeds
- 4 baffles on one ring
- Installation centered to the stirrer shaft
- Improved design: Prevents clogging between baffles and vessel wall
- Development by bbi-biotech
- Also available for other vessel sizes
- Similar to pictures shown
- Installation port: 11 mm



To the Shop:



Alle / Verkaufsartikel / Accessories / Stirring and mixing / Baffles & baffle cages

5 L baffle



bbi Scancode	BBI-43230033
Manufacturer	bbi-biotech GmbH
External Thread	M 10 x 1
Material Certificate	3.1, Rauigkeit, FDA
Country of Origin	DE 
HS-Code	84798200
Material	Stainless steel 316L EPDM black

Components	1x baffle, 2x o-ring [BBI-45100011], 2x coupling nut M 10 x 1 (flat) [BBI-44130009]
Consumables	O-ring for items to install in 11 mm ports (package of 10 pieces) (BBI-45100011) Coupling nut M 10 x 1 (flat) (BBI-44130009)
Related Products	5 L Pt100 casing with baffle (BBI-43430014) 5 L baffle, single (BBI-43530098) 5 L ring sparger with baffle, downwards-facing holes with 0.8 mm (BBI-43530265)

Description:

- Flow resistance
- Improves mixing of medium at low stirring speeds and oxygen input
- Prevents the generation of fluid vortices at high stirring speeds
- 4 baffles on one ring
- Installation centered to the stirrer shaft
- Improved design: Prevents clogging between baffles and vessel wall
- Development by bbi-biotech
- Also available for other vessel sizes
- Similar to pictures shown
- Installation port: 11 mm



To the Shop:



Alle / Verkaufsartikel / Accessories / Stirring and mixing / Baffles & baffle cages

10 L baffle



bbi Scancode	BBI-43230034
Manufacturer	bbi-biotech GmbH
External Thread	M 10 x 1
Material Certificate	3.1, Rauigkeit, FDA
Country of Origin	DE 
HS-Code	84798200
Weight	0.3 kg
Material	Stainless steel 316L EPDM black

Components	1x baffle, 2x o-ring [BBI-45100011], 2x coupling nut M 10 x 1 (flat) [BBI-44130009]
Consumables	O-ring for items to install in 11 mm ports (package of 10 pieces) (BBI-45100011) Coupling nut M 10 x 1 (flat) (BBI-44130009)
Related Products	10 L 3-bladed-segment impeller (BBI-43230306) 10 L baffle, single (BBI-43530094) 10 L ring sparger with chicane, downwards-facing holes with 0.8 mm (BBI-43530266)

Description:

- Flow resistance
- Improves mixing of medium at low stirring speeds and oxygen input
- Prevents the generation of fluid vortices at high stirring speeds
- 4 baffles on one ring
- Installation centered to the stirrer shaft
- Improved design: Prevents clogging between baffles and vessel wall
- Development by bbi-biotech
- Also available for other vessel sizes
- Similar to pictures shown
- Installation port: 11 mm



To the Shop:



Alle / Verkaufsartikel / Accessories / Stirring and mixing / Baffles & baffle cages

10 L baffle, single



bbi Scancode	BBI-43530094
Manufacturer	bbi-biotech GmbH
External Thread	M 10 x 1
Material Certificate	3.1, Rauigkeit, FDA
Country of Origin	DE 
HS-Code	84798200
Material	Stainless steel 316L EPDM black

Components	1x baffle, 1x O-ring [BBI-45100011], 1x coupling nut M 10 x 1 (flat) [BBI-44130009]
Related Products	10 L Pt100 casing with baffle (BBI-43430015) 10 L baffle (BBI-43230034) 10 L ring sparger with chicane, upwards-facing holes with 0.8 mm (BBI-43530272)

Description:

- Baffles enable an enhanced mixing of cells, nutrients, and gases
- Improved mass transfer and oxygen distribution
- Optimized microbial culture productivity
- Disruption of liquid flow for efficient nutrient distribution
- Increased turbulence leading to better microbial growth
- Baffles are also possible at pt100 empty sleeves, microspargers and other spare parts of a bioreactor or as a baffle baskets



Alle / Verkaufsartikel / Accessories / Stirring and mixing / Baffles & baffle cages

0.5 L baffle, single



bbi Scancode	BBI-43530095
Manufacturer	bbi-biotech GmbH
External Thread	M 10 x 1
Material Certificate	3.1, Rauigkeit, FDA
Country of Origin	DE 
HS-Code	84798200
Material	Stainless steel 316L EPDM black

Components	1x baffle, 1x O-ring [BBI-45100011], 1x coupling nut M 10 x 1 (flat) [BBI-44130009]
Related Products	0,5 L dip tube for harvesting, fix, with baffle, ID = 4 mm, M 10 x 1 (BBI-43630061) 0.5 L ring sparger with baffle, downwards-facing holes with 0.5 mm (BBI-43530241) 2 L dip tube for harvesting, fix, with baffle, ID = 4 mm, M 10 x 1 (BBI-43630063)

Description:

- Baffles enable an enhanced mixing of cells, nutrients, and gases
- Improved mass transfer and oxygen distribution
- Optimized microbial culture productivity
- Disruption of liquid flow for efficient nutrient distribution
- Increased turbulence leading to better microbial growth
- Baffles are also possible at pt100 empty sleeves, microspargers and other spare parts of a bioreactor or as a baffle baskets



To the Shop:



Alle / Verkaufsartikel / Accessories / Stirring and mixing / Baffles & baffle cages

1 L baffle, single



bbi Scancode	BBI-43530096
Manufacturer	bbi-biotech GmbH
External Thread	M 10 x 1
Material Certificate	3.1, Rauigkeit, FDA
Country of Origin	DE 
HS-Code	84798200
Material	Stainless steel 316L EPDM black

Components	1x baffle, 1x O-ring [BBI-45100011], 1x coupling nut M 10 x 1 (flat) [BBI-44130009]
-------------------	---

Description:

- Baffles enable an enhanced mixing of cells, nutrients, and gases
- Improved mass transfer and oxygen distribution
- Optimized microbial culture productivity
- Disruption of liquid flow for efficient nutrient distribution
- Increased turbulence leading to better microbial growth
- Baffles are also possible at pt100 empty sleeves, microspargers and other spare parts of a bioreactor or as a baffle baskets



Alle / Verkaufsartikel / Accessories / Stirring and mixing / Baffles & baffle cages

2 L baffle, single



bbi Scancode	BBI-43530097
Manufacturer	bbi-biotech GmbH
External Thread	M 10 x 1
Material Certificate	3.1, Rauigkeit, FDA
Country of Origin	DE 
HS-Code	84798200
Material	Stainless steel 316L EPDM black

Components	1x baffle, 1x O-ring [BBI-45100011], 1x coupling nut M 10 x 1 (flat) [BBI-44130009]
Related Products	2 L Pt100 casing with baffle (BBI-43430013) 2 L baffle (BBI-43230032) 2 L ring sparger with baffle, downwards-facing holes with 0.8 mm (BBI-43530264)

Description:

- Baffles enable an enhanced mixing of cells, nutrients, and gases
- Improved mass transfer and oxygen distribution
- Optimized microbial culture productivity
- Disruption of liquid flow for efficient nutrient distribution
- Increased turbulence leading to better microbial growth
- Baffles are also possible at pt100 empty sleeves, microspargers and other spare parts of a bioreactor or as a baffle baskets



Alle / Verkaufsartikel / Accessories / Stirring and mixing / Baffles & baffle cages

5 L baffle, single



bbi Scancode	BBI-43530098
Manufacturer	bbi-biotech GmbH
External Thread	M 10 x 1
Material Certificate	3.1, Rauigkeit, FDA
Country of Origin	DE 
HS-Code	84798200
Material	Stainless steel 316L EPDM black

Components	1x baffle, 1x O-ring [BBI-45100011], 1x coupling nut M 10 x 1 (flat) [BBI-44130009]
Related Products	5 L Pt100 casing with baffle (BBI-43430014) 5 L baffle (BBI-43230033) 5 L ring sparger with baffle, upwards-facing holes with 0.8 mm (BBI-43530271)

Description:

- Baffles enable an enhanced mixing of cells, nutrients, and gases
- Improved mass transfer and oxygen distribution
- Optimized microbial culture productivity
- Disruption of liquid flow for efficient nutrient distribution
- Increased turbulence leading to better microbial growth
- Baffles are also possible at pt100 empty sleeves, microspargers and other spare parts of a bioreactor or as a baffle baskets



Alle / Verkaufsartikel / Accessories / Probes and sensors / Level and antifoam probes

Antifoam or level probe L=80 mm



bbi Scancode	BBI-44630002
Manufacturer	bbi-biotech GmbH
Country of Origin	DE 
HS-Code	90261029
Weight	0.01 kg
Material	Stainless steel 316L EPDM black Ceramic Nylon

Components	1x probe
Consumables	O-Ring 3x1 (package of 10 pieces) (BBI-45100029)
Related Products	Adapter for 6 mm level probes or dip tubes for harvesting in 11 mm ports (BBI-44630103) Antifoam or level probe L=100 mm (BBI-44630003) Cable for antifoam or level probe (BBI-44630010)

Description:

- Level/antifoam probe with diameter 6 mm
- Length 80 mm
- Other lengths available
- Cable and adapter for installation in lid are available separately



To the Shop:



Alle / Verkaufsartikel / Accessories / Probes and sensors / Level and antifoam probes

Antifoam or level probe L=100 mm



bbi Scancode	BBI-44630003
Manufacturer	bbi-biotech GmbH
Country of Origin	DE 
HS-Code	90261029
Weight	0.02 kg
Material	Stainless steel 316L EPDM black Ceramic Nylon

Components	1x probe
Consumables	O-Ring 3x1 (package of 10 pieces) (BBI-45100029)
Related Products	Adapter for 6 mm level probes or dip tubes for harvesting in 11 mm ports (BBI-44630103) Antifoam or level probe L=80 mm (BBI-44630002) Cable for antifoam or level probe (BBI-44630010)

Description:

- Level/antifoam probe with diameter 6 mm
- Length 100 mm
- Other lengths available
- Cable and adapter for installation in lid are available separately



Alle / Verkaufsartikel / Accessories / Probes and sensors / Level and antifoam probes

Antifoam or level probe L=150 mm



bbi Scancode	BBI-44630004
Manufacturer	bbi-biotech GmbH
Country of Origin	DE 
HS-Code	90261029
Weight	0.02 kg
Material	Stainless steel 316L EPDM black Ceramic Nylon

Components	1x probe
Consumables	O-Ring 3x1 (package of 10 pieces) (BBI-45100029)
Related Products	Adapter for 6 mm level probes or dip tubes for harvesting in 11 mm ports (BBI-44630103) Antifoam or level probe L=100 mm (BBI-44630003) Cable for antifoam or level probe (BBI-44630010)

Description:

- Level/antifoam probe with diameter 6 mm
- Length 150 mm
- Other lengths available
- Cable and adapter for installation in lid are available separately



To the Shop:



Alle / Verkaufsartikel / Accessories / Probes and sensors / Level and antifoam probes

Antifoam or level probe L=250 mm



bbi Scancode	BBI-44630005
Manufacturer	bbi-biotech GmbH
Country of Origin	DE 
HS-Code	90261029
Weight	0.03 kg
Material	Stainless steel 316L EPDM black Ceramic Nylon

Components	1x probe
Consumables	O-Ring 3x1 (package of 10 pieces) (BBI-45100029)
Related Products	Adapter for 6 mm level probes or dip tubes for harvesting in Pg 13.5 ports (BBI-44630106) Antifoam or level probe L=150 mm (BBI-44630004) Cable for antifoam or level probe (BBI-44630010)

Description:

- Level/antifoam probe with diameter 6 mm
- Length 250 mm
- Other lengths available
- Cable and adapter for installation in lid are available separately



Alle / Verkaufsartikel / Accessories / Probes and sensors / Level and antifoam probes

Antifoam or level probe L=400 mm



bbi Scancode	BBI-44630006
Manufacturer	bbi-biotech GmbH
Country of Origin	DE 
HS-Code	90261029
Weight	0.05 kg
Material	Stainless steel 316L EPDM black Ceramic Nylon

Components	1x probe
Consumables	O-Ring 3x1 (package of 10 pieces) (BBI-45100029)
Related Products	Adapter for 6 mm level probes or dip tubes for harvesting in Rd 28 x 1/8 ports (BBI-44630102) Antifoam or level probe L=250 mm (BBI-44630005) Cable for antifoam or level probe (BBI-44630010)

Description:

- Level/antifoam probe with diameter 6 mm
- Length 400 mm
- Other lengths available
- Cable and adapter for installation in lid are available separately



To the Shop:



Alle / Verkaufsartikel / Accessories / Probes and sensors / Level and antifoam probes

Cable for antifoam or level probe



bbi Scancode	BBI-44630010
Manufacturer	bbi-biotech GmbH
Country of Origin	DE 
HS-Code	85444290
Weight	0.03 kg

Components	1x cable
Related Products	Antifoam or level probe L=100 mm (BBI-44630003) Antifoam or level probe L=250 mm (BBI-44630005) Antifoam or level probe L=400 mm (BBI-44630006)
Description: <ul style="list-style-type: none"> • For level/antifoam probe with diameter 6 mm • With 2 banana plugs • Length = 1 m 	



To the Shop:



Alle / Verkaufsartikel / Accessories / Probes and sensors / Level and antifoam probes

Cable for antifoam or level probe, 70 cm



bbi Scancode	BBI-44630011
Manufacturer	bbi-biotech GmbH
Country of Origin	DE 
HS-Code	85444290
Weight	0.02 kg

Components	1x cable
Related Products	Antifoam or level probe L=100 mm (BBI-44630003) Antifoam or level probe L=150 mm (BBI-44630004) Antifoam or level probe L=80 mm (BBI-44630002)
Description: <ul style="list-style-type: none"> • For level/antifoam probe with diameter 6 mm • With 2 banana plugs • Length = 0,7 m 	



To the Shop:



Alle / Verkaufsartikel / Accessories / Probes and sensors / Level and antifoam probes

Screw rosette for antifoam and level probe (package: 10 pieces)



bbi Scancode	BBI-44630012
Manufacturer	bbi-biotech GmbH
Country of Origin	UK
HS-Code	73181548
Material	Nylon

Components	10x screw rosette
Related Products	Antifoam or level probe L=100 mm (BBI-44630003) Antifoam or level probe L=80 mm (BBI-44630002) Cable for antifoam or level probe (BBI-44630010)
Description: <ul style="list-style-type: none"> • Spare part for level/antifoam probe with diameter 6 mm • In white 	



To the Shop:



Alle / Verkaufsartikel / Accessories / Probes and sensors / Redox probes

1 L Redox probe by Broadley James



bbi Scancode	BBI-44630215
Country of Origin	GB 

Components

Description:

Length = 120mm



To the Shop:



Alle / Verkaufsartikel / Accessories / Probes and sensors / Redox probes

2 L Redox probe by Broadley James



bbi Scancode	BBI-44630216
Country of Origin	GB 

Components

Description:

Length = 225mm



To the Shop:



Alle / Verkaufsartikel / Accessories / Probes and sensors / Redox probes

5 L Redox probe by Broadley James



bbi Scancode	BBI-44630217
Country of Origin	GB 

Components

Description:

Length = 325mm



To the Shop:



Alle / Verkaufsartikel / Accessories / Probes and sensors / Redox probes

10 L Redox probe by Broadley James



bbi Scancode	BBI-44630218
Country of Origin	GB 

Components

Description:

Length = 420 mm



To the Shop:



Alle / Verkaufsartikel / Accessories / Probes and sensors / Oxygen probes

Hamilton pO₂ probe classic for 0.5 L vessel - OxyFerm FDA 120 (120 mm with VP head)



bbi Scancode	BBI-44640300
Manufacturer	Hamilton

Components

Description:



To the Shop:



Alle / Verkaufsartikel / Accessories / Probes and sensors / Oxygen probes

Hamilton pO₂ probe classic for 1 L vessel - OxyFerm FDA 160 (160 mm with VP head)



bbi Scancode	BBI-44640301
Manufacturer	Hamilton

Components

Description:



To the Shop:



Alle / Verkaufsartikel / Accessories / Probes and sensors / Oxygen probes

Hamilton pO₂ probe classic for 2 L vessel - OxyFerm FDA 225 (225 mm with VP head)



bbi Scancode	BBI-44640302
Manufacturer	Hamilton
Weight	0,31 kg

Components

Description:



To the Shop:



Alle / Verkaufsartikel / Accessories / Probes and sensors / Oxygen probes

Hamilton pO₂ probe classic for 5 L vessel - OxyFerm FDA 325 (325 mm with VP head)



bbi Scancode	BBI-44640303
Manufacturer	Hamilton
Weight	0.43 kg

Components

Description:



To the Shop:



Alle / Verkaufsartikel / Accessories / Probes and sensors / Oxygen probes

Hamilton pO₂ probe classic for 10 L/15 L/20 L vessel - OxyFerm FDA 425 (425 mm with VP head)



bbi Scancode	BBI-44640304
Manufacturer	Hamilton

Components

Description:



To the Shop:



Alle / Verkaufsartikel / Accessories / Probes and sensors / Oxygen probes

Hamilton pO₂ probe classic for 0.5 L vessel - OxyFerm FDA 120 (120 mm with T82/D₄ head)



bbi Scancode	BBI-44640310
Manufacturer	Hamilton

Components

Description:



To the Shop:



Alle / Verkaufsartikel / Accessories / Probes and sensors / Oxygen probes

Hamilton pO₂ probe classic for 1 L vessel - OxyFerm FDA 160 (160 mm with T82/D₄ head)



bbi Scancode	BBI-44640311
Manufacturer	Hamilton

Components

Description:



To the Shop:



Alle / Verkaufsartikel / Accessories / Probes and sensors / Oxygen probes

Hamilton pO₂ probe classic for 2 L vessel - OxyFerm FDA 225 (225 mm with T82/D₄ head)



bbi Scancode	BBI-44640312
Manufacturer	Hamilton

Components

Description:



To the Shop:



Alle / Verkaufsartikel / Accessories / Probes and sensors / Oxygen probes

Hamilton pO₂ probe classic for 5 L vessel - OxyFerm FDA 325 (325 mm with T82/D₄ head)



bbi Scancode	BBI-44640313
Manufacturer	Hamilton

Components

Description:



To the Shop:



Alle / Verkaufsartikel / Accessories / Probes and sensors / Oxygen probes

Hamilton pO₂ probe classic for 10 L vessel - OxyFerm FDA 425 (425 mm with T82/D4 head)



bbi Scancode	BBI-44640314
Manufacturer	Hamilton

Components

Description:



To the Shop:



Alle / Verkaufsartikel / Accessories / Probes and sensors / Oxygen probes

Hamilton pO₂ probe optical for 0.5 L vessel - VisiFerm DO Arc 120 Ho (120 mm with VP head and cap Ho)



bbi Scancode	BBI-44640320
Manufacturer	Hamilton

Components

Description:



To the Shop:



Alle / Verkaufsartikel / Accessories / Probes and sensors / Oxygen probes

Hamilton pO₂ probe optical for 1 L vessel - VisiFerm DO Arc 120 Ho (160 mm with VP head and cap Ho)



bbi Scancode	BBI-44640321
Manufacturer	Hamilton

Components

Description:



To the Shop:



Alle / Verkaufsartikel / Accessories / Probes and sensors / Oxygen probes

Hamilton pO₂ probe optical for 2 L vessel - VisiFerm DO Arc 225 Ho (225 mm with VP head and cap Ho)



bbi Scancode	BBI-44640322
Manufacturer	Hamilton

Components

Description:



To the Shop:



Alle / Verkaufsartikel / Accessories / Probes and sensors / Oxygen probes

Hamilton pO₂ probe optical for 5 L vessel - VisiFerm DO Arc 325 Ho (325 mm with VP head and cap Ho)



bbi Scancode	BBI-44640323
Manufacturer	Hamilton

Components

Description:



To the Shop:



Alle / Verkaufsartikel / Accessories / Probes and sensors / Oxygen probes

Hamilton pO₂ probe optical for 10 L vessel - VisiFerm DO Arc 425 Ho (425 mm with VP head and cap Ho)



bbi Scancode	BBI-44640324
Manufacturer	Hamilton

Components

Description:



To the Shop:



Alle / Verkaufsartikel / Accessories / Probes and sensors / Oxygen probes

Hamilton pO₂ probe optical for 0.5 L vessel - VisiFerm DO Arc 120 H₂ (120 mm with VP head and cap H₂)



bbi Scancode	BBI-44640330
Manufacturer	Hamilton

Components	
Description:	



To the Shop:



Alle / Verkaufsartikel / Accessories / Probes and sensors / Oxygen probes

Hamilton pO₂ probe optical for 1 L vessel - VisiFerm DO Arc 160 H₂ (160 mm with VP head and cap H₂)



bbi Scancode	BBI-44640331
Manufacturer	Hamilton

Components

Description:



To the Shop:



Alle / Verkaufsartikel / Accessories / Probes and sensors / Oxygen probes

Hamilton pO₂ probe optical for 2 L vessel - VisiFerm DO Arc 225 H₂ (225 mm with VP head and cap H₂)



bbi Scancode	BBI-44640332
Manufacturer	Hamilton

Components

Description:



To the Shop:



Alle / Verkaufsartikel / Accessories / Probes and sensors / Oxygen probes

Hamilton pO₂ probe optical for 5 L vessel - VisiFerm DO Arc 325 H₂ (325 mm with VP head and cap H₂)



bbi Scancode	BBI-44640333
Manufacturer	Hamilton

Components

Description:



To the Shop:



Alle / Verkaufsartikel / Accessories / Probes and sensors / Oxygen probes

Hamilton pO₂ probe optical for 10 L vessel - VisiFerm DO Arc 425 H₂ (425 mm with VP head and cap H₂)



bbi Scancode	BBI-44640334
Manufacturer	Hamilton

Components

Description:



To the Shop:



Alle / Verkaufsartikel / Accessories / Probes and sensors / Probe cables

pH cable K8 / DIN, 1 m



bbi Scancode	BBI-44630209
Manufacturer	bbi-biotech GmbH
HS-Code	0

Components	
Related Products	Sensor cable T82/D4 / Lemo for pO ₂ probes, 1 m (BBI-44630210) pH cable K8 / DIN, 2m (BBI-44630219) pH cable K8 / DIN, 3 m (BBI-44630213)
Description:	



To the Shop:



Alle / Verkaufsartikel / Accessories / Probes and sensors / Probe cables

Sensor cable T82/D4 / Lemo for pO₂ probes, 1 m



bbi Scancode	BBI-44630210
Manufacturer	bbi-biotech GmbH
HS-Code	0

Components	
Related Products	Probe cable VP/VP for standard pH and pO ₂ probes, 1 m (BBI-44640904) Sensor cable T82/D4 / Lemo for pO ₂ probes, 2m (BBI-44630212) Sensor cable T82/D4 / Lemo for pO ₂ probes, 3 m (BBI-44630214)
Description:	



To the Shop:



Alle / Verkaufsartikel / Accessories / Probes and sensors / Probe cables

Sensor cable T82/D4 / Lemo for pO₂ probes, 2m



bbi Scancode	BBI-44630212
Manufacturer	bbi-biotech GmbH
HS-Code	0

Components	
Related Products	Probe cable VP/VP for standard pH and pO ₂ probes, 5 m (BBI-44640905) Sensor cable T82/D4 / Lemo for pO ₂ probes, 1 m (BBI-44630210) Sensor cable T82/D4 / Lemo for pO ₂ probes, 3 m (BBI-44630214)
Description:	



To the Shop:



Alle / Verkaufsartikel / Accessories / Probes and sensors / Probe cables

pH cable K8 / DIN, 3 m



bbi Scancode	BBI-44630213
Manufacturer	bbi-biotech GmbH
Country of Origin	GB 
HS-Code	0

Components	
Related Products	Sensor cable T82/D4 / Lemo for pO ₂ probes, 3 m (BBI-44630214) pH cable K8 / DIN, 1 m (BBI-44630209) pH cable K8 / DIN, 2m (BBI-44630219)
Description:	



To the Shop:



Alle / Verkaufsartikel / Accessories / Probes and sensors / Probe cables

Sensor cable T82/D4 / Lemo for pO₂ probes, 3 m



bbi Scancode	BBI-44630214
Manufacturer	bbi-biotech GmbH
HS-Code	0

Components	
Related Products	Probe cable VP/VP for standard pH and pO ₂ probes, 1 m (BBI-44640904) Sensor cable T82/D4 / Lemo for pO ₂ probes, 1 m (BBI-44630210) Sensor cable T82/D4 / Lemo for pO ₂ probes, 2m (BBI-44630212)
Description:	



To the Shop:



Alle / Verkaufsartikel / Accessories / Probes and sensors / Probe cables

pH cable K8 / DIN, 2m



bbi Scancode	BBI-44630219
Manufacturer	bbi-biotech GmbH
HS-Code	0

Components	
Related Products	<p>Sensor cable T82/D4 / Lemo for pO₂ probes, 2m (BBI-44630212)</p> <p>pH cable K8 / DIN, 1 m (BBI-44630209)</p> <p>pH cable K8 / DIN, 3 m (BBI-44630213)</p>
Description:	



To the Shop:



Alle / Verkaufsartikel / Accessories / Probes and sensors / Probe cables

Adapter probe cable VP/K8 for pH and pO₂ probes with VP head and K8 plug at controller, 1m



bbi Scancode	BBI-44640900
Manufacturer	bbi-biotech GmbH
Country of Origin	DE 

Components

Description:



To the Shop:



Alle / Verkaufsartikel / Accessories / Probes and sensors / Probe cables

Probe cable VP/VP for standard pH and pO₂ probes, 2m



bbi Scancode	BBI-44640901
Manufacturer	bbi-biotech GmbH
Country of Origin	EU 
HS-Code	85444290
Weight	0.28 kg

Related Products

Probe cable VP/M8 for pH and pO₂ probes, 2 m (BBI-44640906)
 Probe cable VP/VP for standard pH and pO₂ probes, 5 m (BBI-44640905)
 Sensor cable T82/D4 / Lemo for pO₂ probes, 2m (BBI-44630212)

Description:



To the Shop:



Alle / Verkaufsartikel / Accessories / Probes and sensors / Probe cables

Adapter probe cable VP/K8 for pH and pO₂ probes with VP head and K8 plug at controller, 3m



bbi Scancode	BBI-44640902
Manufacturer	bbi-biotech GmbH
Country of Origin	DE 

Components

Description:



To the Shop:



Alle / Verkaufsartikel / Accessories / Probes and sensors / Probe cables

Probe cable VP/VP for standard pH and pO₂ probes, 70 cm



bbi Scancode	BBI-44640903
Manufacturer	bbi-biotech GmbH
Country of Origin	EU ●
HS-Code	85444290
Weight	0.17 kg

Related Products	<p>Probe cable VP/M8 for pH and pO₂ probes, 2 m (BBI-44640906)</p> <p>Probe cable VP/VP for standard pH and pO₂ probes, 5 m (BBI-44640905)</p> <p>Sensor cable T82/D4 / Lemo for pO₂ probes, 1 m (BBI-44630210)</p>
Description:	



Alle / Verkaufsartikel / Accessories / Probes and sensors / Probe cables

Probe cable VP/VP for standard pH and pO₂ probes, 1 m



bbi Scancode	BBI-44640904
Manufacturer	bbi-biotech GmbH
Country of Origin	EU 
HS-Code	85444290
Weight	0.2 kg

Related Products

Probe cable VP/M8 for pH and pO₂ probes, 2 m (BBI-44640906)
 Probe cable VP/VP for standard pH and pO₂ probes, 5 m (BBI-44640905)
 Sensor cable T82/D4 / Lemo for pO₂ probes, 2m (BBI-44630212)

Description:



To the Shop:



Alle / Verkaufsartikel / Accessories / Probes and sensors / Probe cables

Probe cable VP/VP for standard pH and pO₂ probes, 5 m



bbi Scancode	BBI-44640905
Manufacturer	bbi-biotech GmbH
Country of Origin	EU 
HS-Code	85444290

Related Products

Probe cable VP/VP for standard pH and pO₂ probes, 1 m (BBI-44640904)
 Sensor cable T82/D4 / Lemo for pO₂ probes, 1 m (BBI-44630210)
 Sensor cable T82/D4 / Lemo for pO₂ probes, 3 m (BBI-44630214)

Description:



To the Shop:



Alle / Verkaufsartikel / Accessories / Probes and sensors / Probe cables

Probe cable VP/M8 for pH and pO₂ probes, 2 m



bbi Scancode	BBI-44640906
Manufacturer	bbi-biotech GmbH
HS-Code	85444290

Related Products

Adapter probe cable VP/K8 for pH and pO₂ probes with VP head and K8 plug at controller, 1m (BBI-44640900)
 Probe cable VP/VP for standard pH and pO₂ probes, 1 m (BBI-44640904)
 Sensor cable T82/D4 / Lemo for pO₂ probes, 2m (BBI-44630212)

Description:



To the Shop:



Alle / Verkaufsartikel / Accessories / Probes and sensors / Other probes

Hamilton conductivity probe Conducell 4USF VP 120 1 $\mu\text{S}/\text{cm}$ to 500 mS/cm (120 mm with VP head)



bbi Scancode	BBI-44640400
Manufacturer	Hamilton

Components

Description:



To the Shop:



Alle / Verkaufsartikel / Accessories / Probes and sensors / Other probes

Hamilton conductivity probe Conducell UPW PG 13.5 - 0.02 to 2000 $\mu\text{S}/\text{cm}$ (120 mm with VP head)



bbi Scancode	BBI-44640401
Manufacturer	Hamilton

Components

Description:



To the Shop:



Alle / Verkaufsartikel / Accessories / Probes and sensors / Other probes

Glucose sensor including tubing set



bbi Scancode	BBI-44640701
Manufacturer	bbi-biotech GmbH
Country of Origin	DE 
Weight	0.07 kg

Components

Description:



To the Shop:



Alle / Verkaufsartikel / Accessories / Probes and sensors / pH probes

Hamilton pH probe classic for 0.5 L vessel EasyFerm Plus PHI K8 120 (120 mm with K8 head)



bbi Scancode	BBI-44631200
Manufacturer	Hamilton
HS-Code	0

Components

Description:



To the Shop:



Alle / Verkaufsartikel / Accessories / Probes and sensors / pH probes

Hamilton pH probe classic for 1 L vessel EasyFerm Plus PHI K8 160 (160 mm with K8 head)



bbi Scancode	BBI-44631201
Manufacturer	Hamilton

Components

Description:



To the Shop:



Alle / Verkaufsartikel / Accessories / Probes and sensors / pH probes

Hamilton pH probe classic for 2 L vessel EasyFerm Plus PHI K8 225 (225 mm with K8 head)



bbi Scancode	BBI-44631202
Manufacturer	Hamilton

Components

Description:



To the Shop:



Alle / Verkaufsartikel / Accessories / Probes and sensors / pH probes

Hamilton pH probe classic for 5 L vessel EasyFerm Plus PHI K8 325 (325 mm with K8 head)



bbi Scancode	BBI-44631203
Manufacturer	Hamilton

Components

Description:



To the Shop:



Alle / Verkaufsartikel / Accessories / Probes and sensors / pH probes

Hamilton pH probe classic for 10 L vessel EasyFerm Plus PHI K8 425 (425 mm with K8 head)



bbi Scancode	BBI-44631204
Manufacturer	Hamilton
HS-Code	0

Description:



To the Shop:



Alle / Verkaufsartikel / Accessories / Probes and sensors / pH probes

Hamilton pH probe classic for 0.5 L vessel - EasyFerm Plus PHI VP 120 (120 mm, VP connector)



bbi Scancode	BBI-44640200
Manufacturer	Hamilton

Description:



To the Shop:



Alle / Verkaufsartikel / Accessories / Probes and sensors / pH probes

Hamilton pH probe classic for 1 L vessel - EasyFerm Plus PHI VP 160 (160 mm, VP connector)



bbi Scancode	BBI-44640201
Manufacturer	Hamilton

Description:



To the Shop:



Alle / Verkaufsartikel / Accessories / Probes and sensors / pH probes

Hamilton pH probe classic for 2 L vessel - EasyFerm Plus PHI VP 225 (225 mm, VP connector)



bbi Scancode	BBI-44640202
Manufacturer	Hamilton

Description:



To the Shop:



Alle / Verkaufsartikel / Accessories / Probes and sensors / pH probes

Hamilton pH probe classic for 5 L vessel - EasyFerm Plus PHI VP 325 (325 mm, VP connector)



bbi Scancode	BBI-44640203
Manufacturer	Hamilton

Description:



To the Shop:



Alle / Verkaufsartikel / Accessories / Probes and sensors / pH probes

Hamilton pH probe classic for 10 L vessel - EasyFerm Plus PHI VP 425 (425 mm, VP connector)



bbi Scancode	BBI-44640204
Manufacturer	Hamilton

Description:



To the Shop:



Alle / Verkaufsartikel / Accessories / Temperature control / Heating jackets

10 L heating jacket, 230 VAC



bbi Scancode	BBI-43430100
Manufacturer	bbi-biotech GmbH
Country of Origin	DE 
HS-Code	85168020

Components	1x heating jacket incl. power cord
Related Products	10 L heating jacket, 24 V, 180 W (BBI-43430205) 10 L single-walled glass vessel (BBI-44430304) 10 L vessel SW complete with standard accessories CC without sensors and heating jacket (BBI-44437100)
Description: _xooD_ <ul style="list-style-type: none"> • Electrical heating jacket for single-walled vessels _xooD_	



To the Shop:



Alle / Verkaufsartikel / Accessories / Temperature control / Heating jackets

1 L heating jacket, 120 VAC



bbi Scancode	BBI-43430101
Manufacturer	bbi-biotech GmbH
Country of Origin	DE 
HS-Code	85168020

Components

1x heating jacket incl. power cord

Description:

- _x000D_
- Electrical heating jacket for single-walled vessels
- _x000D_



To the Shop:



Alle / Verkaufsartikel / Accessories / Temperature control / Heating jackets

1 L heating jacket, 230 VAC



bbi Scancode	BBI-43430102
Manufacturer	bbi-biotech GmbH
Country of Origin	DE 
HS-Code	85168020

Components

1x heating jacket incl. power cord

Description:

- _x000D_
- Electrical heating jacket for single-walled vessels
- _x000D_



To the Shop:



Alle / Verkaufsartikel / Accessories / Temperature control / Heating jackets

2 L heating jacket, 120 VAC



bbi Scancode	BBI-43430103
Manufacturer	bbi-biotech GmbH
Country of Origin	DE 
HS-Code	85168020

Components	1x heating jacket incl. power cord
Related Products	2 L heating jacket, 230 VAC (BBI-43430104) 2 L heating jacket, 24 V, 180 W (BBI-43430203) 2 L single-walled glass vessel (BBI-44430302)
Description: _xooD_ <ul style="list-style-type: none"> Electrical heating jacket for single-walled vessels _xooD_	



To the Shop:



Alle / Verkaufsartikel / Accessories / Temperature control / Heating jackets

2 L heating jacket, 230 VAC



bbi Scancode	BBI-43430104
Manufacturer	bbi-biotech GmbH
Country of Origin	DE 
HS-Code	85168020

Components	1x heating jacket incl. power cord
Related Products	2 L heating jacket, 120 VAC (BBI-43430103) 2 L heating jacket, 24 V, 180 W (BBI-43430203) 2 L single-walled glass vessel (BBI-44430302)
Description: _xooD_ <ul style="list-style-type: none"> Electrical heating jacket for single-walled vessels _xooD_	



To the Shop:



Alle / Verkaufsartikel / Accessories / Temperature control / Heating jackets

5 L heating jacket, 120 VAC



bbi Scancode	BBI-43430105
Manufacturer	bbi-biotech GmbH
Country of Origin	DE 
HS-Code	85168020

Components	1x heating jacket incl. power cord
Related Products	5 L heating jacket, 230 VAC (BBI-43430106) 5 L heating jacket, 24 V, 180 W (BBI-43430204) 5 L single-walled glass vessel (BBI-44430303)
Description: _xooD_ <ul style="list-style-type: none"> Electrical heating jacket for single-walled vessels _xooD_	



To the Shop:



Alle / Verkaufsartikel / Accessories / Temperature control / Heating jackets

5 L heating jacket, 230 VAC



bbi Scancode	BBI-43430106
Manufacturer	bbi-biotech GmbH
Country of Origin	DE 
HS-Code	85168020

Components	1x heating jacket incl. power cord
Related Products	5 L heating jacket, 120 VAC (BBI-43430105) 5 L heating jacket, 24 V, 180 W (BBI-43430204) 5 L single-walled glass vessel (BBI-44430303)
Description: _xooD_ <ul style="list-style-type: none"> Electrical heating jacket for single-walled vessels _xooD_	



To the Shop:



Alle / Verkaufsartikel / Accessories / Temperature control / Heating jackets

0.25 L heating jacket, 24 V, 180 W



bbi Scancode	BBI-43430200
Manufacturer	bbi-biotech GmbH
Country of Origin	DE 
HS-Code	85168020

Components	1x heating jacket incl. power cord
Related Products	0,25 L lid (BBI-44430352) 0.25 L exhaust cooler (to weld) (BBI-43930013) 0.25 L single-walled glass vessel (BBI-44430299)
Description: _xooD_ <ul style="list-style-type: none"> • Electrical heating jacket for single-walled vessels _xooD_	



To the Shop:



Alle / Verkaufsartikel / Accessories / Temperature control / Heating jackets

0.5 L heating jacket, 24 V, 180 W



bbi Scancode	BBI-43430201
Manufacturer	bbi-biotech GmbH
Country of Origin	DE 
HS-Code	85168020

Components	1x heating jacket incl. power cord
Related Products	0.5 L single-walled glass vessel (BBI-44430300) 2 L heating jacket, 24 V, 180 W (BBI-43430203) 5 L heating jacket, 24 V, 180 W (BBI-43430204)
Description: <ul style="list-style-type: none"> • Electrical heating jacket for single-walled vessels 	



To the Shop:



Alle / Verkaufsartikel / Accessories / Temperature control / Heating jackets

1 L heating jacket, 24 V, 180 W



bbi Scancode	BBI-43430202
Manufacturer	bbi-biotech GmbH
Country of Origin	DE 
HS-Code	85168020

Components	1x heating jacket incl. power cord
Description: <ul style="list-style-type: none"> • Electrical heating jacket for single-walled vessels 	



To the Shop:



Alle / Verkaufsartikel / Accessories / Temperature control / Heating jackets

2 L heating jacket, 24 V, 180 W



bbi Scancode	BBI-43430203
Manufacturer	bbi-biotech GmbH
Country of Origin	DE 
HS-Code	85168020
Weight	0.4 kg

Components	1x heating jacket incl. power cord
Related Products	2 L heating jacket, 120 VAC (BBI-43430103) 2 L heating jacket, 230 VAC (BBI-43430104) 2 L single-walled glass vessel (BBI-44430302)
Description: <ul style="list-style-type: none"> • Silicone heating mat with viewing hole for glass vessel • Dimensions: 150 x 440 mm • M 16 connector 	



To the Shop:



Alle / Verkaufsartikel / Accessories / Temperature control / Heating jackets

5 L heating jacket, 24 V, 180 W



bbi Scancode	BBI-43430204
Manufacturer	bbi-biotech GmbH
Country of Origin	DE 
HS-Code	85168020
Weight	0.8 kg

Components	1x heating jacket incl. power cord
Related Products	5 L heating jacket, 120 VAC (BBI-43430105) 5 L heating jacket, 230 VAC (BBI-43430106) 5 L single-walled glass vessel (BBI-44430303)
Description: <ul style="list-style-type: none"> • Silicone heating mat with viewing hole for glass vessel • Dimensions: 250 x 534 mm • M 16 connector 	



To the Shop:



Alle / Verkaufsartikel / Accessories / Temperature control / Heating jackets

10 L heating jacket, 24 V, 180 W



bbi Scancode	BBI-43430205
Manufacturer	bbi-biotech GmbH
Country of Origin	DE 
HS-Code	85168020
Weight	1.3 kg

Components	1x heating jacket incl. power cord
Related Products	10 L heating jacket, 230 VAC (BBI-43430100) 10 L single-walled glass vessel (BBI-44430304) 10 L vessel SW complete with standard accessories CC without sensors and heating jacket (BBI-44437100)
Description: <ul style="list-style-type: none"> • Silicone heating mat with viewing hole for glass vessel • Dimensions: 350 x 628 mm • M 16 connector 	



To the Shop:



Alle / Verkaufsartikel / Accessories / Temperature control / Heating jackets

bbi heating jacket for Eppendorf 10 L BioBlu, 24V/180W



bbi Scancode	BBI-43430251
Manufacturer	bbi-biotech GmbH
Country of Origin	DE 
Weight	1.3 kg

Components	1x heating jacket incl. power cord
Related Products	1 L heating jacket, 24 V, 180 W (BBI-43430202) bbi Heating jacket for Applikon 3 L SW, 24V/180W (BBI-43430252) bbi Heating jacket for Moebius 3 L single-use vessel, 24V/180W (BBI-43430253)
Description: <ul style="list-style-type: none"> • Silicone heating mat trapezoidal • Dimensions: 350 mm high • M 16 connector 	



To the Shop:



Alle / Verkaufsartikel / Accessories / Temperature control / Heating jackets

bbi Heating jacket for Applikon 3 L SW, 24V/180W



bbi Scancode	BBI-43430252
Manufacturer	bbi-biotech GmbH
Country of Origin	DE 
Weight	0.6 kg

Components	1x heating jacket incl. power cord
Related Products	10 L heating jacket, 230 VAC (BBI-43430100) bbi Heating jacket for Moebius 3 L single-use vessel, 24V/180W (BBI-43430253) bbi heating jacket for Eppendorf 10 L BioBlu, 24V/180W (BBI-43430251)
Description: <ul style="list-style-type: none"> • Silicone heating mat with viewing hole for glass vessel • M 16 connector 	



To the Shop:



Alle / Verkaufsartikel / Accessories / Temperature control / Heating jackets

bbi Heating jacket for Moebius 3 L single-use vessel, 24V/180W



bbi Scancode	BBI-43430253
Manufacturer	bbi-biotech GmbH
Country of Origin	DE 
Weight	0.8 kg

Components	1x heating jacket incl. power cord
Related Products	2 L heating jacket, 230 VAC (BBI-43430104) bbi Heating jacket for Applikon 3 L SW, 24V/180W (BBI-43430252) bbi heating jacket for Eppendorf 10 L BioBlu, 24V/180W (BBI-43430251)
Description: <ul style="list-style-type: none"> • Silicone heating mat with viewing hole for glass vessel and further cur-outs • Dimensions: 210 x 416 mm 	



To the Shop:



Alle / Verkaufsartikel / Accessories / Temperature control / Heating jackets

1 L heating jacket, 230 VAC, 180 W, for DW vessel



bbi Scancode

BBI-43430254

Components	1x heating jacket incl. power cable
Related Products	0.5 L heating jacket, 24 V, 180 W (BBI-43430201) 1 L heating jacket, 120 VAC (BBI-43430101) 10 L heating jacket, 24 V, 180 W (BBI-43430205)
Description:	



To the Shop:



Alle / Verkaufsartikel / Accessories / Temperature control / Heating jackets

bbi heating jacket for Eppendorf 50 L BioBlu, 24V/180W



bbi Scancode	BBI-43430255
Manufacturer	bbi-biotech GmbH
Country of Origin	DE 

Components	1x heating jacket incl. power cord
Related Products	bbi Heating jacket for Applikon 3 L SW, 24V/180W (BBI-43430252) bbi Heating jacket for Moebius 3 L single-use vessel, 24V/180W (BBI-43430253) bbi heating jacket for Eppendorf 10 L BioBlu, 24V/180W (BBI-43430251)
Description:	



To the Shop:



Alle / Verkaufsartikel / Accessories / Temperature control / Cooling fingers

1 L cooling finger



bbi Scancode	BBI-43430302
Manufacturer	bbi-biotech GmbH
External Thread	M 26 x 1
Material Certificate	3.1, Rauigkeit
Country of Origin	DE 
Material	Stainless steel 316L EPDM black

Components

1x cooling finger, 2x connections

Description:

- Cooling fingers are used to cool single-walled culture vessels
- The cooling water can be supplied via the temperature control of the bioreactor
- Direct connection to separate cooling units is also possible



To the Shop:



Alle / Verkaufsartikel / Accessories / Temperature control / Cooling fingers

2 L cooling finger



bbi Scancode	BBI-43430303
Manufacturer	bbi-biotech GmbH
External Thread	M 26 x 1
Material Certificate	3.1, Rauigkeit
Country of Origin	DE 
Material	Stainless steel 316L EPDM black

Components	1x cooling finger, 2x connections
Related Products	2 L Pt100 casing (BBI-43430004) 2 L single-walled glass vessel (BBI-44430302) 5 L cooling finger (BBI-43430304)
<p>Description:</p> <ul style="list-style-type: none"> • Cooling fingers are used to cool single-walled culture vessels • The cooling water can be supplied via the temperature control of the bioreactor • Direct connection to separate cooling units is also possible 	



Alle / Verkaufsartikel / Accessories / Temperature control / Cooling fingers

5 L cooling finger



bbi Scancode	BBI-43430304
Manufacturer	bbi-biotech GmbH
External Thread	M 26 x 1
Material Certificate	3.1, Rauigkeit
Country of Origin	DE 
Material	Stainless steel 316L EPDM black

Components	1x cooling finger, 2x connections
Related Products	2 L cooling finger (BBI-43430303) 5 L Pt100 casing (BBI-43430005) Temperature sensor Pt100, 1 m (BBI-43430020)

Description:

- Cooling fingers are used to cool single-walled culture vessels
- The cooling water can be supplied via the temperature control of the bioreactor
- Direct connection to separate cooling units is also possible



Alle / Verkaufsartikel / Accessories / Temperature control / Cooling fingers

10 L cooling finger



bbi Scancode	BBI-43430305
Manufacturer	bbi-biotech GmbH
External Thread	M 26 x 1
Material Certificate	3.1, Rauigkeit
Country of Origin	DE 
Material	Stainless steel 316L EPDM black

Components	1x cooling finger, 2x connections
Related Products	10 L heating jacket, 24 V, 180 W (BBI-43430205) 10 L single-walled glass vessel (BBI-44430304) 5 L cooling finger (BBI-43430304)
<p>Description:</p> <ul style="list-style-type: none"> • Cooling fingers are used to cool single-walled culture vessels • The cooling water can be supplied via the temperature control of the bioreactor • Direct connection to separate cooling units is also possible 	



Alle / Verkaufsartikel / Accessories / Temperature control / Plate heat exchanger

Plate heat exchanger



bbi Scancode	BBI-44131100
Internal Thread	4x3/4"
HS-Code	84195080

Components	1x plate heat exchanger
Related Products	Plate heat exchanger (BBI-44131103) Plate heat exchanger (BBI-44131102) Plate heat exchanger (BBI-44131101)
Description: <ul style="list-style-type: none"> • 20 plates • 0,24m² • connection 4x3/4" 	



To the Shop:



Alle / Verkaufsartikel / Accessories / Temperature control / Plate heat exchanger

Plate heat exchanger



bbi Scancode

BBI-44131101

Components	
Related Products	Plate heat exchanger (BBI-44131103) Plate heat exchanger (BBI-44131100) Plate heat exchanger (BBI-44131102)
Description: 30 Platten, 0,34m ² , Anschluss 4x3/4"	



To the Shop:



Alle / Verkaufsartikel / Accessories / Temperature control / Plate heat exchanger

Plate heat exchanger



bbi Scancode

BBI-44131102

Components	
Related Products	<ul style="list-style-type: none"> Plate heat exchanger (BBI-44131103) Plate heat exchanger (BBI-44131100) Plate heat exchanger (BBI-44131101)
Description: 30 Platten, 0,41m ² , Anschluss 4 x 3/4"	



To the Shop:



Alle / Verkaufsartikel / Accessories / Temperature control / Plate heat exchanger

Plate heat exchanger



bbi Scancode	BBI-44131103
Internal Thread	4x1"
Country of Origin	CN 
HS-Code	84195080
Weight	6.2 kg
Material	stainless steel

Components	1x plate heat exchanger
Related Products	<p>Plate heat exchanger (BBI-44131100)</p> <p>Plate heat exchanger (BBI-44131101)</p> <p>Plate heat exchanger (BBI-44131102)</p>
<p>Description:</p> <ul style="list-style-type: none"> • 40 plates • 1,22 m² • Connection 4x1" 	



Alle / Verkaufsartikel / Accessories / Temperature control / Pt100 casings

0,25 L Pt100 sleeve



bbi Scancode	BBI-43430000
Manufacturer	bbi-biotech GmbH
Installation Depth	125 mm
Material Certificate	3.1, Rauigkeit, FDA
Material	Stainless steel 316L

Components	1x empty tube
Related Products	0,25 L lid (BBI-44430352) 0.25 L jacketed glass vessel (BBI-44430054) Temperature sensor Pt100, 1 m (BBI-43430020)
Description: <ul style="list-style-type: none"> • For welding to the lid of the bioreactor • Fitting to install PT100 probes • Casing without probe 	



To the Shop:



Alle / Verkaufsartikel / Accessories / Temperature control / Pt100 casings

2 L Pt100 casing



bbi Scancode	BBI-43430004
Manufacturer	bbi-biotech GmbH
External Thread	M 10 x 1
Installation Depth	217 mm
Material Certificate	3.1, Rauigkeit, FDA
Country of Origin	DE 
HS-Code	73269098
Weight	0.06 kg
Material	Stainless steel 316L EPDM black PTFE

Components	1x empty tube, 1x o-ring [BBI-45100011], 1x coupling nut M 10 x 1 (flat) [BBI-44130009], 1x coupling nut M 10x1 (high) [BBI-44130010], 1x clamping cone [BBI-44130017]
Consumables	O-ring for items to install in 11 mm ports (package of 10 pieces) (BBI-45100011) Clamping cone (Package of 5 pieces) (BBI-44130017)
Related Products	2 L Pt100 casing with baffle (BBI-43430013) 2 L aeration basket (BBI-43530101) Temperature sensor Pt100, 1 m (BBI-43430020)

Description:

- For use with bioreactors
- Fitting to install PT100 probes
- Casing without probe



To the Shop:



Alle / Verkaufsartikel / Accessories / Temperature control / Pt100 casings

5 L Pt100 casing



bbi Scancode	BBI-43430005
Manufacturer	bbi-biotech GmbH
External Thread	M 10 x 1
Installation Depth	317 mm
Material Certificate	3.1, Rauigkeit, FDA
Country of Origin	DE 
HS-Code	73269098
Weight	0.07 kg
Material	Stainless steel 316L EPDM black PTFE

Components	1x empty tube, 1x o-ring [BBI-45100011], 1x coupling nut M 10 x 1 (flat) [BBI-44130009], 1x coupling nut M 10x1 (high) [BBI-44130010], 1x clamping cone [BBI-44130017]
Consumables	O-ring for items to install in 11 mm ports (package of 10 pieces) (BBI-45100011) Clamping cone (Package of 5 pieces) (BBI-44130017)
Related Products	5 L Pt100 casing with baffle (BBI-43430014) Temperature sensor Pt100, 1 m (BBI-43430020) Temperature sensor Pt100, 3 m (BBI-43430023)

Description:

- For use with bioreactors
- Fitting to install PT100 probes
- Casing without probe



To the Shop:



Alle / Verkaufsartikel / Accessories / Temperature control / Pt100 casings

10 L Pt100 casing



bbi Scancode	BBI-43430006
Manufacturer	bbi-biotech GmbH
External Thread	M 10 x 1
Installation Depth	417 mm
Material Certificate	3.1, Rauigkeit, FDA
Country of Origin	DE 
HS-Code	73269098
Weight	0.09 kg
Material	Stainless steel 316L EPDM black PTFE

Components	1x empty tube, 1x o-ring [BBI-45100011], 1x coupling nut M 10 x 1 (flat) [BBI-44130009], 1x coupling nut M 10x1 (high) [BBI-44130010], 1x clamping cone [BBI-44130017]
Consumables	O-ring for items to install in 11 mm ports (package of 10 pieces) (BBI-45100011) Clamping cone (Package of 5 pieces) (BBI-44130017)
Related Products	10 L cooling finger (BBI-43430305) Temperature sensor Pt100, 1 m (BBI-43430020) Temperature sensor Pt100, 3 m (BBI-43430023)

Description:

- For use with bioreactors
- Fitting to install PT100 probes
- Casing without probe



To the Shop:



Alle / Verkaufsartikel / Accessories / Temperature control / Pt100 casings

0.5 L Pt100 casing



bbi Scancode	BBI-43430007
Manufacturer	bbi-biotech GmbH
External Thread	M 10 x 1
Installation Depth	112 mm
Material Certificate	3.1, Rauigkeit, FDA
Country of Origin	DE 
HS-Code	73269098
Weight	0.04 kg
Material	Stainless steel 316L EPDM black PTFE

Components	1x empty tube, 1x o-ring [BBI-45100011], 1x coupling nut M 10 x 1 (flat) [BBI-44130009], 1x coupling nut M 10x1 (high) [BBI-44130010], 1x clamping cone [BBI-44130017]
Consumables	O-ring for items to install in 11 mm ports (package of 10 pieces) (BBI-45100011) Clamping cone (Package of 5 pieces) (BBI-44130017)
Related Products	0.5 L lid (BBI-44430002) Temperature sensor Pt100, 1 m (BBI-43430020) Temperature sensor Pt100, 3 m (BBI-43430023)

Description:

- For use with bioreactors
- Fitting to install PT100 probes
- Casing without probe



To the Shop:



Alle / Verkaufsartikel / Accessories / Temperature control / Pt100 casings

0.5 L Pt100 casing with baffle



bbi Scancode	BBI-43430011
Manufacturer	bbi-biotech GmbH
External Thread	M 10 x 1
Installation Depth	112 mm
Material Certificate	3.1, Rauigkeit, FDA
Country of Origin	DE 
HS-Code	73269098
Material	Stainless steel 316L EPDM black PTFE

Components	1x empty tube with baffle, 1x o-ring [BBI-45100011], 1x coupling nut M 10 x 1 (flat) [BBI-44130009], 1x coupling nut M 10x1 (high) [BBI-44130010], 1x clamping cone [BBI-44130017]
Related Products	0.5 L lid (BBI-44430002) Temperature sensor Pt100, 1 m (BBI-43430020) Temperature sensor Pt100, 3 m (BBI-43430023)

Description:

- For use with bioreactors
- Fitting to install PT100 probes
- Casing without probe
- For accurate temperature monitoring
- The inclusion of baffles ensures the temperature is evenly distributed, providing reliable readings that are vital for maintaining optimal growth conditions
- Baffles enable an enhanced mixing of cells, nutrients, and gases
- Improved mass transfer and oxygen distribution
- Optimized microbial culture productivity
- Disruption of liquid flow for efficient nutrient distribution
- Increased turbulence leading to better microbial growth



Alle / Verkaufsartikel / Accessories / Temperature control / Pt100 casings

1 L Pt100 casing with baffle



bbi Scancode	BBI-43430012
Manufacturer	bbi-biotech GmbH
External Thread	M 10 x 1
Installation Depth	152 mm
Material Certificate	3.1, Rauigkeit, FDA
Country of Origin	DE 
HS-Code	73269098
Material	Stainless steel 316L EPDM black PTFE

Components

1x empty tube with baffle, 1x o-ring [BBI-45100011], 1x coupling nut M 10 x 1 (flat) [BBI-44130009], 1x coupling nut M 10x1 (high) [BBI-44130010], 1x clamping cone [BBI-44130017]

Description:

- For use with bioreactors
- Fitting to install PT100 probes
- Casing without probe
- For accurate temperature monitoring
- The inclusion of baffles ensures the temperature is evenly distributed, providing reliable readings that are vital for maintaining optimal growth conditions
- Baffles enable an enhanced mixing of cells, nutrients, and gases
- Improved mass transfer and oxygen distribution
- Optimized microbial culture productivity
- Disruption of liquid flow for efficient nutrient distribution
- Increased turbulence leading to better microbial growth



To the Shop:



Alle / Verkaufsartikel / Accessories / Temperature control / Pt100 casings

2 L Pt100 casing with baffle



bbi Scancode	BBI-43430013
Manufacturer	bbi-biotech GmbH
External Thread	M 10 x 1
Installation Depth	217 mm
Material Certificate	3.1, Rauigkeit, FDA
Country of Origin	DE 
HS-Code	73269098
Material	Stainless steel 316L EPDM black PTFE

Components	1x empty tube with baffle, 1x o-ring [BBI-45100011], 1x coupling nut M 10 x 1 (flat) [BBI-44130009], 1x coupling nut M 10x1 (high) [BBI-44130010], 1x clamping cone [BBI-44130017]
Related Products	2 L Pt100 casing (BBI-43430004) Temperature sensor Pt100, 1 m (BBI-43430020) Temperature sensor Pt100, 3 m (BBI-43430023)

Description:

- For use with bioreactors
- Fitting to install PT100 probes
- Casing without probe
- For accurate temperature monitoring
- The inclusion of baffles ensures the temperature is evenly distributed, providing reliable readings that are vital for maintaining optimal growth conditions
- Baffles enable an enhanced mixing of cells, nutrients, and gases
- Improved mass transfer and oxygen distribution
- Optimized microbial culture productivity
- Disruption of liquid flow for efficient nutrient distribution
- Increased turbulence leading to better microbial growth



Alle / Verkaufsartikel / Accessories / Temperature control / Pt100 casings

5 L Pt100 casing with baffle



bbi Scancode	BBI-43430014
Manufacturer	bbi-biotech GmbH
External Thread	M 10 x 1
Installation Depth	317 mm
Material Certificate	3.1, Rauigkeit, FDA
Country of Origin	DE 
HS-Code	73269098
Material	Stainless steel 316L EPDM black PTFE

Components	1x empty tube with baffle, 1x o-ring [BBI-45100011], 1x coupling nut M 10 x 1 (flat) [BBI-44130009], 1x coupling nut M 10x1 (high) [BBI-44130010], 1x clamping cone [BBI-44130017]
Related Products	5 L Pt100 casing (BBI-43430005) Temperature sensor Pt100, 1 m (BBI-43430020) Temperature sensor Pt100, 3 m (BBI-43430023)

Description:

- For use with bioreactors
- Fitting to install PT100 probes
- Casing without probe
- For accurate temperature monitoring
- The inclusion of baffles ensures the temperature is evenly distributed, providing reliable readings that are vital for maintaining optimal growth conditions
- Baffles enable an enhanced mixing of cells, nutrients, and gases
- Improved mass transfer and oxygen distribution
- Optimized microbial culture productivity
- Disruption of liquid flow for efficient nutrient distribution
- Increased turbulence leading to better microbial growth



To the Shop:



Alle / Verkaufsartikel / Accessories / Temperature control / Pt100 casings

10 L Pt100 casing with baffle



bbi Scancode	BBI-43430015
Manufacturer	bbi-biotech GmbH
External Thread	M 10 x 1
Installation Depth	417 mm
Material Certificate	3.1, Rauigkeit, FDA
Country of Origin	DE 
HS-Code	73269098
Material	Stainless steel 316L EPDM black PTFE

Components	1x empty tube with baffle, 1x o-ring [BBI-45100011], 1x coupling nut M 10 x 1 (flat) [BBI-44130009], 1x coupling nut M 10x1 (high) [BBI-44130010], 1x clamping cone [BBI-44130017]
Related Products	10 L Pt100 casing (BBI-43430006) 10 L baffle, single (BBI-43530094) Temperature sensor Pt100, 3 m (BBI-43430023)

Description:

- For use with bioreactors
- Fitting to install PT100 probes
- Casing without probe
- For accurate temperature monitoring
- The inclusion of baffles ensures the temperature is evenly distributed, providing reliable readings that are vital for maintaining optimal growth conditions
- Baffles enable an enhanced mixing of cells, nutrients, and gases
- Improved mass transfer and oxygen distribution
- Optimized microbial culture productivity
- Disruption of liquid flow for efficient nutrient distribution
- Increased turbulence leading to better microbial growth



Alle / Verkaufsartikel / Accessories / Temperature control / Pt100 casings

1 L Pt100 casing



bbi Scancode	BBI-43430021
Manufacturer	bbi-biotech GmbH
External Thread	M 10 x 1
Installation Depth	152 mm
Material Certificate	3.1, Rauigkeit, FDA
Country of Origin	DE 
HS-Code	73269098
Weight	0.05 kg
Material	Stainless steel 316L EPDM black PTFE

Components	1x empty tube, 1x o-ring [BBI-45100011], 1x coupling nut M 10 x 1 (flat) [BBI-44130009], 1x coupling nut M 10x1 (high) [BBI-44130010], 1x clamping cone [BBI-44130017]
Consumables	O-ring for items to install in 11 mm ports (package of 10 pieces) (BBI-45100011) Clamping cone (Package of 5 pieces) (BBI-44130017)
Description: <ul style="list-style-type: none"> • For use with bioreactors • Fitting to install PT100 probes • Casing without probe 	



To the Shop:



Alle / Verkaufsartikel / Accessories / Temperature control / Pt100 casings

20 L Pt100 casing



bbi Scancode	BBI-43430022
Manufacturer	bbi-biotech GmbH
External Thread	M 10 x 1
Material Certificate	3.1, Rauigkeit, FDA
Country of Origin	DE 
HS-Code	73269098
Material	Stainless steel 316L EPDM black PTFE

Components	1x empty tube, 1x o-ring [BBI-45100011], 1x coupling nut M 10 x 1 (flat) [BBI-44130009], 1x coupling nut M 10x1 (high) [BBI-44130010], 1x clamping cone [BBI-44130017]
Related Products	20 L Rushton impeller (BBI-43230704) 20 L aeration basket (BBI-43530104) 20 L ring sparger, downwards-facing holes (BBI-43530093)
<p>Description:</p> <ul style="list-style-type: none"> • For use with bioreactors • Fitting to install PT100 probes • Casing without probe 	



Alle / Verkaufsartikel / Accessories / Temperature control / Pt100 sensors

Temperature sensor Pt100, 1 m



bbi Scancode	BBI-43430020
Manufacturer	bbi-biotech GmbH
Country of Origin	DE 
HS-Code	90251900
Weight	0.06 kg
Material	stainless steel silicone

Components	1x sensor incl. Lemo plug
Related Products	Pt100 Temperature sensor Ø 3 mm, 2 m (BBI-43430025) Pt100 temperatur sensor, 70 cm (BBI-43430024) Temperature sensor Pt100 suitable for Biostat C (BBI-43430601)
Description: <ul style="list-style-type: none"> • Temperature sensor 6 x 50 mm • For use with pt100 casing (available separately) • 1 m cable • Connection with Lemo 	



To the Shop:



Alle / Verkaufsartikel / Accessories / Temperature control / Pt100 sensors

Temperature sensor Pt100, 3 m



bbi Scancode	BBI-43430023
Manufacturer	bbi-biotech GmbH
Country of Origin	DE 
HS-Code	90251900
Weight	0.1 kg
Material	stainless steel silicone

Components	1x sensor incl. Lemo plug
Related Products	Pt100 Temperature sensor Ø 3 mm, 2 m (BBI-43430025) Pt100 temperatur sensor, 70 cm (BBI-43430024) Temperature sensor Pt100, 1 m (BBI-43430020)
Description: <ul style="list-style-type: none"> • Temperature sensor 6 x 50 mm • For use with pt100 casing (available separately) • 3 m cable • Connection with Lemo 	



To the Shop:



Alle / Verkaufsartikel / Accessories / Temperature control / Pt100 sensors

Pt100 temperatur sensor, 70 cm



bbi Scancode	BBI-43430024
Manufacturer	bbi-biotech GmbH
Country of Origin	CH
HS-Code	90251900
Weight	0.05 kg
Material	stainless steel silicone

Components	1x sensor incl. Lemo plug
Related Products	Pt100 Temperature sensor Ø 3 mm, 2 m (BBI-43430025) Temperature sensor Pt100, 1 m (BBI-43430020) Temperature sensor Pt100, 3 m (BBI-43430023)
Description: <ul style="list-style-type: none"> • Temperature sensor 6 x 50 mm • For use with pt100 casing (available separately) • 70 cm cable • Connection with Lemo 	



To the Shop:



Alle / Verkaufsartikel / Accessories / Temperature control / Pt100 sensors

Pt100 Temperature sensor Ø 3 mm, 2 m



bbi Scancode	BBI-43430025
Manufacturer	bbi-biotech GmbH
Country of Origin	DE 
HS-Code	90251900
Weight	0.06 kg
Material	stainless steel silicone

Components	1x sensor incl. Lemo plug
Related Products	Pt100 temperatur sensor, 70 cm (BBI-43430024) Temperature sensor Pt100, 1 m (BBI-43430020) Temperature sensor Pt100, 3 m (BBI-43430023)
Description: <ul style="list-style-type: none"> • Temperature sensor Ø 3 mm • For use with pt100 casing (available separately) • 2 m cable • Connection with Lemo 	



To the Shop:



Alle / Verkaufsartikel / Accessories / Temperature control / Pt100 sensors

Temperature sensor Pt100 suitable for Biostat C



bbi Scancode	BBI-43430601
Manufacturer	bbi-biotech GmbH
External Thread	M 16 x 1,5
Country of Origin	DE 
HS-Code	90251900

Components	1x temperature sensor
Related Products	Pt100 Temperature sensor Ø 3 mm, 2 m (BBI-43430025) Temperature sensor Pt100, 1 m (BBI-43430020) Temperature sensor Pt100, 3 m (BBI-43430023)
Description: <ul style="list-style-type: none"> • Screw-in resistance thermometer with connecting cable and fixed screw connection • Operating temperature: -50 to +130°C • With Lemo plug • Ø 6 mm 	



To the Shop:



Alle / Verkaufsartikel / Accessories / Temperature control / Temperature control units

Temperature module single



bbi Scancode	BBI-22000001
Manufacturer	bbi-biotech GmbH
Country of Origin	DE 
HS-Code	90321020
Weight	10.6 kg

Components	1x temperature module
Related Products	<p>Circulation pump for temperature module (BBI-43430501)</p> <p>Hose connection set exhaust cooler-tempering module (BBI-44430113)</p> <p>Hose connection set vessel-tempering module (BBI-44430112)</p>
<p>Description:</p> <p>For use with xCUBIO controller and jacketed glass vessel</p>	



Alle / Verkaufsartikel / Accessories / Temperature control / Temperature control units

Temperature module twin



bbi Scancode	BBI-22000002
Manufacturer	bbi-biotech GmbH
Country of Origin	DE 
HS-Code	90321020
Weight	13.6 kg

Components	1x temperature module
Related Products	<ul style="list-style-type: none"> Circulation pump for temperature module (BBI-43430501) Set of hose connections for single temperature module (BBI-44430115) Temperature module single (BBI-22000001)
<p>Description:</p> <p>For use with xCUBIO controller and jacketed glass vessel</p>	



Alle / Verkaufsartikel / Accessories / Temperature control / Temperature control units

Circulation pump for temperature module



bbi Scancode	BBI-43430501
Country of Origin	CN 

Components	1x pump
Related Products	Hose connection set vessel-tempering module (BBI-44430112) Set of hose connections for temperature control module twin (BBI-44430116) Temperature module single (BBI-22000001)
Description: Spare part for temperature module	



To the Shop:



Alle / Verkaufsartikel / Accessories / Temperature control / Temperature control units

Hose connection set vessel-tempering module



bbi Scancode	BBI-44430112
Manufacturer	bbi-biotech GmbH
Country of Origin	DE 
Weight	0,52 kg

Components	2x hose connection
Related Products	Hose connection set supply-tempering module (BBI-44430114) Hose connection set vessel GL 14 (BBI-44430110) Hose connection set vessel-tempering module mini (BBI-44430117)
Description: Tube with quick connect couplings and hose nozzles	



Alle / Verkaufsartikel / Accessories / Temperature control / Temperature control units

Hose connection set exhaust cooler-tempering module



bbi Scancode	BBI-44430113
Manufacturer	bbi-biotech GmbH
Country of Origin	DE 
HS-Code	40092200
Weight	0.23 kg

Components	2x hose connection
Related Products	Hose connection set vessel-tempering module (BBI-44430112) Set of hose connections for single temperature module (BBI-44430115) Set of hose connections for temperature control module twin (BBI-44430116)
Description: Tube with quick connect couplings and hose nozzles	



To the Shop:



Alle / Verkaufsartikel / Accessories / Temperature control / Temperature control units

Hose connection set supply-tempering module



bbi Scancode	BBI-44430114
Manufacturer	bbi-biotech GmbH
Country of Origin	DE 
Weight	0.5 kg

Components	2x hose connection
Related Products	<p>Hose connection set vessel GL 18 (BBI-44430111)</p> <p>Hose connection set vessel-tempering module (BBI-44430112)</p> <p>Set of hose connections for single temperature module (BBI-44430115)</p>
<p>Description:</p> <p>Tube with hose nozzles</p>	



Alle / Verkaufsartikel / Accessories / Temperature control / Temperature control units

Set of hose connections for single temperature module



bbi Scancode	BBI-44430115
Manufacturer	bbi-biotech GmbH
Country of Origin	DE 

Components	1x hose connection set supply-tempering module [BBI-44430114]; 1x hose connection set vessel-tempering module [BBI-44430112]; 1x hose connection set exhaust cooler-tempering module [BBI-44430113]
Related Products	Hose connection set exhaust cooler-tempering module (BBI-44430113) Set of hose connections for 2x temperature control module twin to chiller (BBI-44430118) Set of hose connections for temperature control module twin (BBI-44430116)
<p>Description:</p> <p>Tube with quick connect couplings and hose nozzles</p>	



Alle / Verkaufsartikel / Accessories / Temperature control / Temperature control units

Set of hose connections for temperature control module twin



bbi Scancode	BBI-44430116
Manufacturer	bbi-biotech GmbH
Country of Origin	DE 

Components	1x hose connection set supply-tempering module [BBI-44430114]; 2x hose connection set vessel-tempering module [BBI-44430112]; 2x hose connection set exhaust cooler-tempering module [BBI-44430113]
Related Products	Hose connection set supply-tempering module (BBI-44430114) Set of hose connections for 2x temperature control module twin to chiller (BBI-44430118) Set of hose connections for single temperature module (BBI-44430115)
<p>Description:</p> <p>Tube with quick connect couplings and hose nozzles</p>	



Alle / Verkaufsartikel / Accessories / Temperature control / Temperature control units

Hose connection set vessel-tempering module mini



bbi Scancode	BBI-44430117
Manufacturer	bbi-biotech GmbH
Country of Origin	DE 

Components	1x hose connection
Related Products	Hose connection set supply-tempering module (BBI-44430114) Hose connection set vessel GL 14 (BBI-44430110) Hose connection set vessel-tempering module (BBI-44430112)
Description: Tube with quick connect couplings and hose nozzles	



To the Shop:



Alle / Verkaufsartikel / Accessories / Uncategorized

Mini-safety valve, M 10 x 1



bbi Scancode	BBI-43930121
Manufacturer	bbi-biotech GmbH
External Thread	M 10 x 1
Material Certificate	3.1, Rauigkeit, FDA
Country of Origin	DE 
HS-Code	73269098
Material	Stainless steel 316L EPDM black

Components	1x safety valve; 1x universal adapter [BBI-43930002]
Related Products	Blind plug M 10 x 1 (BBI-44130207)
<p>Description:</p> <p>Installation in lid port 11 mm</p>	



Alle / Verkaufsartikel / Accessories / Uncategorized

Welding port Rd 28 x 1/8

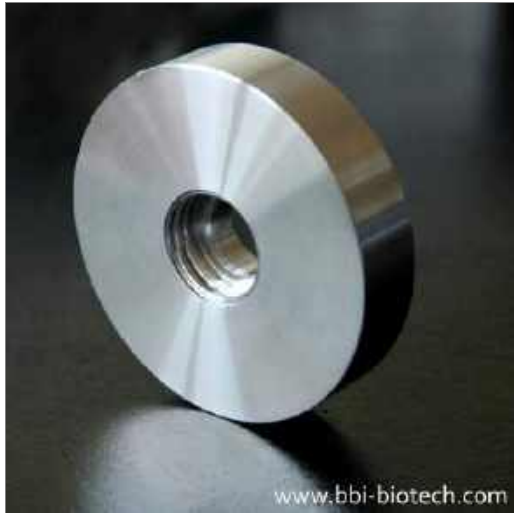

bbi Scancode	BBI-44130020
Manufacturer	bbi-biotech GmbH
Internal Thread	Rd 28 x 1/8
Material Certificate	3.1, Rauigkeit
Country of Origin	DE 
HS-Code	73269098
Weight	0.79 kg
Material	Stainless steel 316L

Components	1x welding port
Related Products	1-way addition port Ø 6 mm, Rd 28 x 1/8 (BBI-43630103) Blind plug Rd 28 x 1/8 (BBI-44130205) Membrane Holder Rd 28 x 1/8 (BBI-44130005)
<p>Description:</p> <ul style="list-style-type: none"> • Welding port with Rd 28 x 1/8"-thread • Counter part to our products with Rd 28x1/8"-outer thread • For 19.05 mm lid thickness 	



Alle / Verkaufsartikel / Accessories / Uncategorized

Pressure compensation vessel 2 L



bbi Scancode	BBI-44435052
Manufacturer	bbi-biotech GmbH
Material Certificate	3.1
Country of Origin	DE 
Weight	1.53 kg
Material	Stainless steel 316L

Components	1x pressure compensation vessel
Related Products	Pressure compensation vessel 5 L (BBI-44435053)
Description:	



To the Shop:



Alle / Verkaufsartikel / Accessories / Uncategorized

Pressure compensation vessel 5 L



bbi Scancode	BBI-44435053
Manufacturer	bbi-biotech GmbH
Material Certificate	3.1
Country of Origin	DE 
Material	Stainless steel 316L

Components	1x pressure compensation vessel
Related Products	Pressure compensation vessel 2 L (BBI-44435052)
Description:	



To the Shop:



Alle / Verkaufsartikel / Accessories / Uncategorized / Filter

Filter housing T-WIT complete mini 76.1 with small flow rate



bbi Scancode	BBI-43930506
Manufacturer	bbi-biotech GmbH
Country of Origin	DE 

Components

Related Products

Filter housing T-WIT complete mini 76.1 with large flow rate (BBI-43930507)

Description:



To the Shop:



Alle / Verkaufsartikel / Accessories / Uncategorized / Filter

Filter housing T-WIT complete mini 76.1 with large flow rate



bbi Scancode	BBI-43930507
Manufacturer	bbi-biotech GmbH
Country of Origin	DE 

Components	
Related Products	Filter housing T-WIT complete mini 76.1 with small flow rate (BBI-43930506)
Description:	



To the Shop:



Alle / Verkaufsartikel / Accessories / Uncategorized / Filter

Sterile filter 30 mm 0.2 µm (package of 10 pieces)



bbi Scancode	BBI-44130510
Country of Origin	CA 🇨🇦
HS-Code	84219990
Weight	0.04 kg
Material	PTFE

Components	10x filter
Related Products	Gassing tube for sparger (BBI-44130620) Reservoir bottle 250 ml with 2 hose nozzles 4 x 1 mm (BBI-44130500) Sterile filter gas 50 mm (BBI-44130511)

Description:

- Sterile filter inlet air / headspace/ outlet air
- Membrane 0.2 µm
- PTFE white 30 mm
- Package of 10 pieces
- Spare part for e.g. reservoir bottles
- Luer lock



Alle / Verkaufsartikel / Accessories / Uncategorized / Filter

Sterile filter gas 50 mm



bbi Scancode	BBI-44130511
Country of Origin	US 
HS-Code	84219990
Weight	0.03 kg
Material	PTFE PP

Components	1x sterile filter
Related Products	Gassing tube for sparger (BBI-44130620) Sartofluor Membranfiltercapsule 0,2 µm 0,05 m² (BBI-44130512) Sterile filter 30 mm 0.2 µm (package of 10 pieces) (BBI-44130510)
<p>Description:</p> <ul style="list-style-type: none"> • Sterile filter inlet air / headspace/ outlet air • Membrane 0.2 µm • PTFE 50 mm, housing PP • Connection with hose olive 	



Alle / Verkaufsartikel / Accessories / Uncategorized / Filter

Sartofluor Membranfiltercapsule 0,2 µm 0,05 m²



bbi Scancode	BBI-44130512
Country of Origin	DE 
HS-Code	84219990

Components	1x filter
Related Products	Mini-filter (BBI-44130514) Sterile filter 30 mm 0.2 µm (package of 10 pieces) (BBI-44130510) Sterile filter gas 50 mm (BBI-44130511)
Description: <ul style="list-style-type: none"> • Pore size: 0.2 µm • filter area: 0.05 m² • Connection with hose olive 	



To the Shop:



Alle / Verkaufsartikel / Accessories / Uncategorized / Filter

Junior-filter



bbi Scancode	BBI-44130513
Material	PTFE silicone PP

Components	1x filter
Related Products	Mini-filter (BBI-44130514) Sartofluor Membranfiltercapsule 0,2 µm 0,05 m ² (BBI-44130512) Sterile filter gas 50 mm (BBI-44130511)
Description: <ul style="list-style-type: none"> • As supply air filter in filter housings for aeration of reactors up to 30 L working volume and for all double mechanical seals • Emflon • PFR 0.2 µm; Filter area 0.04 m² 	



To the Shop:



Alle / Verkaufsartikel / Accessories / Uncategorized / Filter

Mini-filter



bbi Scancode	BBI-44130514
Country of Origin	GB 
Material	PTFE PP

Components	1x filter
Related Products	<p>Junior-filter (BBI-44130513)</p> <p>Sterile filter 30 mm 0.2 µm (package of 10 pieces) (BBI-44130510)</p> <p>Sterile filter gas 50 mm (BBI-44130511)</p>
<p>Description:</p> <ul style="list-style-type: none"> • For exhaust air filter housings • 5" mini • Can also be used as a supply air filter • Emflon, filter area 0.28 m² 	



Alle / Verkaufsartikel / Accessories / Uncategorized / Pressure gauges

Manometer -1/+3 bar, Rd 28 x 1/8, 63 mm display



bbi Scancode	BBI-44435071
Manufacturer	bbi-biotech GmbH
External Thread	Rd 28 x 1/8
Country of Origin	DE 
HS-Code	90262040

Components	1x manometer, 1x o-ring
Related Products	Blind plug Rd 28 x 1/8 (BBI-44130205) Manometer -1/+3 bar, Rd 28 x 1/8, 100 mm display (BBI-44435072) Welding port Rd 28 x 1/8 (BBI-44130020)
Description: <ul style="list-style-type: none"> • Pressure gauge • Outer scale for temperature range +25°C • Inner scale for temperature range +121°C 	



To the Shop:



Alle / Verkaufsartikel / Accessories / Uncategorized / Pressure gauges

Manometer -1/+3 bar, Rd 28 x 1/8, 100 mm display



bbi Scancode	BBI-44435072
Manufacturer	bbi-biotech GmbH
External Thread	Rd 28 x 1/8
HS-Code	90262040

Components	1x manometer, 1x o-ring
Related Products	Blind plug Rd 28 x 1/8 (BBI-44130205) Manometer -1/+3 bar, Rd 28 x 1/8, 63 mm display (BBI-44435071) Welding port Rd 28 x 1/8 (BBI-44130020)
Description: <ul style="list-style-type: none"> • Pressure gauge • Outer scale for temperature range +25°C • Inner scale for temperature range +121°C 	



To the Shop:



Alle / Verkaufsartikel / Accessories / Uncategorized / O-rings for accessories

O-ring 5.23 x 2.62



bbi Scancode	BBI-45100010
Manufacturer	bbi-biotech GmbH
Material Certificate	FDA
Country of Origin	IT 
HS-Code	40169300
Weight	0.01 kg
Material	EPDM black

Components	1x o-ring
Related Products	O-ring for items to install in 25 mm Ingold ports (package of 10 pieces) (BBI-45100014) Sampling Valve SPN25, manual (BBI-43830200) Sampling valve 37 mm (manual) (BBI-43830201)
<p>Description:</p> <ul style="list-style-type: none"> • Suitable for sampling valves • Spare part for bioreactors 	



Alle / Verkaufsartikel / Accessories / Uncategorized / O-rings for accessories

O-ring for items to install in 11 mm ports (package of 10 pieces)



bbi Scancode	BBI-45100011
Manufacturer	bbi-biotech GmbH
Material Certificate	FDA
Country of Origin	IT 
HS-Code	40169300
Weight	0.01 kg
Material	EPDM black

Components	10x o-ring
Related Products	Inoculation port with septum for 11 mm ports (BBI-43630200) O-ring for items to install in 25 mm Ingold ports (package of 10 pieces) (BBI-45100014) O-ring for items to install in M 26 x 1 ports (package of 10 pieces) (BBI-45100015)
Description: <ul style="list-style-type: none"> • Suitable for items with M 10 x 1 thread • Spare part for bioreactors 	



To the Shop:



Alle / Verkaufsartikel / Accessories / Uncategorized / O-rings for accessories

O-ring 12.37 x 2.62



bbi Scancode	BBI-45100012
Manufacturer	bbi-biotech GmbH
Material Certificate	FDA
Country of Origin	IT 
HS-Code	40169300
Weight	0.01 kg
Material	EPDM black

Components	1x o-ring
Related Products	O-ring for items to install in 25 mm Ingold ports (package of 10 pieces) (BBI-45100014) Probe adapter 25 mm for G 1 ¼ (Ingold socket) for 12 mm probes (BBI-44130106) Sterile addition unit AP19 (BBI-43630300)
<p>Description:</p> <ul style="list-style-type: none"> • Suitable for • Passend für probe adapter 25 mm for G 1 ¼ (Ingold socket) for 12 mm probes [BBI-44130106] and sterile addition unit AP19 [BBI-43630300] 	



Alle / Verkaufsartikel / Accessories / Uncategorized / O-rings for accessories

O-ring for items to install in Rd 28 x 1/8 ports (package of 10 pieces)



bbi Scancode	BBI-45100013
Manufacturer	bbi-biotech GmbH
Material Certificate	FDA
Country of Origin	IT 
HS-Code	40169300
Material	EPDM black

Components	10x o-ring
Related Products	Blind plug Rd 28 x 1/8 (BBI-44130205) O-ring for items to install in 11 mm ports (package of 10 pieces) (BBI-45100011) O-ring for items to install in M 26 x 1 ports (package of 10 pieces) (BBI-45100015)
<p>Description:</p> <ul style="list-style-type: none"> • Suitable for items with Rd 28 x 1/8 thread • Spare part for bioreactors 	



Alle / Verkaufsartikel / Accessories / Uncategorized / O-rings for accessories

O-ring for items to install in 25 mm Ingold ports (package of 10 pieces)



bbi Scancode	BBI-45100014
Manufacturer	bbi-biotech GmbH
Material Certificate	FDA
Country of Origin	IT 
HS-Code	40169300
Material	EPDM black

Components	10x o-ring
Related Products	Blind Plug 25 mm for G 1 ¼ (Ingold socket), length 40 mm (BBI-44130209) O-ring for items to install in M 26 x 1 ports (package of 10 pieces) (BBI-45100015) Probe adapter 25 mm for G 1 ¼ (Ingold socket) for 12 mm probes (BBI-44130106)
<p>Description:</p> <ul style="list-style-type: none"> • Suitable for items for 25 mm Ingold port • Spare part for bioreactors 	



Alle / Verkaufsartikel / Accessories / Uncategorized / O-rings for accessories

O-ring for items to install in M 26 x 1 ports (package of 10 pieces)



bbi Scancode	BBI-45100015
Manufacturer	bbi-biotech GmbH
Material Certificate	FDA
Country of Origin	IT 
HS-Code	40169300
Material	EPDM black

Components	10x o-ring
Related Products	Blind plug for 19 mm ports M 26 x 1 (BBI-44130201) O-ring for items to install in 11 mm ports (package of 10 pieces) (BBI-45100011) O-ring for items to install in Rd 28 x 1/8 ports (package of 10 pieces) (BBI-45100013)
Description: <ul style="list-style-type: none"> • Suitable for items with M 26 x 1 thread • Spare part for bioreactors 	



Alle / Verkaufsartikel / Accessories / Uncategorized / O-rings for accessories

O-ring for blind plug Pg 42



bbi Scancode	BBI-45100016
Manufacturer	bbi-biotech GmbH
Material Certificate	FDA
Country of Origin	EU 
HS-Code	40169300
Material	EPDM black

Components	1x o-ring
Related Products	<p>Blind plug Pg 42 (BBI-44130215)</p> <p>O-ring for items to install in 11 mm ports (package of 10 pieces) (BBI-45100011)</p> <p>O-ring for items to install in M 26 x 1 ports (package of 10 pieces) (BBI-45100015)</p>
<p>Description:</p> <ul style="list-style-type: none"> • Suitable for blind plug Pg 42 [BBI-44130215] • Spare part for bioreactors 	



Alle / Verkaufsartikel / Accessories / Uncategorized / O-rings for accessories

O-ring 14.00 x 1.78 mm (package of 5 pieces)



bbi Scancode	BBI-45100017
Manufacturer	bbi-biotech GmbH
Material Certificate	FDA
HS-Code	40169300
Material	EPDM black

Components	5x o-ring
Related Products	<p>3-way Sacova 4 mm for Rd 28 x 1/8 standard port (BBI-43630206)</p> <p>O-ring for items to install in M 26 x 1 ports (package of 10 pieces) (BBI-45100015)</p> <p>O-ring for items to install in Rd 28 x 1/8 ports (package of 10 pieces) (BBI-45100013)</p>
<p>Description:</p> <ul style="list-style-type: none"> • Suitable for 3-way Sacova 4 mm for Rd 28 x 1/8 standard port [BBI-43630206] • Spare part for bioreactors 	



Alle / Verkaufsartikel / Accessories / Uncategorized / O-rings for accessories

O-ring for stirrer shaft



bbi Scancode	BBI-45100018
Manufacturer	bbi-biotech GmbH
Material Certificate	FDA
HS-Code	40169300
Material	EPDM black

Components	1x o-ring
Related Products	2 L stirrer shaft, 10 mm (BBI-43230041) 5 L stirrer shaft, 10 mm (BBI-43230046) Replacement set of seals for stirrer shaft (0.5 - 10 L) (BBI-43930203)
Description: <ul style="list-style-type: none"> • Suitable for stirrer shaft 0.5-10 L • Spare part for bioreactors 	



Alle / Verkaufsartikel / Accessories / Uncategorized / O-rings for accessories

O-ring for adapter (package of 5 pieces)



bbi Scancode	BBI-45100025
Manufacturer	bbi-biotech GmbH
Material Certificate	FDA
Country of Origin	IT 
HS-Code	40169300
Weight	0.01 kg
Material	EPDM black

Components	5x o-ring
Related Products	<p>Adapter for 6 mm level probes or dip tubes for harvesting in 11 mm ports (BBI-44630103)</p> <p>Adapter for 6 mm level probes or dip tubes for harvesting in 11 mm ports (long) (BBI-44630104)</p> <p>Clamping cone (Package of 5 pieces) (BBI-44130017)</p>
<p>Description:</p> <ul style="list-style-type: none"> • Suitable for clamp adapter for 6 mm level probe or dip tubes for harvesting in 11 mm ports [BBI-44630103] • Spare part for bioreactors 	



Alle / Verkaufsartikel / Accessories / Uncategorized / O-rings for accessories

O-ring for inoculation port cap (package of 5 pieces)



bbi Scancode	BBI-45100026
Manufacturer	bbi-biotech GmbH
Material Certificate	FDA
Country of Origin	IT 
HS-Code	40169300
Material	EPDM black

Components	5x o-ring
Related Products	Inoculation port with septum for 11 mm ports (BBI-43630200) O-ring for adapter (package of 5 pieces) (BBI-45100025) O-ring for items to install in 11 mm ports (package of 10 pieces) (BBI-45100011)
<p>Description:</p> <ul style="list-style-type: none"> • Suitable for inoculation port with septum for M10 x 1 [BBI-43630200] • Spare part for bioreactors 	



Alle / Verkaufsartikel / Accessories / Uncategorized / O-rings for accessories

O-Ring 3x1 (package of 10 pieces)



bbi Scancode	BBI-45100029
Manufacturer	bbi-biotech GmbH
Material Certificate	FDA
Material	EPDM black

Components	10x o-ring
Related Products	Antifoam or level probe L=100 mm (BBI-44630003) Antifoam or level probe L=150 mm (BBI-44630004) Antifoam or level probe L=80 mm (BBI-44630002)
Description: <ul style="list-style-type: none"> • Suitable for e.g. antifoam or level probes • Spare part for bioreactors 	



To the Shop:



Alle / Verkaufsartikel / Accessories / Uncategorized / O-rings for accessories

O-Ring 11.0x1.0 (package of 10 pieces)



bbi Scancode	BBI-45100030
Manufacturer	bbi-biotech GmbH
Material Certificate	FDA
Country of Origin	VN
Material	EPDM black

Components	10x o-ring
Related Products	<p>3-way addition port Ø 8 mm, M 26 x 1 (BBI-43630110)</p> <p>3-way addition port Ø 8 mm, Rd 28 x 1/8 (BBI-43630105)</p> <p>O-ring for items to install in 11 mm ports (package of 10 pieces) (BBI-45100011)</p>
<p>Description:</p> <ul style="list-style-type: none"> • Suitable for e.g. 3-way addition port Ø 8 mm, Rd 28 x 1/8 [BBI-43630105] and 3-way addition port Ø 8 mm, M 26 x 1 [BBI-43630110] • Spare part for bioreactors 	



Alle / Verkaufsartikel / Accessories / Uncategorized / O-rings for accessories

O-ring 1.5 x 0.75 EPDM (package: 10 pieces)



bbi Scancode	BBI-45100031
Manufacturer	bbi-biotech GmbH
Material Certificate	FDA
Material	EPDM black

Components	10x o-ring
Related Products	<p>O-ring for items to install in 11 mm ports (package of 10 pieces) (BBI-45100011)</p> <p>O-ring for items to install in 25 mm Ingold ports (package of 10 pieces) (BBI-45100014)</p> <p>O-ring for items to install in M 26 x 1 ports (package of 10 pieces) (BBI-45100015)</p>
Description:	



To the Shop:



Alle / Verkaufsartikel / Accessories / Uncategorized / Sight glasses

Sight glass with thread for 19 mm port Rd 28 x 1/8 and lamp



bbi Scancode	BBI-44130015
Manufacturer	bbi-biotech GmbH
External Thread	Rd 28 x 1/8
Material Certificate	3.1, Rauigkeit, FDA
Country of Origin	DE 
HS-Code	0
Material	Stainless steel 316L EPDM black

Components	1x sight glass, 1x o-ring, 1x flashlight
Related Products	Blind plug Rd 28 x 1/8 (BBI-44130205) O-ring for items to install in Rd 28 x 1/8 ports (package of 10 pieces) (BBI-45100013) Sight glass with thread for 19 mm port Rd 28 x 1/8 (BBI-44130016)
<p>Description:</p> <ul style="list-style-type: none"> • For visual inspection of the fermenter content • With thread for Rd 28 x 1/8 standard ports • Sight glass: 14 mm 	



Alle / Verkaufsartikel / Accessories / Uncategorized / Sight glasses

Sight glass with thread for 19 mm port Rd 28 × 1/8



bbi Scancode	BBI-44130016
Manufacturer	bbi-biotech GmbH
External Thread	Rd 28 × 1/8
Material Certificate	3.1, Rauigkeit, FDA
Country of Origin	DE 
HS-Code	0
Material	Stainless steel 316L EPDM black

Components	1x sight glass, 1x o-ring
Related Products	Blind plug Rd 28 × 1/8 (BBI-44130205) O-ring for items to install in Rd 28 × 1/8 ports (package of 10 pieces) (BBI-45100013) Sight glass with thread for 19 mm port Rd 28 × 1/8 and lamp (BBI-44130015)
<p>Description:</p> <ul style="list-style-type: none"> • For visual inspection of the fermenter content • With thread for Rd 28 × 1/8 standard ports • Sight glass: 14 mm 	



Alle / Verkaufsartikel / Accessories / Uncategorized / Tubes

Hose clamp stainless steel (package of 10 pieces)



bbi Scancode	BBI-43830104
Country of Origin	DE 
HS-Code	73269098
Weight	0.03 kg

Components	10x hose clamp
Related Products	Manual sampler (classical) (BBI-43830002) Silicone tube 3.2 x 1.6 mm (package with 10 m) (BBI-44130602) Silicone tube 8.0 x 1.5 mm (package with 10 m) (BBI-44130611)
Description: <ul style="list-style-type: none"> • Type Hoffmann • Width 30 mm 	



To the Shop:



Alle / Verkaufsartikel / Accessories / Uncategorized / Tubes

Silicone tube 1.6 x 0.8 mm (package with 10 m)



bbi Scancode	BBI-44130600
Material Certificate	FDA
Country of Origin	GB 
HS-Code	39173200
Weight	0.07 kg
Material	silicone transparent

Components	10 m silicone tube
Related Products	<p>Silicone tube 1.6 x 0.8 mm (package with 5 m) (BBI-44130603)</p> <p>Silicone tube 1.6 x 1.6 mm (package with 10 m) (BBI-44130601)</p> <p>Silicone tube 3.2 x 1.6 mm (package with 10 m) (BBI-44130602)</p>
<p>Description:</p> <ul style="list-style-type: none"> • Silicone tube for various applications • Package: 10 m • Quality: platinum • 60° Shore A, translucent • Inner diameter x wall thickness: 1.6 x 0.8 mm • Also available: packages of 5 m or 25 m 	



Alle / Verkaufsartikel / Accessories / Uncategorized / Tubes

Silicone tube 1.6 x 1.6 mm (package with 10 m)



bbi Scancode	BBI-44130601
Material Certificate	FDA
Country of Origin	GB 
HS-Code	39173200
Weight	0.19 kg
Material	silicone transparent

Components	10 m silicone tube
Related Products	<p>Silicone tube 1.6 x 0.8 mm (package with 10 m) (BBI-44130600)</p> <p>Silicone tube 1.6 x 1.6 mm (package with 25 m) (BBI-44130607)</p> <p>Silicone tube 3.2 x 1.6 mm (package with 10 m) (BBI-44130602)</p>

Description:

- Silicone tube for various applications
- Package: 10 m
- Quality: platinum
- 60° Shore A, translucent
- Inner diameter x wall thickness: 1.6 x 1.6 mm
- Also available: packages of 5 m or 25 m



Alle / Verkaufsartikel / Accessories / Uncategorized / Tubes

Silicone tube 3.2 x 1.6 mm (package with 10 m)



bbi Scancode	BBI-44130602
Material Certificate	FDA
Country of Origin	GB 
HS-Code	39173200
Weight	0.29 kg
Material	silicone transparent

Components	10 m silicone tube
Related Products	<p>Silicone tube 1.6 x 0.8 mm (package with 10 m) (BBI-44130600)</p> <p>Silicone tube 1.6 x 1.6 mm (package with 10 m) (BBI-44130601)</p> <p>Silicone tube 3.2 x 1.6 mm (package with 25 m) (BBI-44130608)</p>

Description:

- Silicone tube for various applications
- Package: 10 m
- Quality: platinum
- 60° Shore A, translucent
- Inner diameter x wall thickness: 3.2 x 1.6 mm
- Also available: packages of 5 m or 25 m



Alle / Verkaufsartikel / Accessories / Uncategorized / Tubes

Silicone tube 1.6 x 0.8 mm (package with 5 m)



bbi Scancode	BBI-44130603
Material Certificate	FDA
Country of Origin	GB 
HS-Code	39173200
Weight	0.06 kg
Material	silicone transparent

Components	5 m silicone tube
Related Products	<p>Silicone tube 1.6 x 0.8 mm (package with 25 m) (BBI-44130606)</p> <p>Silicone tube 1.6 x 1.6 mm (package with 5 m) (BBI-44130604)</p> <p>Silicone tube 3.2 x 1.6 mm (package with 5 m) (BBI-44130605)</p>
Description: <ul style="list-style-type: none"> • Silicone tube for various applications • Package: 5 m • Quality: platinum • 60° Shore A, translucent • Inner diameter x wall thickness: 1.6 x 0.8 mm • Also available: packages of 10 m or 25 m 	



To the Shop:



Alle / Verkaufsartikel / Accessories / Uncategorized / Tubes

Silicone tube 1.6 x 1.6 mm (package with 5 m)



bbi Scancode	BBI-44130604
Material Certificate	FDA
Country of Origin	GB 
HS-Code	39173200
Weight	0.1 kg
Material	silicone transparent

Components	5 m silicone tube
Related Products	Silicone tube 1.6 x 0.8 mm (package with 5 m) (BBI-44130603) Silicone tube 1.6 x 1.6 mm (package with 25 m) (BBI-44130607) Silicone tube 3.2 x 1.6 mm (package with 5 m) (BBI-44130605)
Description: <ul style="list-style-type: none"> • Silicone tube for various applications • Package: 5 m • Quality: platinum • 60° Shore A, translucent • Inner diameter x wall thickness: 1.6 x 1.6 mm • Also available: packages of 10 m or 25 m 	



To the Shop:



Alle / Verkaufsartikel / Accessories / Uncategorized / Tubes

Silicone tube 3.2 x 1.6 mm (package with 5 m)



bbi Scancode	BBI-44130605
Material Certificate	FDA
Country of Origin	GB 
HS-Code	39173200
Weight	0.18 kg
Material	silicone transparent

Components	5 m silicone tube
Related Products	Silicone tube 1.6 x 0.8 mm (package with 5 m) (BBI-44130603) Silicone tube 1.6 x 1.6 mm (package with 10 m) (BBI-44130601) Silicone tube 3.2 x 1.6 mm (package with 25 m) (BBI-44130608)
Description: <ul style="list-style-type: none"> • Silicone tube for various applications • Package: 5 m • Quality: platinum • 60° Shore A, translucent • Inner diameter x wall thickness: 3.2 x 1.6 mm • Also available: packages of 10 m or 25 m 	



To the Shop:



Alle / Verkaufsartikel / Accessories / Uncategorized / Tubes

Silicone tube 1.6 x 0.8 mm (package with 25 m)



bbi Scancode	BBI-44130606
Material Certificate	FDA
Country of Origin	GB 
HS-Code	39173200
Weight	0.18 kg
Material	silicone transparent

Components	25 m silicone tube
Related Products	<p>Silicone tube 1.6 x 0.8 mm (package with 10 m) (BBI-44130600)</p> <p>Silicone tube 1.6 x 1.6 mm (package with 10 m) (BBI-44130601)</p> <p>Silicone tube 3.2 x 1.6 mm (package with 25 m) (BBI-44130608)</p>
<p>Description:</p> <ul style="list-style-type: none"> • Silicone tube for various applications • Package: 25 m • Quality: platinum • 60° Shore A, translucent • Inner diameter x wall thickness: 1.6 x 0.8 mm • Also available: packages of 5 m or 10 m 	



Alle / Verkaufsartikel / Accessories / Uncategorized / Tubes

Silicone tube 1.6 x 1.6 mm (package with 25 m)



bbi Scancode	BBI-44130607
Material Certificate	FDA
Country of Origin	GB 
HS-Code	39173200
Weight	0.45 kg
Material	silicone transparent

Components	25 m silicone tube
Related Products	<p>Silicone tube 1.6 x 0.8 mm (package with 25 m) (BBI-44130606)</p> <p>Silicone tube 1.6 x 1.6 mm (package with 5 m) (BBI-44130604)</p> <p>Silicone tube 3.2 x 1.6 mm (package with 25 m) (BBI-44130608)</p>
<p>Description:</p> <ul style="list-style-type: none"> • Silicone tube for various applications • Package: 25 m • Quality: platinum • 60° Shore A, translucent • Inner diameter x wall thickness: 1.6 x 1.6 mm • Also available: packages of 5 m or 10 m 	



Alle / Verkaufsartikel / Accessories / Uncategorized / Tubes

Silicone tube 3.2 x 1.6 mm (package with 25 m)



bbi Scancode	BBI-44130608
Material Certificate	FDA
Country of Origin	GB 
HS-Code	39173200
Material	silicone transparent

Components	25 m silicone tube
Related Products	<p>Silicone tube 1.6 x 0.8 mm (package with 25 m) (BBI-44130606)</p> <p>Silicone tube 1.6 x 1.6 mm (package with 25 m) (BBI-44130607)</p> <p>Silicone tube 3.2 x 1.6 mm (package with 5 m) (BBI-44130605)</p>
<p>Description:</p> <ul style="list-style-type: none"> • Silicone tube for various applications • Package: 25 m • Quality: platinum • 60° Shore A, translucent • Inner diameter x wall thickness: 3.2 x 1.6 mm • Also available: packages of 5 m or 10 m 	



Alle / Verkaufsartikel / Accessories / Uncategorized / Tubes

Silicone tube 12.7 x 3.5 mm (package with 1 m)



bbi Scancode	BBI-44130609
Material Certificate	FDA
HS-Code	39173200
Material	TPE

Components	1 m silicone tube
Related Products	Silicone tube 1.6 x 0.8 mm (package with 5 m) (BBI-44130603) Silicone tube 1.6 x 1.6 mm (package with 10 m) (BBI-44130601) Silicone tube 3.2 x 1.6 mm (package with 5 m) (BBI-44130605)
Description: <ul style="list-style-type: none"> • Inner diameter x wall thickness: 12.7 x 3.2 mm • Special thermoplastic elastomer (TPE) • Conformity: FDA • Particularly suitable for use in peristaltic pumps 	



To the Shop:



Alle / Verkaufsartikel / Accessories / Uncategorized / Tubes

Santoprene (TM) tube 1.6 x 0.8 mm (package with 25 m)



bbi Scancode	BBI-44130610
Material Certificate	FDA
HS-Code	39173200
Material	TPE

Components	25 m Santoprene tube
Related Products	<p>Silicone tube 1.6 x 0.8 mm (package with 10 m) (BBI-44130600)</p> <p>Silicone tube 1.6 x 0.8 mm (package with 25 m) (BBI-44130606)</p> <p>Silicone tube 1.6 x 0.8 mm (package with 5 m) (BBI-44130603)</p>
<p>Description:</p> <ul style="list-style-type: none"> • Inner diameter x wall thickness: 1.6 x 0.8 mm • TPE, beige • Conformity: FDA • To be used with sampling system bioPROBE • Particularly suitable for peristaltic pumps: peristaltic pumps in the laboratory and in the pharmaceutical industry, medicine, chemistry, biology, filling technology, in the cosmetics, food and beverage industry, in machine and device construction 	



Alle / Verkaufsartikel / Accessories / Uncategorized / Tubes

Silicone tube 8.0 x 1.5 mm (package with 10 m)



bbi Scancode	BBI-44130611
Material Certificate	FDA
HS-Code	39173200
Material	silicone transparent

Components	10 m silicone tube
Related Products	<p>Silicone tube 1.6 x 0.8 mm (package with 10 m) (BBI-44130600)</p> <p>Silicone tube 1.6 x 1.6 mm (package with 10 m) (BBI-44130601)</p> <p>Silicone tube 3.2 x 1.6 mm (package with 10 m) (BBI-44130602)</p>
<p>Description:</p> <ul style="list-style-type: none"> • Silicone tube for multiple applications, e.g. reservoir bottles, respectively headpieces or addition ports • Package: 10 m • Quality: platinum • 60° Shore A, translucent • Tolerance DIN 7715 • Inner diameter x wall thickness: 8.0 x 1.5 mm 	



Alle / Verkaufsartikel / Accessories / Uncategorized / Tubes

Silicone tube 2.0 x 1.0 mm (package with 5 m)



bbi Scancode	BBI-44130612
Material Certificate	FDA
Country of Origin	FR 
HS-Code	39173200
Weight	0.07 kg
Material	silicone transparent

Components	5 m silicone tube
Related Products	<p>Silicone tube 1.6 x 0.8 mm (package with 5 m) (BBI-44130603)</p> <p>Silicone tube 3.2 x 1.6 mm (package with 5 m) (BBI-44130605)</p> <p>Silicone tube 8.0 x 1.5 mm (package with 10 m) (BBI-44130611)</p>
<p>Description:</p> <ul style="list-style-type: none"> • Silicone tube for multiple applications, e.g. reservoir bottles, respectively headpieces or addition ports • Package: 5 m • Quality: platinum • 60° Shore A, translucent • Inner diameter x wall thickness: 2.0 x 1.0 mm 	



Alle / Verkaufsartikel / Accessories / Uncategorized / Tubes

Innovaprene tube (ID x WT: 0.5 mm x 1.0 mm) (package of 5 m)



bbi Scancode	BBI-44130613
Material Certificate	FDA
Country of Origin	CN 
HS-Code	40091100
Weight	0.03 kg
Material	Innovaprene

Components	5 m Innovaprene tube
Related Products	<p>Innovaprene tube (ID x WT: 0.5 mm x 1.0 mm) (package of 15 m) (BBI-44130614)</p> <p>Innovaprene tube (ID x WT: 1.0 mm x 1.0 mm) (package of 15 m) (BBI-44130615)</p> <p>Innovaprene tube (ID x WT: 2.0 mm x 1.0 mm) (package of 15 m) (BBI-44130616)</p>
<p>Description:</p> <ul style="list-style-type: none"> • For pumps by boxer, series gQX, gQQ and gK • Inner diameter x wall thickness: 0.5 x 1.0 mm 	



Alle / Verkaufsartikel / Accessories / Uncategorized / Tubes

Innovaprene tube (ID x WT: 0.5 mm x 1.0 mm) (package of 15 m)



bbi Scancode	BBI-44130614
Material Certificate	FDA
Country of Origin	CN 
HS-Code	40091100
Material	Innovaprene

Components	15 m Innovaprene tube
Related Products	<p>Innovaprene tube (ID x WT: 0.5 mm x 1.0 mm) (package of 5 m) (BBI-44130613)</p> <p>Innovaprene tube (ID x WT: 1.0 mm x 1.0 mm) (package of 15 m) (BBI-44130615)</p> <p>Innovaprene tube (ID x WT: 2.0 mm x 1.0 mm) (package of 15 m) (BBI-44130616)</p>
<p>Description:</p> <ul style="list-style-type: none"> • For pumps by boxer, series gQX, gQQ and gK • Inner diameter x wall thickness: 0.5 x 1.0 mm 	



Alle / Verkaufsartikel / Accessories / Uncategorized / Tubes

Innovaprene tube (ID x WT: 1.0 mm x 1.0 mm) (package of 15 m)



bbi Scancode	BBI-44130615
Material Certificate	FDA
Country of Origin	CN ●
HS-Code	40091100
Material	Innovaprene

Components	15 m Innovaprene tube
Related Products	<p>Innovaprene tube (ID x WT: 0.5 mm x 1.0 mm) (package of 15 m) (BBI-44130614)</p> <p>Innovaprene tube (ID x WT: 0.5 mm x 1.0 mm) (package of 5 m) (BBI-44130613)</p> <p>Innovaprene tube (ID x WT: 2.0 mm x 1.0 mm) (package of 15 m) (BBI-44130616)</p>
<p>Description:</p> <ul style="list-style-type: none"> • For pumps by boxer, series gQX, gQQ and gK • Inner diameter x wall thickness: 1.0 x 1.0 mm 	



Alle / Verkaufsartikel / Accessories / Uncategorized / Tubes

Innovaprene tube (ID x WT: 2.0 mm x 1.0 mm) (package of 15 m)



bbi Scancode	BBI-44130616
Material Certificate	FDA
Country of Origin	CN ●
HS-Code	40091100
Material	Innovaprene

Components	15 m Innovaprene tube
Related Products	Innovaprene tube (ID x WT: 0.5 mm x 1.0 mm) (package of 15 m) (BBI-44130614) Innovaprene tube (ID x WT: 1.0 mm x 1.0 mm) (package of 15 m) (BBI-44130615) Innovaprene tube (ID x WT: 3.0 mm x 1.0 mm) (package of 15 m) (BBI-44130617)
Description: <ul style="list-style-type: none"> • For pumps by boxer, series gQX, gQQ and gK • Inner diameter x wall thickness: 2.0 x 1.0 mm 	



To the Shop:



Alle / Verkaufsartikel / Accessories / Uncategorized / Tubes

Innovaprene tube (ID x WT: 3.0 mm x 1.0 mm) (package of 15 m)



bbi Scancode	BBI-44130617
Material Certificate	FDA
Country of Origin	CN ●
HS-Code	40091100
Material	Innovaprene

Components	15 m Innovaprene tube
Related Products	<p>Innovaprene tube (ID x WT: 0.5 mm x 1.0 mm) (package of 15 m) (BBI-44130614)</p> <p>Innovaprene tube (ID x WT: 1.0 mm x 1.0 mm) (package of 15 m) (BBI-44130615)</p> <p>Innovaprene tube (ID x WT: 2.0 mm x 1.0 mm) (package of 15 m) (BBI-44130616)</p>
<p>Description:</p> <ul style="list-style-type: none"> • For pumps by boxer, series gQX, gQQ and gK • Inner diameter x wall thickness: 3.0 x 1.0 mm 	



Alle / Verkaufsartikel / Accessories / Uncategorized / Tubes

Innovaprene tube (ID x WT: 3.5 mm x 1.0 mm) (package of 15 m)



bbi Scancode	BBI-44130618
Material Certificate	FDA
Country of Origin	CN ●
HS-Code	40091100
Material	Innovaprene

Components	15 m Innovaprene tube
Related Products	Innovaprene tube (ID x WT: 0.5 mm x 1.0 mm) (package of 15 m) (BBI-44130614) Innovaprene tube (ID x WT: 2.0 mm x 1.0 mm) (package of 15 m) (BBI-44130616) Innovaprene tube (ID x WT: 3.0 mm x 1.0 mm) (package of 15 m) (BBI-44130617)
Description: <ul style="list-style-type: none"> • For pumps by boxer, series gQX, gQQ and gK • Inner diameter x wall thickness: 3.5 x 1.0 mm 	



To the Shop:



Alle / Verkaufsartikel / Accessories / Uncategorized / Tubes

Gassing tube for sparger



bbi Scancode	BBI-44130620
Manufacturer	bbi-biotech GmbH
Country of Origin	DE 
HS-Code	39173200
Weight	0.03 kg
Material	silicone transparent PVDF polyurethan

Components	1x gassing tube
Consumables	Silicone tube 3.2 x 1.6 mm (package with 5 m) (BBI-44130605) Luer-lock-adapter female for 4 mm tubing (package of 20 pieces) (BBI-45110206) Luer-lock-adapter male for 3.2 mm tubing (package of 20 pieces) (BBI-45110203)
Related Products	0.5 L ring sparger, upwards-facing holes with 0.8 mm (BBI-43530250) 5 L Microsparger without frit (BBI-43530203) Sterile filter gas 50 mm (BBI-44130511)
Description: <ul style="list-style-type: none"> To connect microsparger or ringsparger with controller 	



Alle / Verkaufsartikel / Accessories / Uncategorized / Tubes

Pharm-a-line (ID x WT: 0.5 mm x 1.0 mm) (package of 15 m)



bbi Scancode	BBI-44130630
Material Certificate	FDA
Country of Origin	CN ●
HS-Code	40091100
Material	TPE

Components	15 m tube
Related Products	Pharm-a-line (ID x WT: 1.0 mm x 1.0 mm) (package of 15 m) (BBI-44130631) Pharm-a-line (ID x WT: 3.0 mm x 1.0 mm) (package of 15 m) (BBI-44130633) Pharm-a-line (ID x WT: 3.5 mm x 1.0 mm) (package of 15 m) (BBI-44130634)
Description: <ul style="list-style-type: none"> • For pumps by boxer, series 9QX, 9QQ and gK • Inner diameter x wall thickness: 0.5 x 1.0 mm 	



To the Shop:



Alle / Verkaufsartikel / Accessories / Uncategorized / Tubes

Pharm-a-line (ID x WT: 1.0 mm x 1.0 mm) (package of 15 m)



bbi Scancode	BBI-44130631
Material Certificate	FDA
Country of Origin	CN ●
HS-Code	40091100
Material	TPE

Components	15 m tube
Related Products	Pharm-a-line (ID x WT: 0.5 mm x 1.0 mm) (package of 15 m) (BBI-44130630) Pharm-a-line (ID x WT: 2.0 mm x 1.0 mm) (package of 15 m) (BBI-44130632) Pharm-a-line (ID x WT: 3.0 mm x 1.0 mm) (package of 15 m) (BBI-44130633)
Description: <ul style="list-style-type: none"> • For pumps by boxer, series gQX, gQQ and gK • Inner diameter x wall thickness: 1.0 x 1.0 mm 	



To the Shop:



Alle / Verkaufsartikel / Accessories / Uncategorized / Tubes

Pharm-a-line (ID x WT: 2.0 mm x 1.0 mm) (package of 15 m)



bbi Scancode	BBI-44130632
Material Certificate	FDA
Country of Origin	CN ●
HS-Code	40091100
Material	TPE

Components	15 m tube
Related Products	<p>Pharm-a-line (ID x WT: 0.5 mm x 1.0 mm) (package of 15 m) (BBI-44130630)</p> <p>Pharm-a-line (ID x WT: 1.0 mm x 1.0 mm) (package of 15 m) (BBI-44130631)</p> <p>Pharm-a-line (ID x WT: 3.0 mm x 1.0 mm) (package of 15 m) (BBI-44130633)</p>
<p>Description:</p> <ul style="list-style-type: none"> • For pumps by boxer, series gQX, gQQ and gK • Inner diameter x wall thickness: 2.0 x 1.0 mm 	



Alle / Verkaufsartikel / Accessories / Uncategorized / Tubes

Pharm-a-line (ID x WT: 3.0 mm x 1.0 mm) (package of 15 m)



bbi Scancode	BBI-44130633
Material Certificate	FDA
Country of Origin	CN 
HS-Code	40091100
Material	TPE

Components	15 m tube
Related Products	Pharm-a-line (ID x WT: 0.5 mm x 1.0 mm) (package of 15 m) (BBI-44130630) Pharm-a-line (ID x WT: 1.0 mm x 1.0 mm) (package of 15 m) (BBI-44130631) Pharm-a-line (ID x WT: 2.0 mm x 1.0 mm) (package of 15 m) (BBI-44130632)
Description: <ul style="list-style-type: none"> • For pumps by boxer, series gQX, gQQ and gK • Inner diameter x wall thickness: 3.0 x 1.0 mm 	



To the Shop:



Alle / Verkaufsartikel / Accessories / Uncategorized / Tubes

Pharm-a-line (ID x WT: 3.5 mm x 1.0 mm) (package of 15 m)



bbi Scancode	BBI-44130634
Material Certificate	FDA
Country of Origin	CN ●
HS-Code	40091100
Material	TPE

Components	15 m tube
Related Products	<p>Pharm-a-line (ID x WT: 0.5 mm x 1.0 mm) (package of 15 m) (BBI-44130630)</p> <p>Pharm-a-line (ID x WT: 1.0 mm x 1.0 mm) (package of 15 m) (BBI-44130631)</p> <p>Pharm-a-line (ID x WT: 2.0 mm x 1.0 mm) (package of 15 m) (BBI-44130632)</p>
<p>Description:</p> <ul style="list-style-type: none"> • For pumps by boxer, series gQX, gQQ and gK • Inner diameter x wall thickness: 3.5 x 1.0 mm 	



Alle / Verkaufsartikel / Accessories / Uncategorized / Tubes

Luer-lock-adapter male for 2.4 mm tubing (package of 20 pieces)



bbi Scancode	BBI-45110201
Country of Origin	US 🇺🇸
HS-Code	3917400090
Material	PVDF

Components	20x luer lock adapter
Related Products	Luer-lock-adapter female for 2.4 mm tubing (package of 20 pieces) (BBI-45110202) Luer-lock-adapter male for 3.2 mm tubing (package of 20 pieces) (BBI-45110203) Luer-lock-adapter male for 4 mm tubing (package of 20 pieces) (BBI-45110205)
Description: <ul style="list-style-type: none"> • Hose connector • Autoclavable 	



To the Shop:



Alle / Verkaufsartikel / Accessories / Uncategorized / Tubes

Luer-lock-adapter female for 2.4 mm tubing (package of 20 pieces)



bbi Scancode	BBI-45110202
Country of Origin	US 🇺🇸
HS-Code	3917400090
Weight	0.01 kg
Material	PVDF

Components	20x luer lock adapter
Related Products	Luer-lock-adapter female for 3.2 mm tubing (package of 20 pieces) (BBI-45110204) Luer-lock-adapter male for 2.4 mm tubing (package of 20 pieces) (BBI-45110201) Luer-lock-adapter male for 3.2 mm tubing (package of 20 pieces) (BBI-45110203)
Description: <ul style="list-style-type: none"> • Hose connector • Autoclavable 	



To the Shop:



Alle / Verkaufsartikel / Accessories / Uncategorized / Tubes

Luer-lock-adapter male for 3.2 mm tubing (package of 20 pieces)



bbi Scancode	BBI-45110203
Country of Origin	US 🇺🇸
HS-Code	3917400090
Weight	0.02 kg
Material	PVDF

Components	20x luer lock adapter
Related Products	Luer-lock-adapter female for 3.2 mm tubing (package of 20 pieces) (BBI-45110204) Luer-lock-adapter male for 2.4 mm tubing (package of 20 pieces) (BBI-45110201) Luer-lock-adapter male for 4 mm tubing (package of 20 pieces) (BBI-45110205)
Description: <ul style="list-style-type: none"> • Hose connector • Autoclavable 	



To the Shop:



Alle / Verkaufsartikel / Accessories / Uncategorized / Tubes

Luer-lock-adapter female for 3.2 mm tubing (package of 20 pieces)



bbi Scancode	BBI-45110204
Country of Origin	US 🇺🇸
HS-Code	3917400090
Weight	0.01 kg
Material	PVDF

Components	20x luer lock adapter
Related Products	<p>Luer-lock-adapter female for 2.4 mm tubing (package of 20 pieces) (BBI-45110202)</p> <p>Luer-lock-adapter male for 2.4 mm tubing (package of 20 pieces) (BBI-45110201)</p> <p>Luer-lock-adapter male for 3.2 mm tubing (package of 20 pieces) (BBI-45110203)</p>
<p>Description:</p> <ul style="list-style-type: none"> • Hose connector • Autoclavable 	



Alle / Verkaufsartikel / Accessories / Uncategorized / Tubes

Luer-lock-adapter male for 4 mm tubing (package of 20 pieces)



bbi Scancode	BBI-45110205
Country of Origin	US 🇺🇸
HS-Code	3917400090
Material	PVDF

Components	20x luer lock adapter
Related Products	<p>Luer-lock-adapter female for 3.2 mm tubing (package of 20 pieces) (BBI-45110204)</p> <p>Luer-lock-adapter female for 4 mm tubing (package of 20 pieces) (BBI-45110206)</p> <p>Luer-lock-adapter male for 3.2 mm tubing (package of 20 pieces) (BBI-45110203)</p>
<p>Description:</p> <ul style="list-style-type: none"> • Hose connector • Autoclavable 	



Alle / Verkaufsartikel / Accessories / Uncategorized / Tubes

Luer-lock-adapter female for 4 mm tubing (package of 20 pieces)



bbi Scancode	BBI-45110206
Country of Origin	US 🇺🇸
HS-Code	3917400090
Weight	0.02 kg
Material	PVDF

Components	20x luer lock adapter
Related Products	Luer-lock-adapter female for 3.2 mm tubing (package of 20 pieces) (BBI-45110204) Luer-lock-adapter male for 3.2 mm tubing (package of 20 pieces) (BBI-45110203) Luer-lock-adapter male for 4 mm tubing (package of 20 pieces) (BBI-45110205)
Description: <ul style="list-style-type: none"> • Hose connector • Autoclavable 	



To the Shop:



Alle / Verkaufsartikel / Accessories / Uncategorized / Coupling nuts

Coupling nut M 10 x 1 (flat)



bbi Scancode	BBI-44130009
Manufacturer	bbi-biotech GmbH
Internal Thread	M 10 x 1
Country of Origin	DE 
HS-Code	73181562
Weight	0.04 kg
Material	Stainless steel 316L

Components	1x coupling nut
Related Products	Blind plug M 10 x 1 (BBI-44130207) Coupling nut M 10 x 1 (high) (BBI-44130010) Universal adapter 6-4 (BBI-43930003)
<p>Description:</p> <ul style="list-style-type: none"> • Spare part for all M 10 x 1-accessories • Extra flat and narrow to fit in the small footprint of a bioreactor lid • 5 mm thick 	



Alle / Verkaufsartikel / Accessories / Uncategorized / Coupling nuts

Coupling nut M 10 x 1 (high)

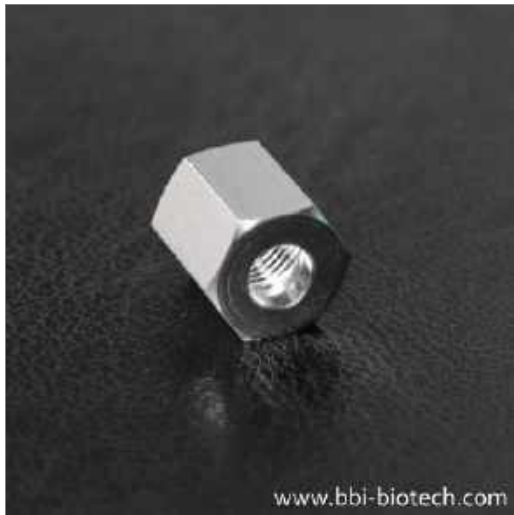

bbi Scancode	BBI-44130010
Manufacturer	bbi-biotech GmbH
Internal Thread	M 10 x 1
Country of Origin	DE 
HS-Code	73181562
Weight	0.01 kg
Material	Stainless steel 316L

Components	1x coupling nut
Related Products	<p>1 L Pt100 casing (BBI-43430021)</p> <p>Adapter for 6 mm level probes or dip tubes for harvesting in 11 mm ports (long) (BBI-44630104)</p> <p>Coupling nut M 10 x 1 (flat) (BBI-44130009)</p>
<p>Description:</p> <ul style="list-style-type: none"> • Spare part for all M 10 x 1-accessories • E.g. usable for adapter for antifoam-/level probes or heght-adjustable dip tubes with 6 mm diameter 	



Alle / Verkaufsartikel / Accessories / Uncategorized / Coupling nuts

Coupling nut G 1 1/4



bbi Scancode	BBI-44130011
Manufacturer	bbi-biotech GmbH
Internal Thread	G 1 1/4
Country of Origin	DE 
HS-Code	73269098
Weight	0.13 kg
Material	Stainless steel 316L

Components	1x coupling nut; 1x circlip
Consumables	Circlips for items to install in 25 mm Ingold ports (package of 10 pieces) (BBI-45110301)
Related Products	Blind plug 25 mm for G 1 1/4" (Ingold socket), standard length 52 mm (BBI-44130202) Coupling nut Rd 28 x 1/8 (BBI-44130012) Probe adapter 25 mm for G 1 1/4 (Ingold socket) for 12 mm probes (BBI-44130106)
Description: <ul style="list-style-type: none"> • Spare part for 25 mm-port accessories, like blind plugs 25 mm or probe adapters 25 mm • Delivery with circlip 	



To the Shop:



Alle / Verkaufsartikel / Accessories / Uncategorized / Coupling nuts

Coupling nut Rd 28 x 1/8



bbi Scancode	BBI-44130012
Manufacturer	bbi-biotech GmbH
Internal Thread	Rd 28 x 1/8
Country of Origin	DE 
HS-Code	73269098
Material	Stainless steel 316L

Components	1x coupling nut
Related Products	Blind plug for 19 mm B.Braun Safety Side Port (Ingold socket) (BBI-44130204) Coupling nut G 1 1/4 (BBI-44130011) Coupling nut M 10 x 1 (flat) (BBI-44130009)
Description:	
<ul style="list-style-type: none"> Spare part for 19 mm-side-port accessories, like blind plugs 19 mm 	



Alle / Verkaufsartikel / Service / Standard-Serviceleistungen

Maintenance of stirrer shafts up to 10 L (visual inspection)



bbi Scancode

BBI-60000201

Components	
Related Products	<p>Maintenance of stirrer shafts up to 10 L (incl. replacement of all wear parts) (BBI-60000203)</p> <p>Maintenance of stirrer shafts up to 10 L (incl. replacement of seals, without mechanical seal) (BBI-60000202)</p> <p>Replacement set of seals for stirrer shaft (0.5 - 10 L) (BBI-43930203)</p>
<p>Description:</p> <p>It is necessary to send in the stirrer shaft with a decontamination certificate.</p>	



To the Shop:



Alle / Verkaufsartikel / Service / Standard-Serviceleistungen

Maintenance of stirrer shafts up to 10 L (incl. replacement of seals, without mechanical seal)



bbi Scancode	BBI-60000202
Material Certificate	FDA
Country of Origin	DE 

Components	
Related Products	<p>Maintenance of stirrer shafts up to 10 L (incl. replacement of all wear parts) (BBI-60000203)</p> <p>Maintenance of stirrer shafts up to 10 L (visual inspection) (BBI-60000201)</p> <p>Replacement set of seals for stirrer shaft (0.5 - 10 L) (BBI-43930203)</p>
<p>Description: Maintenance of your stirrer shaft in the bbi workshop.</p> <p>Replacement of:</p> <ul style="list-style-type: none"> • O-rings • Deep groove ball bearing • Thrust washer with dowel pin • Circlips • V-seal <p>It is necessary to send in the stirrer shaft with a decontamination certificate.</p>	



Alle / Verkaufsartikel / Service / Standard-Serviceleistungen

Maintenance of stirrer shafts up to 10 L (incl. replacement of all wear parts)



bbi Scancode	BBI-60000203
Material Certificate	FDA
Country of Origin	DE 

Components	
Related Products	<p>Maintenance of stirrer shafts up to 10 L (incl. replacement of seals, without mechanical seal) (BBI-60000202)</p> <p>Maintenance of stirrer shafts up to 10 L (visual inspection) (BBI-60000201)</p> <p>Replacement set of seals for stirrer shaft (0.5 - 10 L) (BBI-43930203)</p>
<p>Description:</p> <p>Complete maintenance of your stirrer shaft in the bbi workshop.</p> <p>Replacement of:</p> <ul style="list-style-type: none"> • Mechanical seal • O-rings • Deep groove ball bearing • Thrust washer with dowel pin • Circlips • V-seal <p>It is necessary to send in the stirrer shaft with a decontamination certificate.</p>	



Alle / Verkaufsartikel / Service / Standard-Serviceleistungen

Maintenance of Biostat C/C+ stirrer shafts up to 30 L (visual inspection)



bbi Scancode	BBI-60000211
Manufacturer	bbi-biotech GmbH
Country of Origin	DE 

Components	
Related Products	<p>Maintenance of Biostat C/C+ stirrer shafts up to 30 L (incl. replacement of all wear parts) (BBI-60000213)</p> <p>Maintenance of Biostat C/C+ stirrer shafts up to 30 L (incl. replacement of seals, without mechanical seal) (BBI-60000212)</p> <p>Maintenance of stirrer shafts up to 10 L (incl. replacement of seals, without mechanical seal) (BBI-60000202)</p>
<p>Description:</p> <p>It is necessary to send in the stirrer shaft with a decontamination certificate.</p>	



Alle / Verkaufsartikel / Service / Standard-Serviceleistungen

Maintenance of Biostat C/C+ stirrer shafts up to 30 L (incl. replacement of seals, without mechanical seal)



bbi Scancode	BBI-60000212
Manufacturer	bbi-biotech GmbH

Components	
Related Products	<p>Maintenance of Biostat C/C+ stirrer shafts up to 30 L (incl. replacement of all wear parts) (BBI-60000213)</p> <p>Maintenance of Biostat C/C+ stirrer shafts up to 30 L (visual inspection) (BBI-60000211)</p> <p>Maintenance of stirrer shafts up to 10 L (incl. replacement of all wear parts) (BBI-60000203)</p>
<p>Description:</p> <p>Maintenance of your stirrer shaft in the bbi workshop.</p> <p>Replacement of:</p> <ul style="list-style-type: none"> • O-rings • Deep groove ball bearing • Thrust washer with dowel pin • Circlips • V-seal <p>It is necessary to send in the stirrer shaft with a decontamination certificate.</p>	



Alle / Verkaufsartikel / Service / Standard-Serviceleistungen

Maintenance of Biostat C/C+ stirrer shafts up to 30 L (incl. replacement of all wear parts)



bbi Scancode	BBI-60000213
Manufacturer	bbi-biotech GmbH
Country of Origin	DE 

Components	
Related Products	<p>Maintenance of Biostat C/C+ stirrer shafts up to 30 L (incl. replacement of seals, without mechanical seal) (BBI-60000212)</p> <p>Maintenance of Biostat C/C+ stirrer shafts up to 30 L (visual inspection) (BBI-60000211)</p> <p>Maintenance of stirrer shafts up to 10 L (incl. replacement of all wear parts) (BBI-60000203)</p>
<p>Description:</p> <p>Complete maintenance of your stirrer shaft in the bbi workshop.</p> <p>Replacement of:</p> <ul style="list-style-type: none"> • Mechanical seal • O-rings • Deep groove ball bearing • Thrust washer with dowel pin • Circlips • V-seal <p>It is necessary to send in the stirrer shaft with a decontamination certificate.</p>	



Alle / Verkaufsartikel / Service / Standard-Serviceleistungen

Preventive Maintenance of autoclavable vessels up to 10 L (without replacement of gaskets)



bbi Scancode	BBI-60000221
Manufacturer	bbi-biotech GmbH

Components

Description:

Präventive Wartung von Autoklavierbaren Gefäßen bis 10 L

- Sicht-Inspektion Gefäß inkl aller Einbauten und Dichtungen
- Sicht-Inspektion Welle inkl Dichtungen, Kugellager und Gleitring-Dichtung

It is necessary to send in the stirrer shaft with a decontamination certificate.



To the Shop:



Alle / Verkaufsartikel / Service / Standard-Serviceleistungen

Preventive Maintenance of autoclavable vessels up to 10 L (incl. replacement of gaskets, without gaskets)



bbi Scancode	BBI-60000222
Manufacturer	bbi-biotech GmbH
Country of Origin	DE 

Components	
Related Products	<p>Preventive Maintenance of autoclavable vessels up to 10 L (without replacement of gaskets) (BBI-60000221)</p> <p>Wear parts for stirrer shafts up to 10 L (BBI-60000205)</p> <p>Wear parts for stirrer shafts up to 10 L (without mechanical seal) (BBI-60000204)</p>
<p>Description:</p> <p>Präventive Wartung von Autoklavierbaren Gefäßen bis 10 L</p> <ul style="list-style-type: none"> • Sicht-Inspektion Gefäß inkl aller Einbauten und Dichtungen • Sicht-Inspektion Welle inkl Dichtungen, Kugellager und Gleitring-Dichtung • Austausch aller Dichtungen und O-Ringe <p>It is necessary to send in the stirrer shaft with a decontamination certificate.</p>	





bbi-biotech GmbH
Ernst-Lau-Str. 5
12489 Berlin
Germany

Tel.: +49 (30) 221 800 10
E-Mail: shop@bbi-biotech.com
Web: www.bbi-biotech.com



Visit our Website
www.bbi-biotech.com

innovation for biotech